



# **RADCITY<sup>®</sup> 5 PLUS**

## **OWNER'S MANUAL**



# Welcome to the Radventure!

Thank you for purchasing the RadCity® 5 Plus from Rad Power Bikes™!

We take pride in bringing you a quality product that will offer years of enjoyment. Please read and understand this manual fully before assembling and riding your bike; the latest version of your manual is available at [www.radpowerbikes.com/manual](http://www.radpowerbikes.com/manual). And be sure to watch the official RadCity assembly video available at [www.radpowerbikes.com/assemble](http://www.radpowerbikes.com/assemble) or at the QR code shown here.



Additional information about your RadCity can be found in our Help Center at [www.radpowerbikes.com/help](http://www.radpowerbikes.com/help).

Be sure to check all hardware for correct torque (see [“Tools and recommended torque values” on page 8](#)) during assembly. Before each ride, follow the recommendations in the [“Safety checklists” on page 27](#). Finally, take care of your new RadCity by following the guidelines in [“Recommended service intervals” on page 29](#). If you're not sure you have the skills, experience, and special tools required for assembly and maintenance, get help from a local, certified, and reputable bike mechanic.

**WE ARE HERE TO HELP!** If you have questions after reading this manual and watching the assembly video, please consult the Rad Power Bikes Help Center, contact us by email, and/or give us a call on the phone. **Thanks for riding Rad!**

Rad Power Bikes Help Center: [www.radpowerbikes.com/help](http://www.radpowerbikes.com/help)  
help request form: [www.radpowerbikes.com/support](http://www.radpowerbikes.com/support) (typically faster than email)  
e-mail: [support@radpowerbikes.com](mailto:support@radpowerbikes.com)  
phone: 1-800-939-0310

## Contents

Using this manual .....	2
Assembly instructions for the RadCity .....	2
Tools and recommended torque values .....	8
Adjusting for comfort and safety .....	10
Battery information .....	14
Operation .....	19
Carrying cargo or a child .....	25
Maintenance .....	27
Troubleshooting .....	33
Ride as safely as possible .....	35
Limited warranty and other terms .....	38

# Using this manual

This manual contains critical details about how to safely operate and maintain your RadCity. Read it carefully and familiarize yourself with your ebike before riding it. Pay special attention to the safety messages shown here.

**NOTICE:** A “notice” is important information that can help you avoid bike/property damage or extend the life of parts and the bike.

**CAUTION:** A “caution” statement indicates a hazardous situation that, if not avoided, could result in minor or moderate injury or property damage.

**WARNING:** A “warning” statement indicates a hazardous situation that, if not avoided, could result in death, serious injury, or property damage.

**DANGER:** A “danger” statement indicates a hazardous situation that, if not avoided, has a very high risk of death, serious injury, or property damage.

Riding any bike or other vehicle always involves some risk of serious injury or death. Your safety depends on many factors including your bike knowledge, your bike’s maintenance, foreseeable riding conditions, etc. There are also factors we cannot control or anticipate in every situation or condition while riding. This manual makes no representations about the safe use of bikes under all conditions. If you have any questions you should contact Rad Power Bikes immediately.

Assembly and first adjustment of your bike from Rad Power Bikes requires special tools and skills. We recommend that you have this done by a certified, reputable bike mechanic. Keep this manual and any other documents that came with your RadCity. All content in this manual is subject to change or withdrawal without notice. Visit [www.radpowerbikes.com/manual](http://www.radpowerbikes.com/manual) to view and download the latest version. Rad Power Bikes makes every effort to ensure the accuracy of its documentation and assumes no responsibility or liability if any errors or inaccuracies appear within.

## Assembly instructions for the RadCity

The following steps provide an overview of how to assemble your RadCity 5 Plus from Rad Power Bikes. They are not a complete or comprehensive manual of all aspects of assembly, maintenance, and repair, which involve specialized tools and skills. We recommend you consult a certified, reputable bike mechanic to assist in the assembly, repair, and maintenance of your RadCity.

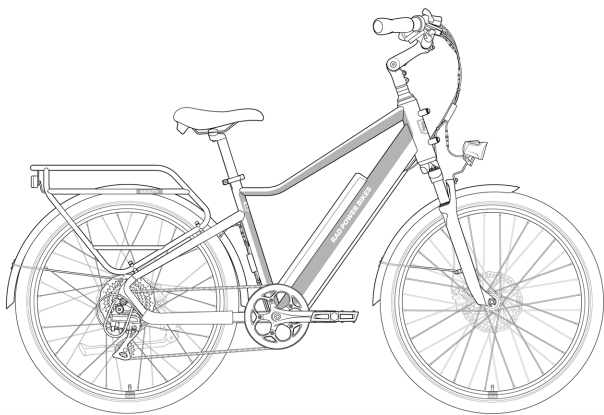

Fully assembled RadCity 5 Plus High-Step

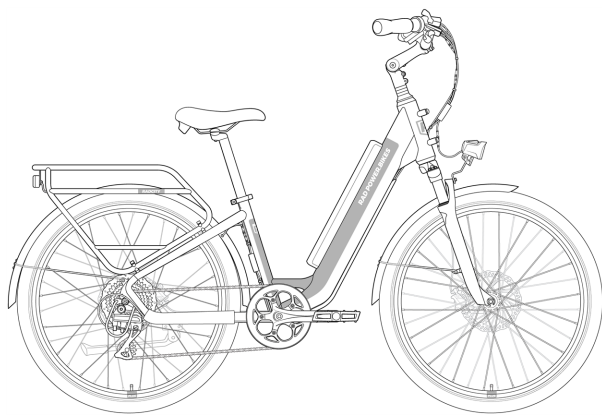

Fully assembled RadCity 5 Plus Step-Thru

Please note that your RadCity may include components that look different from those in the illustrations above and elsewhere in this manual. Such changes help ensure uninterrupted shipping. Our engineers rigorously test each component to guarantee quality and compatibility.



**WARNING:** Incorrect assembly, maintenance, or use of your ebike can cause component or performance failure, loss of control, serious injury, or death. Even if you're an experienced bike rider, **you must read and understand the entire manual and any documentation provided for subcomponents or accessories before riding.** If you are not sure you have the experience, skills, and tools to correctly perform all assembly steps in the manual and the assembly video at [www.radpowerbikes.com/assemble](http://www.radpowerbikes.com/assemble), consult a local, certified, reputable bike mechanic.

1. **Unpack the bike.** Open the bike box and, with the help of another person capable of safely lifting a heavy object, remove the ebike from the bike box, placing it upright on the back wheel and front fork protector plate. Carefully remove the packaging material protecting the bike frame and components, and keep the packaging materials in case you want to ship the bike. Otherwise, recycle these materials, especially cardboard and foam, wherever possible. Remove the small box from the bottom of the bike box and carefully set out the contents. **Ensure all of the following pieces are included with the ebike:**

- Front wheel
- Front fender
- Charger
- Headlight
- Headlight and fender mounting hardware
- Pedals (left and right)
- Keys
- Manual(s)
- Front wheel quick release (in fork protector plate)
- Stem bolt hole cover
- Assembly toolkit

If anything is missing, please contact Rad Power Bikes.

We also recommend the following (not included) for assembly and maintenance:

- A strong friend
- Flat-side cutters
- 15 mm pedal wrench
- Bicycle grease
- Clean shop towel or paper towel for cleaning excess grease
- Bike pump with Schrader valve and pressure gauge
- Torque wrench (3 Nm-60 Nm) with Allen bits

2. **Install the handlebar** as shown in the RadCity assembly video available at [www.radpowerbikes.com/assemble](http://www.radpowerbikes.com/assemble).
- a. **Determine whether you can reach the internal top-cap bolt with the long 5 mm Allen wrench**, shown as "C" in the illustration "[Stem/handlebar installation](#)" on the next page. If the top-cap bolt is not visible, loosen the side stem angle adjustment bolt (see "[Stem angle adjustment bolts](#)" on the next page) and remove the other stem angle adjustment bolt (on the underside of the stem). Rotate the stem until the top cap bolt can be reached with the long 5 mm Allen wrench.
  - b. **Orient the handlebar** so the brake levers face forward and the shifter is on the rider's right side. Trace the brake housing from the left brake lever to the brake caliper and make sure the bundle of cables is not twisted.
  - c. **Center the stem and handlebar assembly onto the steerer tube.** Slide the stem onto the tube fully. If the stem does not slide down easily, loosen the stem clamp bolts (see "B" in "[Stem/handlebar installation](#)" on the next page) by about two turns and try again (5 mm Allen wrench).
  - d. **Tighten the internal top cap bolt using the long 5 mm Allen wrench.** Insert the long end of the tool into the top of the stem and into the top cap bolt head (see "C" in "[Stem/handlebar installation](#)" on the next page). Turn clockwise just until the wrench becomes a bit harder to turn, and then turn the wrench another half-turn more.
  - e. **Check that the headset is tight enough.** Press on the back or side of the stem and try to move it back and forth. There should be no movement inside the stem indicating the headset is tight enough for the next assembly steps. Later in the process you will test and fine-tune the headset tightness for riding.
  - f. **Tighten the stem clamp bolts evenly (Allen wrench).** Orient the handlebar so that it is perpendicular to the frame. Tighten the stem clamp bolts one-quarter turn at a time, alternating between bolts until torqued evenly to the value in "[Tools and recommended torque values](#)" on page 8.

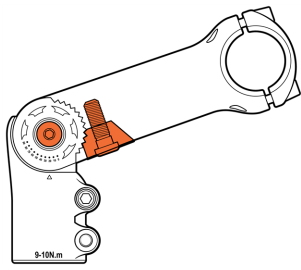

Stem angle adjustment bolts (side and bottom, in orange)

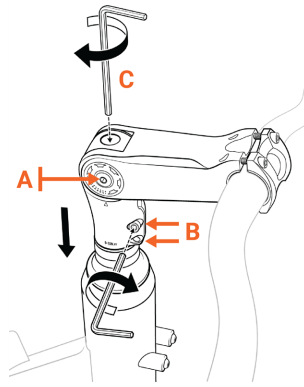

**Stem/handlebar installation**

**A:** Stem angle adjustment bolt (side)

**B:** Stem clamp bolts

**C:** Long 5 mm Allen wrench just above the top cap bolt.

- g. **Position the handlebar correctly on the stem.** Your handlebar came loosely attached to the stem of your bike, so before you secure it, make sure it's centered on the stem and that the handlebar grips will be approximately parallel to the ground when the front wheel is installed. (You can fine-tune the positioning later.)
- h. **Tighten the stem faceplate bolts.** Use an Allen wrench to tighten each of the faceplate bolts by a quarter turn, following an "X" pattern. Repeat until the handlebar is secure. Ensure the gap between the faceplate and stem is even. Torque the bolts evenly to the value listed in ["Tools and recommended torque values" on page 8.](#)

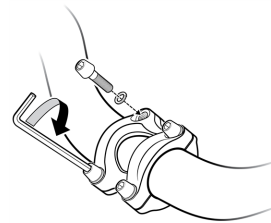

Stem faceplate installation

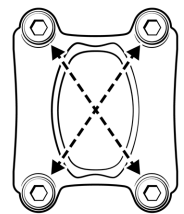

Tighten bolts in an "X" pattern

- 3. **Install the front wheel onto the front fork** as explained below. For more information, see the assembly video at [www.radpowerbikes.com/assemble](http://www.radpowerbikes.com/assemble).



**WARNING:** Do not touch the brake rotor, which has sharp edges and can cause serious injury. Touching the brake rotor or brake pads with bare skin can also transfer natural oils to either component, which can decrease braking performance. When installing the front wheel, ensure that you don't touch the brake rotor or pads with bare hands. Wear clean gloves if needed.



- a. **Locate and remove the quick-release skewer from the front fork protector plate.** Open the lever, remove the thumbnut and cone spring on the opposite side, and remove the skewer. Keep the washer and the other cone spring in place on the lever side.
- b. **Lightly grease the quick-release skewer.** Place about half of a pea-size amount of bicycle grease onto the threaded end of the skewer and then wipe it across the rest of the skewer.
- c. **Install the skewer through the front wheel hub, starting from the brake-rotor side.** Make sure to not touch the brake rotor. Reinstall the cone spring on the skewer. Ensure both cone springs point inward. Keep the lever open and thread on the thumbnut a couple of turns, leaving enough room for the fork dropouts.
- a. **Remove the hydraulic brake pad spacer** from the brake caliper on the front wheel.

**NOTICE:** If the front wheel is not installed or if the hydraulic brake pad spacer is missing, do NOT squeeze the brake levers. Doing so can cause the brake pads to clamp together too much and prevent the brake rotor from fitting between the pads. If this happens to you, install the brake pad spacer back between the pads to create more space between the brake pads for the brake rotor. More information is available in our Help Center at [www.radpowerbikes.com/help](http://www.radpowerbikes.com/help).

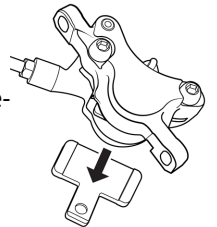

- b. **Carefully lift the front of the bike and lower the fork onto the wheel** so that the brake rotor enters the caliper, between the brake pads, and the axle enters the fork dropouts fully. If installing the front wheel is

difficult, reinsert the pad spacer to create more space between the brake pads for the brake rotor. Then remove the spacer and install the wheel. If installing the front wheel is difficult, use a 5 mm Allen wrench to turn the inner pad adjustment dial counterclockwise one or two clicks to increase the space between the brake pads. Try to install the wheel again.

c. Check that the wheel is fully seated in the dropouts, that the wheel axle is level and parallel to the ground, and that the wheel is centered.

d. Hold the quick-release lever in line with the axle and tighten the thumbnut until the lever can stay parallel to the floor without being held. Use the palm of your hand to close the lever fully, without touching the brake rotor. The quick-release lever secures the front wheel to the bike, so it's important that the thumbnut is tight enough that the closed lever has adequate clamping force to keep the axle and wheel firmly in place. When you close the lever, there should be enough resistance that it leaves an imprint in your hand.

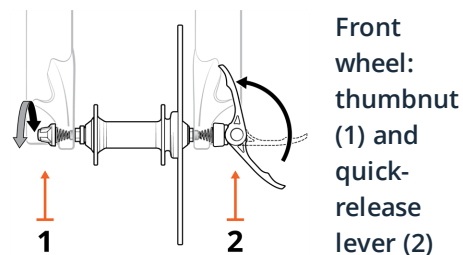

e. Prop the bike on the kickstand.

f. Check the security of the front wheel and quick-release lever. If it's too easy or too difficult to close, adjust the lever tension by turning the thumbnut one turn, then close the lever. Check the front wheel security on a regular basis: the front wheel should always be fully seated in the dropouts of the front fork, and the quick-release lever should always be properly secured.

4. Check the security of the rear wheel. The rear wheel security and hardware torque should also be checked on a regular basis (see [“Tools and recommended torque values” on page 8](#)). Either wheel can become loose or unsecured with normal use.

**WARNING:** An improperly secured front or rear wheel can cause loss of control, accidents, serious injury, or death. Check that both wheels are properly secured during assembly and before each ride.

5. Install the front fender and headlight.

a. Remove the front fender from the rear of the bike.

b. Locate the bag with the fender and headlight mounting hardware.

c. Pass the fender from the back of the front wheel, under the fork arch, as shown below.

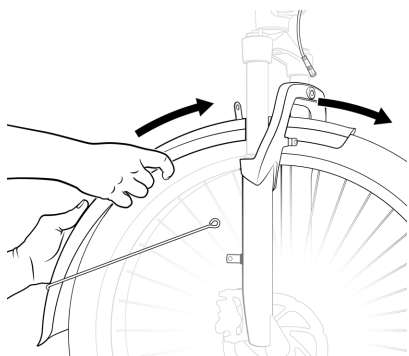

Pass the fender from the back of the front wheel

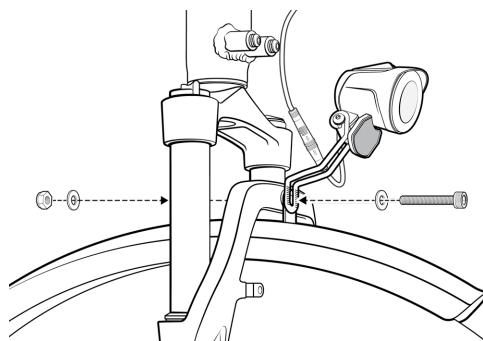

Headlight mounting hardware

d. Install the fender/headlight mounting hardware through the headlight bracket, fender, and fork (5 mm Allen wrench and 10 mm wrench).

e. Plug in the headlight connector. Line up the internal notch and pins and external arrows, and press directly together without twisting.

f. **Locate the fender bracket and mounting bolts.** If needed, thread in the bolt to attach the fender mounting bracket to the mounting point on the back of the fork, then tighten securely (Allen wrench). Repeat with the other bracket on the other fork lower.

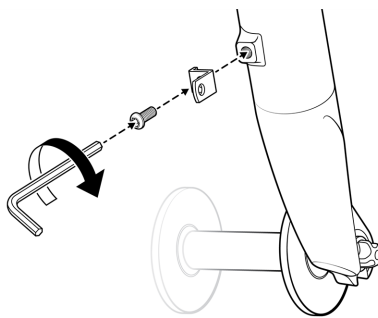

Installing the fender mounting bracket

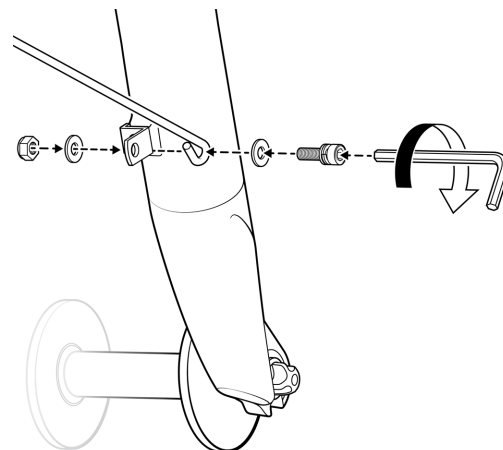

fender mounting hardware

g. **Ensure the fender mounting bracket is oriented properly on the mounting point on the fork lower** as shown in the illustrations.

h. **Secure the fender mounting arms.** Pass a split washer and then a flat washer onto the bolt end. Place the fender arm over the mounting hole on the outside of the bracket. Thread the bolt through the fender mounting arm. On the other side of the bracket, thread on a washer and locknut by hand as shown in the "fender mounting hardware" illustration. Tighten securely (4 mm Allen wrench and 8 mm wrench).

i. **Check that the fender and headlight are centered,** then torque the fender mounting arm bolts according to the value in ["Tools and recommended torque values" on page 8.](#)

j. **Adjust the headlight angle slightly downward** so it will not blind oncoming traffic. Use the tools listed in ["Tools and recommended torque values" on page 8](#) to loosen the angle adjustment bolt and locknut, angle the headlight downward, then tighten securely. Do not overtighten.

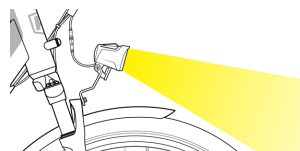

Headlight pointing slightly downward to not blind others

## 6. Install the pedals.

a. **Locate the right-side pedal,** which is marked "R," should have an "R" sticker attached, and has a smooth pedal axle. The right pedal goes on the crank on the drivetrain side of the bike, which has the chain and is the same as a rider's right side when seated on the bike.

### RIGHT PEDAL INSTALLATION

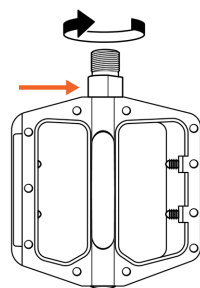

Right pedal with smooth pedal axle.

b. **Place a pea-size or slightly smaller amount of bicycle grease onto the threads of the right pedal.**

c. **Carefully thread the right pedal onto the right crank by turning clockwise** (toward the front of the bike). Do so slowly and gently by hand. Do not cross thread or damage the threads. See the ["Right pedal installation"](#) illustrations.

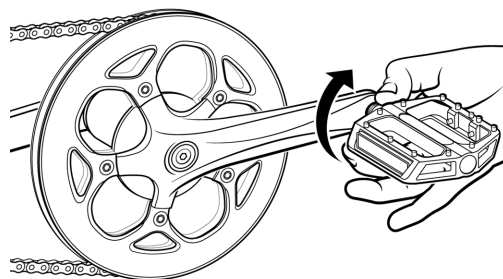

Thread the right pedal onto the right crank gently by hand, turning clockwise.

- d. Place a pea-size or slightly smaller amount of bicycle grease onto the threads of the left pedal.
  - e. Carefully thread the left pedal onto the left crank by turning counterclockwise (toward the front of the bike). The reverse-threaded left pedal is marked with an "L," should have an "L" sticker attached, and has notches on the pedal axle. Thread slowly and gently by hand without cross-threading or damaging the threads. See the "[Left pedal installation](#)" illustrations.
  - f. Tighten each pedal using a pedal wrench to avoid damage caused by wider wrenches, as shown in the assembly video at [www.radpowerbikes.com/assemble](http://www.radpowerbikes.com/assemble).
  - g. Torque each pedal to 35 Nm.
  - h. Wipe off any excess bicycle grease.
7. **Inflate tires.** Check that the tire beads and tires are evenly seated around the rims. Use a pump with a Schrader valve and pressure gauge to inflate each tire to the recommended PSI (pounds per square inch) indicated on the tire sidewall. Do not overinflate or underinflate tires. For more information, see "[Tire and wheel care](#)" on page 31.

## LEFT PEDAL INSTALLATION

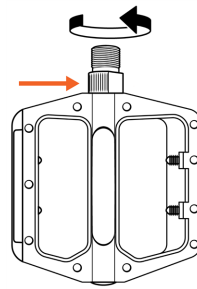

Left pedal with notches on the pedal axle.

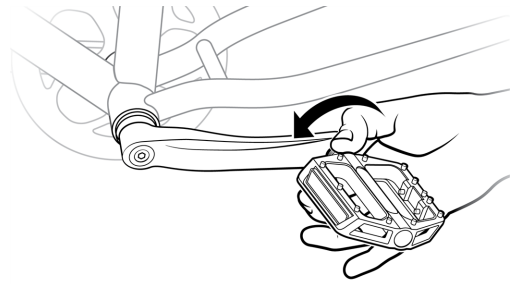

Thread the left pedal onto the left crank gently by hand, turning counterclockwise.

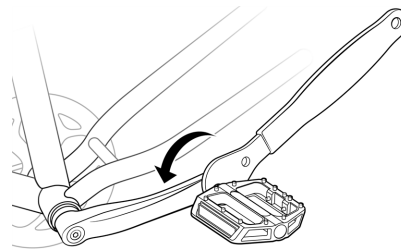

Pedal wrench on left pedal

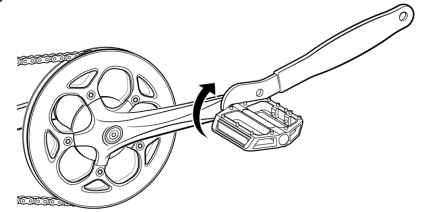

Pedal wrench on right pedal

8. **Prepare your ebike's power system for use.** Your bike has been configured to ensure power isn't deployed to the motor during shipping. To ensure your ebike is ready for use, you will need to do one or both of the following:

- **Plug in the display connector.** Your display connector may come unplugged. If it does, you will find one of the cables at the front of the bike disconnected (it will have green connector ends). Line up the internal notch and pins, and external arrows, and press together without twisting.
- **Take your battery out of ship mode.** If your display connector comes connected, your battery is probably in ship mode to prevent accidental activation prior to assembly. To take it out of ship mode, press and hold the battery button for at least three seconds.

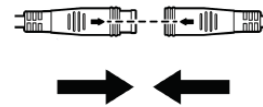

Align the arrows on the Display Connector

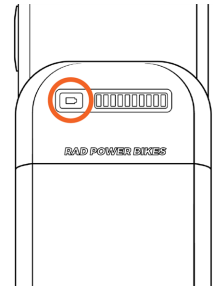

Battery button

9. **Complete all steps in "[Adjusting for comfort and safety](#)" on page 10**, including checking that all hardware has been tightened according to the values in "[Recommended torque values](#)" on page 1. Before your first ride, be sure to perform the safety checks in "[Maintenance](#)" on page 1 including the handlebar twist test in "[Handlebar twist test](#)" on page 1.



# Tools and recommended torque values

The tool sizing listed below is a general guide, but it is possible that the head of a particular bolt on your bike may vary, requiring a different tool (e.g., a 4 mm Allen wrench instead of a 5 mm Allen wrench). If so, use whatever tool fits the bolt head. Such differences will not affect the recommended torque for that piece of hardware. If you are installing accessories from Rad Power Bikes, any necessary instructions, important safety information, and torque specifications will come with your accessory and/or be available online at [www.radpowerbikes.com/help](http://www.radpowerbikes.com/help).

		Tool	Rec. torque
Handlebar area	Stem clamp bolts	5 mm Allen	10 Nm
	Stem faceplate bolts	5 mm Allen	6 Nm
	Stem angle adjustment bolt ( <b>side</b> )	5 mm Allen	12 Nm
	Stem angle adjustment bolt ( <b>bottom</b> )	5 mm Allen	15 Nm
	Rad UI Display clamp bolts	3 mm Allen	3 Nm
	Rad UI Remote clamp bolt	3 mm Allen	3 Nm
	Throttle clamp bolt	3 mm Allen	3 Nm
	Shifter clamp bolt	Phillips or flat head	6 Nm
	Brake lever clamp bolts	5 mm Allen	6 Nm
Brake area	Caliper adapter to frame	5 mm Allen	6–8 Nm
	Caliper to adapter	5 mm Allen	6–8 Nm
	Brake pads to caliper	Cotter pin	n/a
	Brake rotor to hub	T25 Torx bit	7 Nm
Seat area	Seat adjustment bolt	6 mm Allen	15 Nm
Frame downtube	Controller mounting bolts	3 mm Allen	3 Nm
	Frame cable cover bolts	2.5 mm Allen	tighten securely; do not overtighten
Rear dropout area	Rear axle nuts	18 mm wrench	40 Nm
	Torque arm bolt	4 mm Allen	5 Nm
	Derailleur hanger mounting bolt	5 mm Allen	10 Nm
	Derailleur mounting bolt	5 mm Allen	10 Nm
	Derailleur cable clamp bolt	5 mm Allen	6–8 Nm
Bottom bracket and crank area	Pedal into crank arm	15 mm pedal wrench	35 Nm
	Crank arm removal info	Crank puller for square taper bottom bracket	n/a
	Crank arm bolt into bottom bracket spindle	8 mm Allen	35 Nm
	Freewheel removal information	Contact Rad Power Bikes Product Support	n/a
	Chainring bolts	5 mm Allen	10 Nm
	Kickstand mounting bolts	5 mm Allen	8 Nm
	Bottom bracket and cups	BBT-22 Park Tool	60 Nm

Accessories	Headlight/front fender mounting bolt	5 mm Allen and 10 mm wrench	6 Nm
	Fender mounting bolts (except at headlight)	4 mm Allen	6 Nm
	Replaceable rear rack mounting bolts	5 mm Allen	6 Nm

# Adjusting for comfort and safety

The following steps are critical for your comfort and safety, and **must** be performed before your first bike ride. We recommend that you consult a bike fitting professional such as a certified, reputable bike mechanic who specializes in bike fit.

## Adjusting the seat angle and horizontal position

Many riders will prefer the seat to be roughly parallel to the ground, with its horizontal position in the middle of the range marked on the seat rails. To change the angle and horizontal position of the seat:

1. Use a 6 mm Allen wrench to loosen (but do not remove) the seat adjustment bolt on the clamp located underneath the seat.
2. Move the seat backward or forward and tilt to adjust the angle. Do not exceed the limit markings etched into one of the seat rails, which show how far you can safely move the seat forward and backward.
3. Ensure the top of the seat rail clamp is aligned directly over the bottom of the clamp so that the seat adjustment bolt will clamp the seat rails properly. Then, while holding the seat in the desired position, use a 6 mm Allen wrench to tighten the seat adjustment bolt securely to the torque value listed in [“Tools and recommended torque values” on page 8](#).

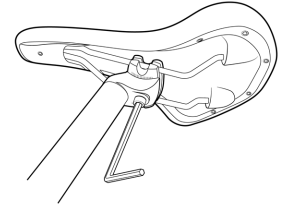

Seat adjustment bolt with Allen wrench

**WARNING:** A loose seat clamp or seat adjustment bolt can cause loss of control, bike/property damage, serious injury, or death. Prior to first use, be sure to tighten the seat clamp via the seat adjustment bolt properly. Regularly check to make sure that the seat adjustment bolt is properly tightened and the clamp is secure on the seat rails.

## Adjusting the seat height

An ideal seat height for most riders allows them to be comfortable and get the best pedaling efficiency. When the rider is seated, they should be able to place the ball of their foot on the pedal at its lowest position while their leg is almost fully extended, with the knee slightly bent. The seat should never be so high that the rider must rock side to side or fully straighten their legs while pedaling. And the seat must never be pulled out so far that the minimum insertion point is above the seat tube (see illustration).



Seatpost out **TOO FAR**  
The minimum insertion point on the seatpost must be inserted into the seat tube.

Depending on a rider's preference, ability, and amount of experience with bike and ebike riding, lowering the seat so the rider can put one or both feet on the ground without dismounting from the seat may offer a safer and more comfortable experience while operating the bike.

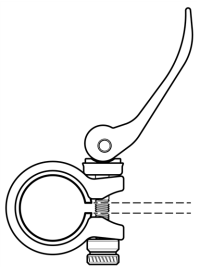

Open the quick-release lever

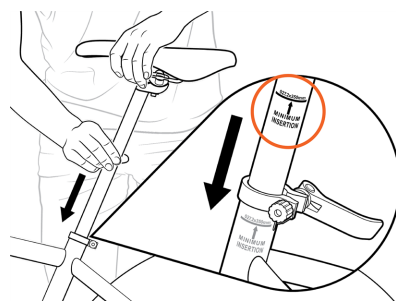

Insert the seatpost, ensuring the minimum insertion point (circled in orange) goes into the seat tube.

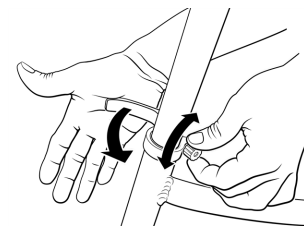

Close the quick-release lever using your palm.

1. Open the seatpost quick-release lever.
2. Slide the seatpost in or out of the seat tube to a height appropriate for your leg length and preference. *Do not extend the seatpost beyond the minimum insertion marking etched onto the seatpost* (see the [“Seatpost out TOO FAR”](#) illustration).

3. Align the quick release clamp opening with the notch in the seat tube, and close the quick-release lever fully. Closing the lever should require enough pressure that it leaves an imprint in your hand. When closed, the seat should not move up, down, left, or right. If needed, adjust the lever tension by turning the adjustment nut opposite the quick-release lever.
4. Try out your seat fit, and repeat steps 1–3 if the seat position needs a bit more adjusting.

**! DANGER:** Overextending the seatpost can cause it to break or fall off your bike, which will put you at very high risk of serious injury or death. Avoid this danger by inserting your seatpost into the seat tube far enough that the minimum insertion point is no longer visible.

## Fine-tune the handlebar stem angle

For maximum comfort, riders should not overextend their arms' reach when riding. Ensure that the position and angle of the stem, handlebar, and brake levers allow for a comfortable arm position, with a relatively straight line along the forearms, wrists, and hands. The rider must also be able to turn the handlebar side to side without strain or getting hit by the handlebar.

1. Loosen the stem angle adjustment bolt (bottom) under the stem two full turns (Allen wrench). See "Stem angle adjustment bolts" illustration.
2. Loosen the stem angle adjustment bolt (side) one-half turn (Allen wrench). See "Stem angle adjustment bolts" illustration.
3. Adjust the angle of the stem according to rider proportions and preference.
4. Tighten the stem angle adjustment bolts. First tighten the side bolt, then the bottom. Both should be torqued to the values listed in ["Tools and recommended torque values" on page 8](#).

**! WARNING:** Do not operate the bike without ensuring the stem is secured to the headset and handlebar and that all bolts are torqued to the values in ["Tools and recommended torque values" on page 8](#).

**! DANGER:** Overextending components like the handlebar stem, seatpost, or seat can cause those components to break or fall off your bike, which will put you at very high risk of serious injury or death. Avoid this danger by never extending these components beyond any minimum insertion markings etched into the components.

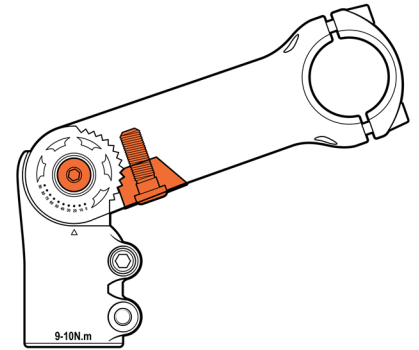

Stem angle adjustment bolts (side and bottom, in orange)

## Fine-tune the headset tightness

The headset is the portion of the bike inside the headtube that connects the front fork to the handlebar stem.

**Check whether the headset is too loose.** To test that the headset is tight enough, place one hand over the spot where the handlebar stem meets the bike's headtube. With the other hand squeezing the front brake lever (left side of handlebar), gently rock the bike front to back. If your headset is too loose, you'll feel a knocking sensation.

**Check whether the headset is too tight.** Hold onto your top tube and lift the front wheel off the ground slightly. Your front wheel should be able to flop if you tilt the bike to the side without your hands on the handlebar.

To add or reduce tension, follow these steps.

1. If necessary, remove the stem bolt hole cover. Set aside for reinstallation later.
2. Access the top cap bolt. If needed, loosen the angle adjustment bolts (see ["Stem angle adjustment bolts" above](#)) and angle the stem to allow top cap bolt access. Insert the extra-long 5 mm Allen wrench into the top cap bolt head. (See "B" in ["Fine-tune the headset tightness" on the next page](#).)
3. Evenly loosen the stem clamp bolts (see "A" in ["Fine-tune the headset tightness" below](#)).

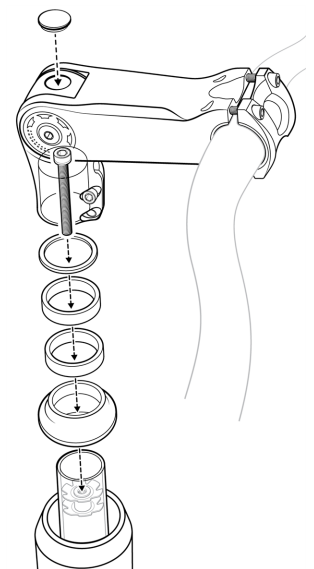

Stem and headset components

4. Turn the top cap bolt 1/4 turn using the extra-long 5 mm Allen wrench.
5. Test whether the headset is too loose or too tight as described above.
6. If needed, repeat steps 4 and 5 until you have achieved ideal headset tightness.
7. Tighten the stem clamp bolts evenly. Turn each bolt one quarter turn, alternating bolts, until both are secure. Torque to the value listed in [“Tools and recommended torque values” on page 8](#)
8. Fine-tune the handlebar stem angle if needed. See [“Fine-tune the handlebar stem angle” on the previous page](#).
9. Install the stem bolt hole cover.
10. Perform a handlebar twist test to ensure the front wheel and handlebar stem are securely connected. See [“Handlebar twist test” on page 32](#) for instructions.

If you're unsure whether you have tightened the headset correctly, consult a certified, reputable bike mechanic.

Over time, the headset can loosen. Periodically check the headset tightness and, if necessary, adjust the top cap bolt as explained above.

**CAUTION:** Riding a bike with a headset that is too loose or too tight can cause damage to the headset and other bike components. To prevent this damage, periodically check your headset for ideal tightness.

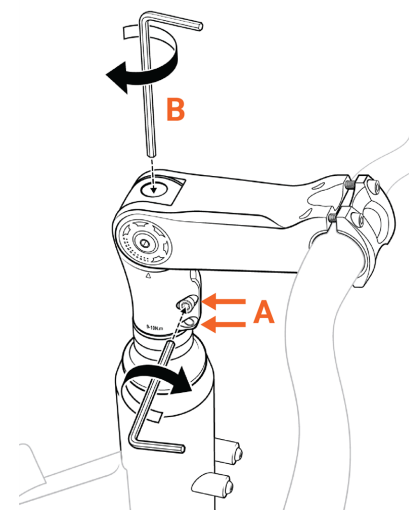

Fine-tune the headset tightness

## Adjust the angle of the Rad UI Display and UI Remote

For best screen visibility and to prevent glare, angle the Rad UI Display and Rad UI Remote so that they are not facing directly at the rider, but are tilted slightly away.

1. Loosen the Rad UI Display clamp bolts. Loosen just until the UI Display can rotate on the handlebar. Do not remove the bolts.
2. Rotate the Rad UI Display and test the positioning. The angle that will minimize glare and optimize visibility of the screen will depend on the rider's height and biking position. The screen should be tilted away from the rider but not tilted so far that it's horizontal. Test the position while seated on your bike outdoors, in sunlight. Adjust as desired.
3. Tighten the Rad UI Display clamp bolts. Tighten to the torque value listed in [“Tools and recommended torque values” on page 8](#).
4. Adjust the position of your Rad UI Remote using steps 1 to 3 above.

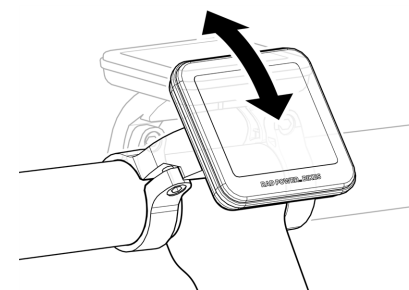

Angle the Rad UI Display to minimize glare

## Fine-tune the brake lever positioning

The angle of the brake levers can be adjusted for the most comfortable hand position possible. For most riders, this will allow them to rest two or three fingers comfortably on the brake lever while keeping their wrists in a neutral position. To adjust the angle, follow these steps:

1. Loosen the brake lever clamp bolt (bottom arrow in the “Brake bolts” illustration) using the appropriate Allen wrench.
2. Adjust the angle of the brake lever so it's comfortable for the rider.
3. Retighten the brake lever clamp bolt according to the value listed in [“Tools and recommended torque values” on page 8](#).

### BRAKE BOLTS

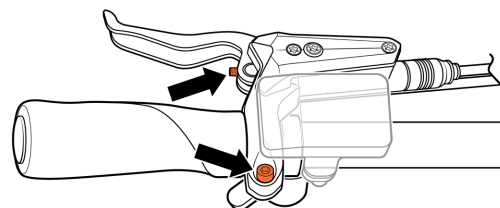

Top arrow: Brake lever adjustment bolt  
Bottom arrow: Brake lever clamp bolt

You can also adjust how close the brake levers are to the handlebar grips. Ideally, when you are riding your bike, you should be able to have your hands holding the handlebar grips comfortably while also keeping two or three fingers on the brake lever, ready to squeeze the brakes without extending your grip uncomfortably. For most

riders, the default position of the brake levers will be comfortable. For others, especially those with small hands, sensitive thumb joints, etc., it may be more comfortable to move the brake levers closer to the handlebar. Here's how.

1. **Locate the brake lever adjustment knob** on the brake lever body (the top arrow in the illustration [“Brake bolts” on the previous page](#)).
2. **Rotate the knob** toward the rider to move the lever closer, or rotate the knob away from the rider to move the lever farther away.

 **DANGER:** A brake lever that can touch the handlebar grip when squeezed can result in the brake caliper not pressing the pads into the brake rotor fully or at all, which means that the brake will not function properly or at all. Not being able to brake the bike puts the rider at a high risk of serious injury or death. Always make sure that squeezing the brake lever does not cause it to touch the handlebar grip. Also make sure that a squeeze of the brake lever to halfway between the lever's neutral position and the handlebar grip results in the brake caliper pressing the brake pads against the brake rotor.

---

## Adjust the suspension fork

The suspension fork can move up and down to cushion bumps in the riding surface, which can make riding on a rough road or trail smoother and more comfortable. Depending on a rider's weight or preference, preload (suspension fork spring compression) can be adjusted. Adding preload will make the suspension stiffer, which can be better for heavier riders or those who prefer a stiffer, more efficient ride. Subtracting preload will make the suspension softer, which can be best for lighter riders or those who prefer maximum cushioning from bumps in the riding surface.

 **WARNING:** A low preload setting (for a “softer” ride) can cause your fork to compress when you brake, and the effect will be more dramatic for heavier riders and at higher speeds. If the fork compresses suddenly, that could cause loss of balance or a fall, resulting in serious injury or death. We recommend you start riding with a higher preload setting. If you want to try a lower preload, practice riding at that setting in a safe location (flat and free of hazards that might require sudden braking) and begin at low to moderate speeds.

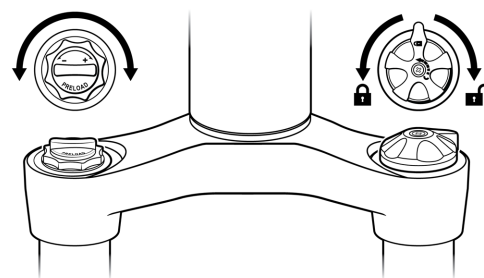

Suspension fork

Depending on a rider's preference, the suspension fork can also be locked out as a rigid fork, which will typically yield higher efficiency while pedaling.

**To completely lock the suspension fork**, turn the lockout lever, located on the suspension fork, in the direction of the arrow until it stops. To unlock the suspension fork, turn the lever in the other direction until it stops.

To adjust the resistance of the suspension fork, follow these steps:

1. **Make sure the lockout lever is unlocked.**
2. **Turn the preload adjustment knob** (located on the suspension fork and labeled “preload”). To make the suspension softer, subtract resistance by turning the preload adjustment knob in the direction of the small “-” on the knob. To make the suspension stiffer, add resistance by turning the preload adjustment knob in the direction of the small “+” on the knob.

For more information on adjusting suspension forks, please see our Help Center at [www.radpowerbikes.com/help](http://www.radpowerbikes.com/help).

---

## Ensure all hardware is tightened properly

Ensure all hardware is tightened properly according to the values in [“Tools and recommended torque values” on page 8](#). **This is a critical safety step that you must not skip.** If you do not own a torque wrench or you do not have the skills to check the tightness of your hardware, consult a local, certified, reputable bike mechanic for help. You can find more information about bike fit and making adjustments to your bike in our Help Center at [www.radpowerbikes.com/help](http://www.radpowerbikes.com/help).

# Battery information

The battery that comes with your RadCity is a state-of-the-art, lithium-ion battery that's designed to give you years and thousands of miles of Rad riding. Like any powerful battery, it requires appropriate care to ensure safety and best performance. For your safety and the safety of your ebike, you must read this entire section and follow its recommendations.

## Battery introduction

Please familiarize yourself with all of the components of your battery, the battery mount on your bike, and your charger.

### Rad battery in its mount

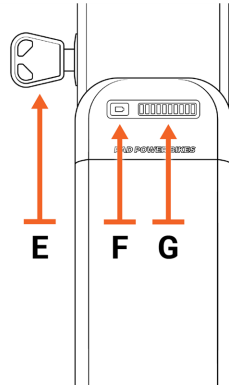
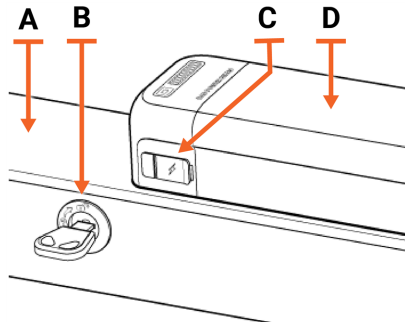

### Rad battery with charging plug

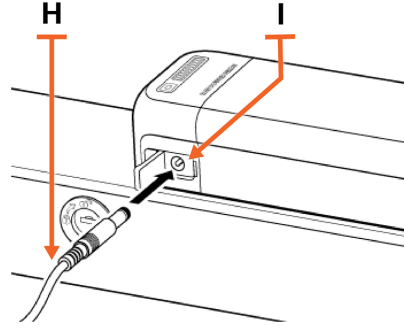

A	Bike frame
B	Keyport for locking and unlocking battery to frame (with key inserted)
C	Battery charging port with rubber cover in place
D	Battery
E	Key
F	Battery button (activates charge-level lights)
G	Charge-level lights
H	Charging plug
I	Battery charging port

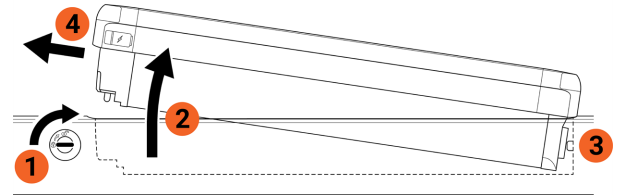

Removing the battery

## REMOVING THE BATTERY

It is possible to remove the battery for storage, transportation, security, or as an option for charging. To remove the battery, follow these steps.

1. Place the key into the keyport and turn it to the unlocked position.
2. The battery lock will release the battery from the frame and lift it out of the mount slightly.
3. Carefully lift the battery up, angling it away from and clearing the terminal contacts ("3" in the illustration above).
4. Pull the battery out of the mount. Be careful not to drop or damage the battery when it's loose from the bike. Do not touch or bend the terminal contacts.

## INSTALLING THE BATTERY

To install the battery, you do not need the key. Check to ensure the battery mount is clean and dry, and then follow these steps.

1. Gently insert the battery into the frame.
2. Align the battery with the terminal contacts.
3. Push down on the battery until you hear a click. Do not force the battery into the battery mount. Ensure the battery is locked in place by gently pulling upward on it.

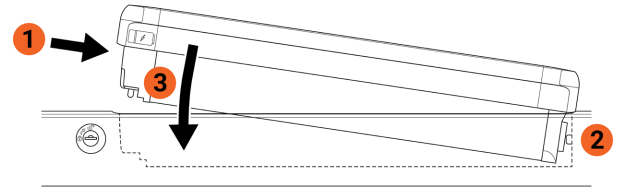

Installing the battery

## CHECK CHARGE LEVEL

Press and release the battery button to illuminate the charge level lights. For information on the battery charge level lights, see [“Rad UI functions and electrical controls” on page 20](#).

## Critical battery safety overview

Also follow these recommendations to ensure safety, and be sure to read all of the critical safety messages in [“You must read and understand all safety-related precautions in this section before handling, using, or storing the battery that came with your RadCity.” on page 17](#).

- **Protect the battery from impact damage.** Do not drop the battery. Ensure the battery is locked to the frame before riding.
- **Protect the battery from water and corrosion damage.** Never submerge the battery in water. Allow rain to run off of the battery from top to bottom as designed. Avoid salt water and de-icing compounds, which are very corrosive and can lead to damage and danger.
- **Remove the key from the bike’s battery keyport before riding.**
- **Never open the battery housing or charger.** There are no user-serviceable parts in either the battery or battery charger.
- **Turn off the bike for maintenance.** Before performing any bike maintenance, bike cleaning, or part replacement, power off the bike and remove the battery to prevent accidental motor activation. Also discharge any remaining power in the electrical system by pressing the power button. That will protect all of the electrical components.

## TEMPERATURES FOR SAFE STORAGE, CHARGING, AND USE

For safety and the best battery performance, please be aware of the following:

- Avoid riding in extreme temperatures, above 113°F (45°C), whenever possible.
- If you ride in extremely hot temperatures (above 113°F (45°C)), use low levels of power assistance (low pedal assist levels, low use of throttle) to keep the battery as cool as possible. This will lower the risk of the battery automatically turning off to prevent use-caused heat damage.
- **Heat can cause the battery to automatically turn off.**
  - When the battery temperature reaches more than 140°F (60°C), the battery is designed to turn off automatically to prevent use-caused heat damage. When the battery cools enough, you should be able to turn your battery back on.
  - Charging your battery when it is warm from riding or from ambient temperatures more than 113°F (45°C) can cause the battery and charger to power off as a safety precaution.
- **Extreme heat can cause permanent battery damage.**
  - Prolonged storage temperatures that exceed 113°F (45°C) can reduce the useful life of the battery.
  - Using your battery so that its temperature reaches 113°F (45°C) or higher may cause permanent damage to the battery in the form of decreased range per charge for the remainder of the battery’s useful life.
  - Storing your battery at temperatures higher than 140°F (60°C) (such as in a hot car in the direct sunlight) may cause permanent range decline or critical failure up to and including an electrical fire.
- **Cold can reduce battery range temporarily.** Riding in temperatures lower than 32°F (0°C) may significantly reduce riding range for that ride. Do not depend on the battery power to perform for the same range available above 32°F (0°C).



- **Extreme cold can cause the battery to automatically turn off.** At -4°F (-20°C) the battery will shut off to prevent damage. Do not depend on battery power to return you back to safety if riding near those extreme temperatures.

### TEMPERATURE RANGE SUMMARY

These are the maximum safe and recommended temperature ranges for your Rad Power Bikes battery. Please see the preceding section for more information.

**Maximum use range:** -4°F to 120°F (-20°C to 49°C)

**Maximum charging range:** 32°F to 113°F (0°C to 45°C)

**Recommended charging range:** 50°F to 77°F (10°C to 25°C)

**Maximum storage range:** -4°F to 140°F (-20°C to 60°C)

## Charging the battery

Here is an overview of how to charge your battery safely. Be sure to also read the safety messages in [“You must read and understand all safety-related precautions in this section before handling, using, or storing the battery that came with your RadCity.” on the next page.](#)

- Always charge your battery with the charger supplied by Rad Power Bikes.
- Check that the battery and charger are undamaged before charging. If the battery or charger look damaged or were involved in a fall or crash (even without outward or obvious signs of damage) contact Rad Power Bikes Product Support for more information.
- Charge your battery in a temperature controlled, dry, safe location ideally at room temperature, 50°F to 77°F (10°C to 25°C). Always charge between 32°F to 113°F (0°C to 45°C), because charging outside of this range may cause permanent damage to the battery in the form of decreased range per charge for the remainder of the battery's useful life.
- Use the charger in a safe place—away from children, direct sunlight, dirt, debris, liquids, tripping hazards (including electrical cords), or any materials that could ignite in the unlikely event of a charger or battery malfunction. Position the charger and battery where they're safe and not at risk for falls or other impacts.
- Your battery and charger generate heat while charging, but they're designed to air-cool. While charging, keep them uncovered on a flat, stable, hard surface. Your charger should face upward with its light visible when in use.
- Store the charger unplugged in a safe place—away from children, direct sunlight, in a place where it could fall, etc. Make sure the charger plugs do not come in contact with liquids, dirt, debris, or metal objects, which can damage the plug and interfere with future operation.

**TIP!** Charge an empty battery as soon as possible. If the battery is completely empty, charge it as soon as possible. Storing a depleted (empty) battery can lead to permanent loss of range or loss of battery life.

**TIP!** Recharge the battery after each ride. Always charge it back to full so it is ready to go the full range per charge next time you want to ride.

### CHARGING PROCEDURE

Anytime you charge your battery, check the battery, charger, and electrical cables for signs of damage. Follow the steps below.

1. **Ensure the bike is off.** Press and hold the power button on the UI Remote until the display turns off. If desired, use the key to unlock and remove the battery from the bike frame. The battery can be charged while it is on or off the bike.
2. **Inspect the battery, charger, and electrical cables for damage.** If everything looks fine, proceed with the rest of the steps. If you find any damage, don't charge your bike. Instead, take photos and seek more information from our Help Center at [www.radpowerbikes.com/help](http://www.radpowerbikes.com/help) or by contacting Rad Power Bikes Product Support.
3. **Plug the charger into the battery's charging port.** Place the charger on a flat, secure surface with the charging status light facing up, open the rubber cover on the battery's charging port, and connect the DC output plug from the charger (round barrel connector) to the charging port on the side of the battery. See [“Rad battery with charging plug” on page 14](#)

4. **Plug the charger into a power outlet.** Connect the charger input plug (110/220-volt plug) to the power outlet. Charging should initiate and will be indicated by the charger status light on the charger turning red.
5. **Unplug the charger from the outlet, then the charging port.** Once fully charged, indicated by the charger status light turning green, disconnect the charger from the outlet then the charger from the battery by pulling directly on the plugs, not the wires themselves.

**NOTICE:** The charger is designed to stop charging automatically when the battery is fully charged. Nevertheless, we recommend you disconnect the battery from the power source and charger as soon as possible once charging is complete. As with any appliance, you should unplug your charger when you're not using it to charge your battery. This will also prevent range decline from unnecessary charging.

## ESTIMATED CHARGING TIMES

The time the charger takes to fully charge the battery depends on factors including distance traveled, riding characteristics, terrain, payload, and battery age. The table provides a rough estimate of charge time based on common distances traveled in regular operation.

**NOTICE:** The battery may take longer to charge when fully depleted, when very new, and after 3–5 years of regular use. If your battery doesn't seem to be charging normally, is taking longer to charge than expected, or you're experiencing substantial reduction in range, discontinue use and contact Rad Power Bikes Product Support.

Distance	Recharge time
5 mi (8 km)	1 hour
10 mi (16 km)	1.5 hours
15 mi (24 km)	2.5 hours
20 mi (32 km)	3.5 hours
25 mi (40 km)	4.5 hours
30 mi (48 km)	5.5 hours
45 mi (72 km)	7 hours

## Long-term battery storage

If storing your RadCity for longer than two weeks at a time, follow the recommendations below to maximize the performance and longevity of your battery.

For peak battery performance over time, store the battery at approximately 40-75% charged (about 4 to 7 charge level lights illuminated). Check the battery's charge level monthly. If necessary, use the charger from Rad Power Bikes to charge the battery to about 40-75% charged.

Storing your battery for long periods at full charge can cause range decline over time.

Do not store your battery at very little or no charge, which can cause permanent range decline or a non-functional battery.

You must read and understand all safety-related precautions in this section before handling, using, or storing the battery that came with your RadCity.

 **DANGER:** Never open the battery housing, which will void the warranty and can result in battery damage. It can also expose you to caustic substances and electrical shock or it could create a fire hazard, which can lead to serious injury or death.

 **WARNING:** Charging your battery with a charger other than one supplied by Rad Power Bikes and designed for your specific bike serial number can cause damage to your bike's electrical system or create a fire hazard. Only use a battery charger designed for your bike and supplied by Rad Power Bikes.

 **WARNING:** Letting the charger's plug contact metal objects could cause a power discharge (a spark), which could injure you or create a fire hazard.

 **WARNING:** Letting a battery charge unattended increases the risk that a charging problem will go undetected and lead to component damage or a fire hazard. Always charge your battery where you can monitor it.

**WARNING:** Using a damaged battery or charger can create additional bike damage or a fire hazard. Stop using your battery and charger and contact Rad Power Bikes immediately if any of the following occur: (1) Your charger's flexible power cord or output cable or any of the electrical cables on your bike is frayed, has broken insulation, or any other signs of damage, (2) Your battery or charger is physically damaged, non-functional, or performing abnormally, (3) Your battery or charger experienced a significant impact from a fall, crash, or shipping damage, with or without obvious signs of damage, or (4) Your charger becomes too hot to touch (it's designed to get warm with normal use), makes an unusual smell, or shows other signs of overheating. Store any damaged battery or charger in a safe location and, as soon as possible, recycle or otherwise dispose of it according to local rules. Contact Rad Power Bikes Product Support if you have any questions or to purchase a compatible replacement battery or charger.

**WARNING:** Using your battery at temperatures higher than 113°F (45°C) may cause permanent damage to the battery in the form of decreased range per charge for the remainder of the battery's life. At temperatures higher than 140°F (60°C), your battery can experience critical failure up to and including an electrical fire. Always store your battery at temperatures lower than 140°F (60°C). If you ride in extreme temperatures (above 113°F (45°C)), use low levels of power assistance (low pedal assist levels, low use of throttle) to keep the battery as cool as possible.

**WARNING:** Never immerse or submerge the battery in water or liquid, including water in the battery mount, which can cause damage, serious injury, or death.

**WARNING:** Using aftermarket battery accessories or products that have not been tested by Rad Power Bikes for safety and compatibility may void your warranty, create an unsafe riding condition, result in bike/property damage, or cause serious injury or death. If you use products not tested and recommended by Rad Power Bikes, you do so at your own risk.

**CAUTION:** To reduce the risk of fire, connect only to a circuit provided with 10 amperes maximum branch circuit over-current protection in accordance with the National Electrical Code, ANSI/NFPA 70.

**CAUTION:** An unlocked or improperly attached battery can fall off a moving bike, causing damage or injury. Always check that the battery is properly attached and locked to the frame before moving or riding your bike.

**NOTICE:** Failure to follow the battery-charging best practices outlined in this chapter could result in unnecessary wear to the charging components, battery, and/or charger, and could lead to an underperforming or non-functional battery. Batteries damaged due to improper care will not be replaced under warranty.

**NOTICE:** When the battery is off its mount, protect the battery terminal contacts from damage and be sure not to touch them. If terminals are damaged, please discontinue use and contact Rad Power Bikes Product Support immediately.

**NOTICE:** Charging your battery in excessively hot conditions or interfering with its ability to air-cool can damage your battery or charger. Always charge your battery at temperatures between 32°F to 113°F (0°C to 45°C), but preferably at room temperature: 50°F to 77°F (10°C to 25°C). Charging your battery at low temperatures may slow charging or prevent a full charge. Keep the battery and charger uncovered, make sure the charger is on a hard, flat, stable surface, and use the charger right-side-up (with charging lights facing upward).

**NOTICE:** The charger is designed to stop charging automatically when the battery is full. Nevertheless, leaving your battery charging longer than necessary can cause needless wear. We recommend you remove the charger from the battery within one hour of the green light indicating a complete charge. Store the charger carefully, making sure its plug does not come in contact with liquids, dirt, debris, or metal objects, which can damage the plug and interfere with future operation.

**NOTICE:** Incorrect storage of your battery can result in a damaged or non-functional battery. Follow the above recommendations to reduce such risk.

**NOTICE:** Always follow any safety information attached to the battery or charger. A sample label for the battery that shipped with your bike is shown at right, some details and manufacturing location may differ.

Model: RAD-XXXXXX XXXXXXXX/XX-X  
RATING: 48V == XXAH XXXWH  
Manufacturer: DLC, MADE IN CHINA  
Patent Pending. Designed in Seattle  
by Rad Power® Bikes

**ATTENTION** ⚠

- The battery pack **MUST** be locked into the frame battery mount before use.
- Ensure the battery and charger are not damaged before charging.
- Don't connect the positive and negative terminal of the battery pack.
- Don't expose the battery to high temperatures.
- Ensure the battery charger is unplugged from the battery pack and put away before you ride.
- Always charge your battery in temperatures between 10 and 25 degrees Celsius (50 and 77 degrees Fahrenheit).
- Do not subject the battery to salt water or leave the bike for extended periods in the rain.
- Only use original equipment for charging.

CE ROHS

Li-Ion

# Operation

**WARNING:** Incorrect assembly, maintenance, or use of your ebike can cause component or performance failure, loss of control, serious injury, or death. Even if you're an experienced bike rider, **you must read and understand the entire manual and any documentation provided for subcomponents or accessories before riding.** If you are not sure you have the experience, skills, and tools to correctly perform all assembly steps in the manual and the assembly video at [www.radpowerbikes.com/assemble](http://www.radpowerbikes.com/assemble), consult a local, certified, reputable bike mechanic.

## How the electrical system works

Your RadCity is equipped with two ways for a rider to use power assistance from the motor to propel the bike forward: a pedal assist system (PAS) and a twist throttle.

### HOW PEDAL ASSIST WORKS

The rider can engage the pedal assist system (PAS) while pedaling, and it will call up assistance from the motor to help propel the bike forward.

Pedal assist uses a cadence sensor built into the drivetrain of the bike. The cadence sensor detects when the rider revolves the pedals and signals the electric motor to provide the level of pedal assistance (0-5)(0-4) that the rider has selected.

### HOW THE THROTTLE WORKS

The throttle is located on the right side of the handlebar. The rider can use it with a twist of the throttle grip to propel the bike forward without pedaling.

To engage the throttle while riding, slowly and carefully rotate it toward yourself. The more you twist, the more powerfully the motor will propel the bike forward. Once you release the throttle or apply the brakes, the throttle will no longer propel the bike forward. Always keep one hand on the brake lever and be prepared to squeeze the lever to disengage the throttle if needed, or turn off the bike to prevent accidentally engaging the throttle.

Some ebikes from Rad Power Bikes are equipped with an on/off switch for the throttle. These switches can be set to "off" even while the bike electrical system is on in order to prevent use of the throttle.

**NOTICE:** Throttle and motor use may not be allowed in all areas. It is your responsibility to know and follow local ebike regulations, rules, and traffic laws where you ride.

## Handlebar features

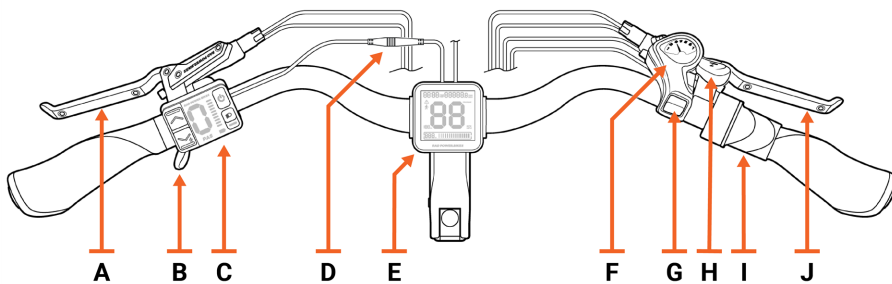

A	Left brake lever (for front brake)
B	Lever for bell
C	Rad UI Remote
D	Display Connector
E	Rad UI Display
F	Shifter
G	Up-shift button
H	Down-shift lever
I	Throttle
J	Right brake lever (for rear brake)

# Rad UI functions and electrical controls

## RAD UI REMOTE

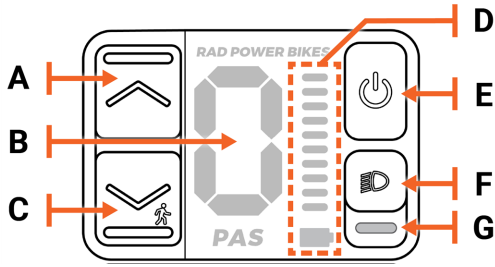

A	Up Arrow
B	PAS (pedal assist system) Level
C	Down Arrow (and Walk Mode)
D	Battery Level (can also display error codes)
E	Power Button
F	Headlight button
G	Headlight-on indicator

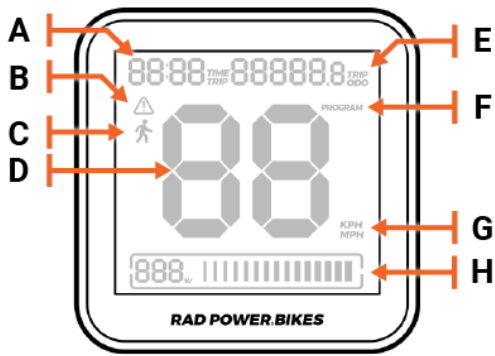

Using the Rad UI Remote (above), the Rad UI Display ([page 20](#)) and other bike features, you can power your bike on or off, view certain information, and control other electrical functions.



## RAD UI DISPLAY

A	Clock or trip timer
B	Error icon
C	Walk-mode icon
D	Speedometer
E	Odometer or trip odometer
F	Program-mode indicator
G	Speedometer units (KPH or MPH)
H	Wattage meter

Power	Power on/power off	Press and release the power button.
	Skip "rAd" sequence at startup	Press and release the Up Arrow or Down Arrow.
	Power save timer	When powered on, the UI will power off automatically after 5 minutes of inactivity.
Lights	Lights at startup	Headlight, taillight, and display backlight will turn on automatically when the bike is powered on.
	Turn on headlight/taillight	When the bike is powered on and the headlight is off, press and release the headlight button.
	Turn off headlight/taillight	While powered on, to turn off the headlight for daytime riding (which is optional), press and release the headlight button.
	Headlight indicator light	This light is located below the headlight button on the Rad UI Remote and will be illuminated when the headlight is on.
	Turn on taillight flash mode	When the bike is powered on, press and release rubber button on bottom of taillight housing. See <a href="#">"Brake light features and operation" on page 23</a> for more information.
	Brake light	See <a href="#">"Brake light features and operation" on page 23</a>
	Adjust display brightness	See <a href="#">"UI Display program settings" on page 22</a> .
Pedal assistance system (PAS)	Increase pedal assist one level	Press and release the Up Arrow on the Rad UI Remote.
	Decrease pedal assist one level	Press and release the Down Arrow on the Rad UI Remote.

Walk mode	Walk mode definition	Walk mode is an option that allows a user to get a small amount of motor assistance to propel the bike forward at 3 mph (6 km/h), while walking beside the bike with both hands on the handlebar. This is helpful for walking up a hill with heavy cargo, for example.
	Turn on walk mode	Press and hold the Down Arrow. After approximately three seconds walk mode will power on and propel the bike forward at 3 mph (6 km/h); walk mode will stay on while the Down Arrow is being held.
	Turn off walk mode	Release the Down Arrow to exit walk mode and end motor assistance, or, as always, squeeze a brake lever to cut off motor assistance.
	How walk mode is displayed on the UI Display	The walk icon (  ) will flash on the left side of the UI Display.
	How walk mode is displayed on the UI Remote	Where the PAS level is normally displayed, two segments will alternate, simulating the motion of foot steps. 

 **CAUTION:** Using walk mode inappropriately can cause you to lose control of the bike, causing bike damage or injury. Use walk mode only while dismounted from the bike, with both hands on the handlebar, and with at least one hand on a brake lever so that you can quickly cut off power to the motor if necessary.

Battery charge level	Battery level indicators on the UI Remote	On the UI Remote, 10 light bars.
	Battery level indicators on the battery	On the battery, 10 light bars (see page <a href="#">“Battery information” on page 14</a> ).
Clock and odometer settings	Odometer/trip odometer definition	The odometer is the total distance the bike has traveled. The trip odometer is the total distance traveled during a ride or rides.
	Clock/trip time definition	The clock shows what time it is. The trip time is the total time elapsed over a ride or rides.
	Toggle between odometer/clock time or trip odometer/trip time	Press and hold the Up Arrow and the Down Arrow at the same time for approximately three seconds to toggle from odometer/clock to trip odometer/trip time.  At first power on, the clock and odometer are the default display settings. The last-selected display setting (either clock/odometer or trip time/trip odometer) will display at power on.
	Reset the trip timer/odometer	When in trip odometer/trip time mode, press and hold the headlight button for approximately five seconds. The trip timer will reset back to 00:00 and the trip odometer will reset to 00000.0.  The trip timer will immediately begin counting once reset and continue counting until the bike is powered off. When the bike is powered on the trip timer will resume counting from the same time when it was powered off.
Other UI Display settings	Wattage meter	Power in Watts the bike is using in real time, displayed as numbers and 15 bars illuminating from left to right as more power is used. (North American bikes only.)
	Speedometer	Current bike speed displayed in either miles per hour (MPH) or kilometers per hour (KPH).

## UI DISPLAY PROGRAMMING

You can use the buttons on the UI Remote to change system settings. Here's how:

1. **Enter programming settings.** Press and hold the Down Arrow and headlight button on the UI Remote at the same time for approximately five seconds, until “P” appears on the UI Remote and “PROGRAM” appears on the UI Display. This will allow you to step through program settings.
2. **Advance through the settings.** Press and release the headlight button to advance through four settings:
  - Select 12 or 24 hour clock,
  - Set clock time,
  - Set units of measurement, and
  - Set screen brightness.

Advancing to the next setting saves the previous program setting.
3. **Exit programming mode.** When you’re done changing settings, exit the programming mode by simultaneously pressing and holding the Down Arrow and the headlight button on the UI Remote for approximately three seconds.

See the chart below for more information on each setting.

UI Display program settings	Select 12 or 24 hour clock	Use Up Arrow or Down Arrow to toggle between 12 hour (12 hr) or 24 hour (24 hr) clock modes.
	Set clock time	Press and release the Up Arrow or Down Arrow to adjust by one minute up or down. Press and hold the Up Arrow or Down Arrow for approximately 2 seconds to adjust by 10 minutes up or down.
	Set units: (miles and mph) or (kilometers and km/h)	Press and release the Up Arrow or Down Arrow to toggle between imperial units (miles & mph) or metric units (kilometers & km/h).
	Set screen brightness	Press and release the Up Arrow or Down Arrow to select a display backlight brightness level between 1 (dim) and 5 (bright).

## Start-up procedure

After the bike has been properly assembled according to the assembly video, all components are secured correctly, a certified, reputable mechanic has checked the assembly, and you have read this entire manual, turn on the bike and select a pedal assist level following the steps below:

1. **Check that the battery is locked securely.** Try tugging on the battery with the key removed; it should not move at all. If it does, push it down gently but firmly and try again until it latches.



**CAUTION:** Getting onto the bike or riding it with the key in the battery can cause injury to your leg and damage to the key or lock mechanism. Always remove the key before riding the bike.

2. **Turn on the bike.** Locate the Rad UI Remote (near the left handlebar grip). Press the power button for about two seconds until the Rad UI Display and the Rad UI Remote turns on (the UI Remote will spell out “rAd”).
3. **Try out your bell** if you haven’t already! It’s an important safety tool for alerting others to your presence, especially when passing. The bell is integrated into the left brake lever on your handlebar. To ring it, flick the bell lever; see the illustration [“Handlebar features” on page 19.](#)



**WARNING:** Engaging the pedal assist feature, especially at a high setting, will cause acceleration that may be greater than expected, especially for relatively new riders, and that can cause loss of control, serious injury, or death. To minimize risk, start at PAS level 0 or 1.

4. **Begin riding carefully.** With the proper safety gear and rider knowledge, you may now operate your bike from Rad Power Bikes. Begin by pedaling on flat ground, clear of obstacles and people, with the bike in an easy (low) gear and at pedal assist level 0 or 1. You may also use the throttle to accelerate and maintain your desired speed.

**NOTICE:** While you’re getting to know your bike, don’t ride with passengers or cargo (see [“Carrying cargo or a child” on page 25](#) for more information). Review, understand, and follow the safety information in [“Ride as safely as possible” on page 35.](#)

5. Use the throttle (next to the right handlebar grip) by slowly and carefully rotating it toward the rider. Do not use the throttle unless you're on the bike, and note that the throttle can be activated with a twist any time the bike is powered on.

**WARNING:** Be careful not to accidentally twist the throttle, which can cause sudden acceleration. If you're not prepared for this acceleration, you can lose control of the bike, which can lead to serious injury or death. To minimize this risk, always keep at least one hand ready to squeeze the brake lever to cut off power to the motor. When you dismount, power off the bike before moving it.

---

## Brake light features and operation

The RadCity is equipped with a taillight/brake light that is integrated into the electrical system. When you turn on your bike, both the headlight and taillight will illuminate to make you more visible to other vehicles. Any time the bike is powered on, squeezing one or both brake levers on the handlebar will activate the brake light, causing the taillight to illuminate additional areas.

The taillight also has a "flash mode" you can activate. To do so, power on the bike, and then, while dismounted from the bike, press the rubber flash-mode button on the bottom left side of the taillight housing. When in flash mode, the taillight will flash continuously, and squeezing the brake lever(s) will illuminate a brighter, solid brake light. Flash mode will continue if the headlight is turned off. But if you turn the bike off and back on, you'll need to re-activate flash mode.

**NOTICE:** Flashing lights may not be legal in some areas. It is your responsibility to know and obey all applicable laws where you ride your ebike.

---

## Driving range

We suggest that you select a lower pedal assistance level when you're getting to know your RadCity and travel routes. Once you become familiar with your range requirements and the capabilities of your bike, you can adjust your riding characteristics if you desire.

The table in this section provides range estimates under example conditions to help owners understand the factors that can increase or decrease range. Rad Power Bikes makes no claims about the range that individual users might experience in a particular situation.

25 mi (40 km):	<ul style="list-style-type: none"><li>• Hilly terrain</li><li>• Windy</li></ul>	<ul style="list-style-type: none"><li>• Light pedaling</li><li>• Heavy payload</li></ul>	<ul style="list-style-type: none"><li>• High pedal assist level, high throttle use</li></ul>
35 mi (56 km):	<ul style="list-style-type: none"><li>• Flat terrain</li><li>• Not windy</li></ul>	<ul style="list-style-type: none"><li>• Light pedaling</li><li>• Normal payload</li></ul>	<ul style="list-style-type: none"><li>• Low pedal assist level, minimal throttle use</li></ul>
45 mi (72 km):	<ul style="list-style-type: none"><li>• Flat terrain</li><li>• Not windy</li></ul>	<ul style="list-style-type: none"><li>• Moderate to heavy pedaling</li><li>• Normal payload</li></ul>	<ul style="list-style-type: none"><li>• Low pedal assist level, minimal throttle use</li></ul>

---

## Best practices for extending range and battery life

Follow the best practices listed below to help extend your range and battery life.

- Whenever possible, avoid applying full throttle when the bike has slowed to very low speeds, has stalled, or stopped.
- Pedal to assist the motor when climbing hills and accelerating from a stop.
- Reduce your power consumption whenever possible.
- Do not climb hills steeper than 15% in grade.
- Avoid sudden starts and stops.
- Accelerate slowly.



---

## Parking, storage, and transport

Please follow these tips to ensure your bike is well cared for when you're not using it.

### PARKING AND STORAGE

- Park in accordance with local rules and regulations, especially if you're in a public place.
- Park indoors whenever possible. If you must park outdoors in rain or wet conditions, do not do so for an extended period of time, and afterward park in a dry location to allow the bike systems to dry out. When any bike is exposed to wet conditions, it will need a more frequent maintenance schedule to prevent rust and corrosion and to ensure all systems work safely. See [“Guard against rust, corrosion, and water damage” on page 32](#) for more information.
- Avoid parking or storing your bike in direct sunlight, which can cause damage to the display.
- Do not park or store your bike in excessive heat, such as inside of a parked car on a hot day. Always store your bike within this temperature range: -4°F to 140°F (-20°C to 60°C).
- Switch the power and any lights off to conserve battery power. Remove the key from the bike and ensure the battery is locked to the frame or use the key to remove the battery and bring it with you for security.
- Register your bike with [BikeIndex](#), [529 Garage](#), or a regional bike registry (ask your local bike shop for recommendations) to increase the chance you'll get your bike back in the unfortunate event it's stolen.
- Lock up your bike to reduce risk of theft. You can purchase a lock from our website at [www.radpowerbikes.com](http://www.radpowerbikes.com) or consult a local, certified, and reputable bike shop.

### TRANSPORTING

- When pushing or carrying the bike, turn off the power to avoid accidental acceleration from the motor, e.g. by mistakenly twisting the throttle. Another option is to keep the bike powered on and use “walk mode”—see [“Rad UI functions and electrical controls” on page 20](#) for more information.
- Only use racks (i.e., a bike rack for your car or other vehicle) designed for the size and weight of your ebike. Pay particular attention to whether the rack can accommodate the width of your ebike tires. Racks are available for purchase at [www.radpowerbikes.com](http://www.radpowerbikes.com).
- When carrying your ebike on a rack for transport, remove the battery, and place/wrap it securely inside your vehicle, making sure it can't roll around and that its plugs and contacts are protected. This will reduce the weight of the bike, make lifting and loading it easier, and keeps your battery safer.
- Do not leave a battery in direct sunlight or any location that is or may become excessively hot or cold, like a parked car, for extended periods.
- Before using public transportation (buses, trains, etc.) to transport your ebike, check with the relevant transportation authority for any rules that might pertain to ebikes, including rules governing weight limits, tire widths, lithium-ion batteries, etc.
- Avoid transporting bike(s) from Rad Power Bikes on a vehicle rack during rain, which may cause water damage to the electrical components. See [“Guard against rust, corrosion, and water damage” on page 32](#) for more information.

# Carrying cargo or a child

Carrying cargo or a child can help you have more fun on your ebike and replace trips you'd otherwise make with a car, which we think is rad. It also involves additional risks, which require special attention and care. You must read and understand this entire chapter and the rest of the manual plus any documentation that comes with any accessories you purchase before you ride your ebike with cargo and/or any passenger.

Rad Power Bikes provides a wide range of accessories to make it easier to carry cargo. Your RadCity is designed to carry a single small child in the optional Thule Yepp Maxi child seat attached to its rear rack. See [“Carrying passengers” on the next page](#) for more information.

For more information on optional accessories for your ebike, please go to [www.radpowerbikes.com](http://www.radpowerbikes.com).

**NOTICE:** Carrying a passenger, child, or cargo may not be allowed in all areas. It is your responsibility to know and follow all applicable laws where you ride your ebike.

---

## Weight limits

The total maximum weight limit (payload capacity) of your ebike, listed below, includes the weight of the rider as well as clothing, riding gear, cargo, accessories, passengers, etc. See [“Carrying passengers” on the next page](#) for more safety information about passengers.

**Total maximum payload of the RadCity:** 275 lb (125 kg)

**Rear rack maximum payload:** 60 lb (27 kg)

The maximum payload capacity and other important safety information for specific Rad Power Bikes accessories will come with those products and/or be available online at [www.radpowerbikes.com/help](http://www.radpowerbikes.com/help).

 **WARNING:** Never exceed the payload limit of any accessory or component of your bike even if you attach to it an accessory that carries a higher weight limit. Overloading any component can cause component failure, loss of control, serious injury, or death.

---

## Carrying loads (cargo or passengers) safely

Follow these recommendations to maximize safety when using your RadCity to carry cargo or passengers.

- Carrying extra weight significantly affects braking, acceleration, turning, balancing, etc. These effects can be increased by challenging riding conditions, such as when roads are wet or slick. Hills that are normally easy to climb or descend without cargo can become challenging or even dangerous once extra weight is loaded onto the bike. Extra weight will increase the time it takes to slow the bike when braking.
- Practice riding with light cargo in a flat, open area that's free of obstacles before attempting to ride with heavier loads, and/or in wet or hilly conditions.
- With extra weight on your bike, it's more important than ever to use both front and rear brakes, and always engage the rear brake first to prevent excessive strain on the front wheel and fork and to prevent loss of control. Ensure both front and rear brakes are properly adjusted, maintained, and applied.
- Load cargo as low as possible to keep the bike's center of gravity low and improve stability.
- Hold onto the bike when loading and carrying cargo and/or passengers. The kickstand is not designed to be used for loading cargo or passengers. Do not assume the bike is stable and balanced when using the kickstand.
- Ensure cargo loads are properly secured and periodically check that nothing loosens, risks interfering with any moving parts, or risks touching or dragging on the ground.
- When carrying heavy loads or passengers, plan your routes to avoid challenging hills and other hazards.
- It is always the rider's responsibility to ensure cargo or a passenger loaded on the ebike will not interfere with the rider's ability to safely operate the ebike.

 **WARNING:** Failure to ensure that cargo or passengers can't interfere with the rider's control of the bike can lead to serious injury or death. The rider is always responsible for securing loads, loose straps, and assessing passenger's ability to ride safely. Please see ["Carrying passengers" below](#) for more information.

 **WARNING:** Carrying cargo or passengers significantly affects braking, acceleration, turning, and balancing, which can increase the risk of falls and other accidents, potentially leading to property damage, serious injury, or death. To minimize such risk, practice riding with light cargo in a flat, open area before attempting to carry heavier cargo or passengers, especially on roads or hills and in wet conditions.

 **WARNING:** Loading cargo or passengers without holding onto the RadCity can cause the bike to tip, leading to damage or serious injury. The kickstand is designed to hold up an unoccupied, unloaded bike on a hard, flat, stable surface, not to support the weight of the rider, passengers, or cargo. Always hold onto your RadCity when loading or unloading cargo or passengers.

 **WARNING:** Using the front brake by itself can cause excessive stress on components, damage to the bike and parts, loss of control, injury, or death. Always apply the rear brake before applying the front brake, using both brakes for all operations.

---

## Carrying passengers

Your RadCity is designed to carry one small child in a Thule Yepp Maxi child seat. The Thule Yepp seat must be attached to the built-in rear rack.

 **DANGER:** Using your RadCity to transport a passenger who is not the appropriate size or age for your child seat, or who does not have the health, motor control, or impulse control to ride safely as a passenger, can lead to serious injury or death of the rider or passenger. Read and understand the specifications of any child seat you purchase and all safety-, cargo-, and passenger-related information in this manual. It is your responsibility to assess the ability of a potential passenger to ride safely. If you're not certain, consult a physician.

 **DANGER:** Leaving a child unattended on a bicycle creates a VERY HIGH RISK of the bike tipping over, causing serious injury or death. Always remove your child from the bike before you look away or walk away from the bike.

 **WARNING:** To reduce the risk of injury, always closely supervise children if and when you use your RadCity near them.

 **WARNING:** Serious injury or death can occur if clothing or body parts contact either wheel or other moving parts while the bike is in motion.

### USING A CHILD SEAT FOR SMALL CHILDREN

Your RadCity is designed to work with the Thule Yepp Maxi child seat, which can attach to the "Yepp window" on your RadCity's built-in rear rack.

The Thule Yepp Maxi child seat can be purchased from Rad Power Bikes at [www.radpowerbikes.com](http://www.radpowerbikes.com).

For installation instructions, safety notices, age/weight requirements, general information, and tips on safe operation of the Thule Yepp Maxi child seat accessory, visit the manufacturer's website online at [www.thule.com](http://www.thule.com) or visit the Rad Power Bikes Help Center at [www.radpowerbikes.com/help](http://www.radpowerbikes.com/help).

---

## Carrying pets

Rad Power Bikes understands that you may want to bring your pet along on your bike adventures, and we think that's rad. We urge you to take great care to protect your furry friend and yourself. To check out the pet accessories that we have tested for safety and compatibility with our ebikes, please visit [www.radpowerbikes.com](http://www.radpowerbikes.com). We cannot recommend any pet carrier or restraint system that we have not tested for compatibility and safety with your ebike from Rad Power Bikes.

 **WARNING:** Transporting a pet using any bike puts you and your pet at risk of injury or death, especially if the pet distracts you, affects your balance, interferes with moving bike parts, etc. It's impossible to anticipate every situation that can occur while riding with a pet. If you carry a pet on any bike, you assume any and all inherent risks.

# Maintenance

Follow these maintenance guidelines to ensure your RadCity is safe and fun to ride.

---

## Check and service your bike regularly

On any bike, certain parts need to be replaced periodically due to wear, and sometimes parts become damaged for various reasons. Check your bike before each ride by following the directions in [“Safety checklists” below](#). Have your bike regularly serviced by a certified, reputable bike mechanic. See [“Recommended service intervals” on page 29](#) for more information.

Components of any ebike are subject to higher wear compared to the components of bikes without power assistance. This is because ebikes can travel at higher average speeds than regular bicycles and generally weigh more. Higher wear is not a defect in the product and is not subject to warranty. Typical components affected are the tires, brake pads and rotors, suspension forks, spokes, wheels, and the battery.

If you need to replace a part on your bike, visit [www.radpowerbikes.com](http://www.radpowerbikes.com). If you want something that isn't listed there, contact Rad Power Bikes Product Support. Be extremely careful about using parts or accessories that Rad Power Bikes has not tested for safety and compatibility with your specific bike model.

 **WARNING:** Using aftermarket accessories or components (trailers, stands, vehicle racks, etc.) that have not been tested by Rad Power Bikes for safety and compatibility with your specific bike may void your warranty, create an unsafe riding condition, result in bike/property damage, or cause serious injury or death. If you use replacement parts or accessories not tested and recommended by Rad Power Bikes, you do so at your own risk.

---

## Safety checklists

### BEFORE YOUR FIRST RIDE

- Make sure handlebar cables were routed correctly when the handlebar was installed. Turn the handlebar fully to the left and right and make sure this doesn't pull any of the cables or wires taut.
- Make sure your pedals are secure using a pedal wrench. Torque to 35 Nm.
- Check that the cable connectors on the bike are all plugged in securely and that nothing loosened in shipping.
- Check the brake functions per the directions in [“Checking brakes & motor cutoff switches” on page 30](#) but note that brakes can rub a little the first few times you ride. This is okay and normal; any squeak or noise should go away with use.
- Check everything on the “Before every ride” list below.

### BEFORE EVERY RIDE

Before every ride or every 25–45 miles (40–72 km), follow the safety checklist in the table below. If you find anything amiss with your bike, don't ride it until you're sure it's fixed. Consult a local, certified, and reputable bike mechanic or explore our Help Center at [www.radpowerbikes.com/help](http://www.radpowerbikes.com/help) if you have any questions.

#### Fasteners

- Ensure all fasteners are correctly tightened according to the specifications in [“Tools and recommended torque values” on page 8](#).
- Check that all quick-release levers, including the quick release on the front wheel and the seatpost, are tight and properly secured. Ensure the front wheel quick-release lever is positioned so that the front fork lower doesn't prevent it from closing fully.
- Check that the fasteners on any accessories you've added are properly tightened according to the manufacturer's instructions.

#### Brake system

- Check brake pads and ensure the brake pad material isn't thinner than the backing plate it attaches to.
- Ensure brake pads are correctly positioned in relation to the brake rotors.
- Ensure brake housing shows no obvious wear.

- Ensure brake levers are properly positioned and tightly secured to the handlebar.
- Ensure the brake lever tension is appropriate.
- Check that the taillight brightens when you squeeze each brake lever.
- Use the techniques in [“Checking brakes & motor cutoff switches” on page 30](#) to test the brake levers, brakes, and motor cutoff switches.

### Wheels & tires

- Ensure tires are holding air and inflated to within the PSI limits displayed on the tire sidewalls.
- Ensure tires have good tread, have no bulges or excessive wear, and are free from any other damage.
- Ensure rims run true and have no obvious wobbles, dents, or kinks. See [“Tire and wheel care” on page 31](#).
- Check each wheel spoke. If any are loose or broken, seek help from a certified, reputable mechanic.
- Check the axle nuts on the rear wheel to ensure they are correctly tightened (see [“Tools and recommended torque values” on page 8](#)).
- Check the security of the front-wheel quick release and the rear wheel mounting hardware. The wheel security and hardware torque should also be checked on a regular basis (see [“Tools and recommended torque values” on page 8](#)). Either wheel can become loose or unsecured with normal use.



**WARNING:** An improperly secured front or rear wheel can cause loss of control, accidents, serious injury, or death. Check that both wheels are properly secured during assembly and before each ride.

### Steering

- Ensure the handlebar and stem are correctly aligned, adjusted, and tightened for proper steering.
- Perform a handlebar twist test to ensure the stem clamp bolts are secure. See [“Handlebar twist test” on page 32](#).
- Ensure the handlebar is set correctly in relation to the fork and the direction of travel.
- Ensure the handlebar grips are secure and undamaged.

### Bearings

- Check that headset, wheel, pedal, and bottom-bracket bearings are lubricated, run freely, and display no excess movement, grinding, or rattling.

### Drivetrain: cranks, pedals, chain, derailleur, shifter

- Ensure pedals are securely tightened to the cranks. See [“Tools and recommended torque values” on page 8](#).
- Ensure the cranks are not bent and are securely tightened to the bottom bracket. See [“Tools and recommended torque values” on page 8](#).
- Ensure the chain is clean, lubricated, and runs smoothly. Take extra care with chain maintenance if the bike is used in wet, salty, dusty, or otherwise damaging conditions.
- Check that the derailleur is adjusted and functioning properly.
- Ensure the shifter is attached to the handlebar securely and is shifting properly.

### Frame, fork, and seat

- Check that the frame and fork are not bent or broken.
- Check that the seat is adjusted properly, the seatpost quick-release lever is securely tightened, and the seat does not move when the lever is closed. Ensure that the seatpost minimum insertion marking is fully inserted into the frame.

### Motor drive assembly & throttle

- Ensure the hub motor is spinning smoothly and is in good working order.
- Ensure the power cable running to the hub motor is secured and undamaged.
- Check the axle nuts to ensure they are correctly tightened (see [“Tools and recommended torque values” on page 8](#)).
- Ensure the torque washers, torque arm, and torque arm bolt are in place and secured.
- Ensure the throttle and pedal assistance are operating normally.

### Battery

- Ensure the battery is charged.
- Ensure there is no damage to the battery.
- Ensure the battery is locked to the frame and is secured. Remove the key before riding.
- Ensure the battery gauge on the Rad UI Display and the charge status indicator on the battery read similarly.

## Cables

- Look over electrical cable connectors to make sure they are fully seated and free from debris or moisture.
- Check cables and cable housing for obvious signs of damage.
- Ensure cables are secured away from moving parts.
- Ensure headlight, taillight, and brake light are functioning, adjusted properly, and unobstructed.

## Accessories & safety gear

- Ensure all reflectors are properly fitted and not obscured.
- Ensure all accessories and components installed on the bike are properly secured and functioning according to their manufacturer's specifications.
- Check all safety gear, clothing, cargo, and accessories for loose or potentially loose straps/elements and secure them.
- Ensure rider and any passengers are wearing a helmet and other required riding safety gear, and inspect these items for signs of damage.
- If your bike has fenders: Ensure they are centered over the wheels, adjusted properly, properly secured (see [“Tools and recommended torque values” on page 8](#)), and have no cracks or holes.



**WARNING:** Riding your bike when any component's useful life is surpassed can cause that component to fail, resulting in loss of control, serious injury, or death. Pay attention to signs of wear such as cracks, scratches, component color change, and operational changes that could indicate a component needs replacing. Before each ride, check your bike using the [“Safety checklists” on page 27](#). Perform regular maintenance according to [“Recommended service intervals” below](#). If you're not sure you have the experience, skills, and tools to perform safety checks and regular maintenance, consult a local certified, reputable bike mechanic for help.

## AFTER EVERY RIDE

- Store your bike and battery in a dry location and take other sensible precautions as described in [“Parking, storage, and transport” on page 24](#).
- Guard against damage from the elements by following the recommendations in [“Guard against rust, corrosion, and water damage” on page 32](#).
- Charge your battery in a temperature-controlled location and follow the recommendations in [“Battery information” on page 14](#).

---

## Recommended service intervals

Regular maintenance of any bike is key to ensuring the best possible performance and reducing wear and tear on systems. Ideal service intervals vary depending on use conditions. We generally recommend inspections, service, and necessary replacements be performed at the time and distance intervals described below, but you should have your bike serviced more frequently if you ride aggressively, with heavy payloads, or in harsh conditions. Have your bike inspected immediately if you notice problems or your bike has been involved in a fall or other accident.



**WARNING:** Have your bike inspected by a certified, reputable bike mechanic after any fall, crash, or accident, as these can cause damage (visible or internal/not readily apparent), make your bike unsafe, and lead to serious injury or death. Be particularly cautious about using a battery that has experienced a significant impact from a fall or crash; a damaged battery may not show external signs of damage. Using a damaged battery or charger can create additional bike damage or a fire hazard. For more information, see [“Battery information” on page 14](#).

## AFTER BREAK-IN PERIOD OF 50–100 MILES (80–160 KM)

- |         |  |
|---------|--|
| Inspect | <input type="checkbox"/> Check all cables and the chain for stretch.   |
|         | <input type="checkbox"/> Check spoke tension and the trueness of the wheels.   |
|         | <input type="checkbox"/> Check all bolted connections for loosening and ensure they are tightened to recommended torque values (see <a href="#">“Tools and recommended torque values” on page 8</a> ). |
| Service | <input type="checkbox"/> Have a certified, reputable bike mechanic perform a thorough tune-up.   |



**WARNING:** Certain components can stretch or loosen during any bike's break-in period, which can lead to component failure and potential injury or death. Be sure to have a certified, reputable bike mechanic perform a thorough tune-up after this break-in period or sooner if you notice any problems or if you ride aggressively, with heavy payloads, or in harsh conditions.

### WEEKLY, 100–200 MILES (160–320 KM)

- Inspect**
  - Check hardware for proper torque—see [“Tools and recommended torque values” on page 8](#).
  - Check drivetrain for proper alignment and function (including chain, freewheel, chainring, and derailleur).
  - Check wheel trueness and spoke tension, and check for quiet wheel operation (without spoke noise).
  - Check frame for any damage.
- Service**
  - Clean frame by wiping frame down with damp cloth.
  - Clean and grease the chain.
- Replace**
  - Replace any components confirmed to be broken or damaged beyond repair by Rad Power Bikes Product Support or a certified, reputable bike mechanic.

### MONTHLY, 250–750 MILES (400–1200 KM)

- Inspect**
  - Check brake pad wear, alignment, and the brake lever tension.
  - Check for proper shifting and proper derailleur cable tension.
  - Check chain stretch.
  - Check shifter cables for corrosion and fraying.
  - Check wheel trueness and spoke tension, and check for quiet wheel operation (without spoke noise).
- Service**
  - Clean and lubricate drivetrain.
  - Check crankset and pedal torque.
  - Clean shifter cables.
  - Tension spokes and true wheels if any loose spokes are found.
- Replace**
  - Replace shifter cables if necessary.
  - Replace brake pads if necessary (typically when the pad material is thinner than the backing plate).

### EVERY 6 MONTHS, 750–1250 MILES (1200–2000 KM)

- Inspect**
  - Inspect drivetrain (chain, chainring, freewheel, and derailleur).
  - Inspect all cables and housings.
- Service**
  - Standard tune-up by certified, reputable bike mechanic.
  - Grease bottom bracket.
- Replace**
  - Replace brake pads.
  - Replace tires if necessary.
  - Replace cables and housings if necessary.

---

## Checking brakes & motor cutoff switches

All vehicles, including your RadCity, need reliable brakes. Test your brake levers, brakes, and motor cutoff switches for proper functioning before every ride. If anything seems wrong, take your bike to a local, certified, and reputable bike mechanic, refer to our Help Center ([www.radpowerbikes.com/help](http://www.radpowerbikes.com/help)), or contact Rad Power Bikes Product Support.

 **WARNING:** Touching the brake rotor, which has sharp edges and can get very hot while you're riding, can cause serious injury, slicing damage, or burns. The brake rotor heats up from normal friction when the brake pads press against the brake rotor to slow or stop the bike. Touching the brake rotor with bare skin can also transfer natural oils to the rotor, which can decrease braking performance. **Do not touch the brake rotor, especially when it's in motion or after you've been riding your bike.** Touch the brake rotor only for necessary maintenance when it is cool, not moving, and while you are wearing gloves or using other appropriate protective equipment.



1. **Test the brake levers.**
  - a. Fully squeeze each lever, and ensure neither the front nor rear brake lever touches the handlebar grips.
  - b. Ensure both brake levers are properly lubricated. If they are, they'll be reasonably easy to squeeze without feeling as though there's grit in the mechanism. When you release them, they will immediately go back to their original position.
  - c. Make sure each lever is properly oriented and firmly secured to the handlebar.
2. **Test each brake.**
  - a. Squeeze the left brake lever to lock the front brake, and then try to push the bike forward using the handlebar. The front wheel should not spin.
  - b. Squeeze the right brake lever to lock the rear brake. Again, push against the handlebar to try moving the bike forward. The rear wheel should not spin.
3. **Test the motor cutoff switches.** The front and rear brake levers contain motor cutoff switches, which cut off power from the motor whenever the brakes are applied.
  - a. In a clear, open area, turn on the bike. With appropriate safety gear and clothing, sit on the bike.
  - b. Squeeze the left brake lever to engage the front brake.
  - c. Lightly apply the throttle. The bike should not move since the brake is applied.
  - d. Release the throttle.
  - e. Release the brake.
  - f. Test that the throttle now operates with the brake not engaged.
  - g. Release the throttle.
  - h. Perform steps "a"–"g" again, this time with the rear brake lever (on the right side of the handlebar).

---

## Tire and wheel care

The tires and inner tubes that came with your ebike are designed for durability and safety for regular cycling activities. Wheels and tires need to be checked before each use to make sure they're in good condition. Always replace tires and inner tubes that have punctures, cuts, bulges, damage, or excessive wear before you ride.

### TIRE INFLATION

Inflate tubes and tires to within the PSI range stamped onto the tire sidewall. For additional information about tire pressure, please consult our Help Center at [www.radpowerbikes.com/help](http://www.radpowerbikes.com/help).

 **WARNING:** Underinflating your tires can result in loss of control. Overinflating can make tires burst. Either scenario can lead to serious injury or death. Always maintain the correct air pressure of your tires, which is listed on the tire's sidewall, and use a regulated air source with pressure gauge so that you can measure pressure accurately.

### WHEEL "TRUENESS"

Your wheels should always spin straight ("true") and must be repaired or replaced if they wobble side to side or up and down when spinning. To test them, do this:

1. Spin the wheel.
2. Brace a dull pencil against the frame or fork, with the tip just touching the rim.

If the gap between the spinning rim and pencil changes more than 5 mm, your wheels may need truing. If your wheels become untrue or if spokes loosen, which can happen with normal use, we recommend that you have a certified, reputable bike mech-



anic perform wheel tuning and truing operations. Do not attempt to true wheels or tighten spokes unless you have the highly specialized skills and tools to do so.

## TIRE REPLACEMENT

Even tires equipped with built-in flat-preventative tire liners, like those that come with your RadCity, can and do get flats from punctures, pinches, impacts, and other causes. If you get a flat tire or see evidence of tire wear, you must replace your tire and/or tubes before operating the bike again. Otherwise, you risk bike/property damage, serious injury, or death.

 **CAUTION:** Removing a tube from your wheel rim before the air has been released from it can cause the tube to burst, potentially causing serious injury. Always release air pressure before removing your tube.

 **WARNING:** Aftermarket tires or inner tubes not provided by Rad Power Bikes may not be compatible with your wheels or the performance requirements of your ebike. Such tires can fail or create unsafe riding conditions, causing serious injury or death. Always use replacement tires and tubes that are sized to be compatible with your bike frame. For safety, and if required by law, ensure replacement tires have sufficient reflective sidewall striping.

For more information on tire or tube replacement, visit [www.radpowerbikes.com/help](http://www.radpowerbikes.com/help) or contact Rad Power Bikes Product Support.

---

## Handlebar twist test

 **WARNING:** An improperly secured wheel and/or handlebar stem can cause loss of control, accidents, serious injury, or death. Check that the front wheel and handlebar stem are properly secured during assembly and before each ride.

1. **Brace the front wheel.** Stand at the front of the bike, facing the handlebar, and brace the front wheel between your feet and lower legs.
2. **Try to twist the handlebar.** Hold both handlebar grips and push forward with one hand while pulling back with the other. Push and pull at the same time with about 20 lb of force with each hand.
3. **Ensure the handlebar and wheel stay properly aligned.** The handlebar and handlebar stem should be tightly secured, and the handlebar should be perpendicular to the front wheel.
4. **Repeat the twist test pulling/pushing with the opposite hands,** using about 20 lb of force pushing with one hand and 20 lb of force pulling with the other hand.
5. **If needed, align the handlebar and stem and torque the stem clamp bolts evenly.** Instructions for doing so are in [“Assembly instructions for the RadCity” on page 2](#). Be sure to torque the stem clamp bolts evenly to the specification listed in [“Tools and recommended torque values” on page 8](#). After torquing the stem clamp bolts to the proper specification, perform the twist test again. If the handlebar still moves, contact Rad Power Bikes Product Support.

 **WARNING:** If you are not sure you have the experience, skills, and tools to correctly perform all steps to secure and verify the security of the handlebar, front wheel, and handlebar stem you **MUST** consult a certified, reputable bike mechanic to check your work and/or secure those components to the bike properly.

---

## Guard against rust, corrosion, and water damage

 **WARNING:** Damage to your ebike’s electrical system caused in any manner, including water intrusion, can lead to battery failure, electrical system malfunction, or electrical fire and consequent property damage, injury, or death. Follow all recommendations to minimize chance of water damage. If you have any questions, contact Rad Power Bikes Product Support.

Like any vehicle used outdoors, your RadCity needs care to ensure it isn’t damaged by the elements. Follow these steps for a long, healthy life for your ebike:

- Store under shelter and in an upright position; avoid leaving the bike in the rain or exposed to corrosive substances such as water, salt, or de-icing substances. If exposed to rain, dry your bike afterward, and apply an anti-rust treatment to the chain and other unpainted steel surfaces.

- To clean your ebike, turn the bike and battery off and wipe the frame with a clean, damp cloth. If needed, apply a mild, non-corrosive detergent mixture to the damp cloth and wipe the frame. Dry by wiping with a clean, dry cloth. Never use high-pressure water on your bike. Wipe down your bike frequently and wipe or spray all unpainted mechanical parts with anti-rust treatment.
- If painted metal parts become scratched or chipped, use touch up paint or nail polish to prevent rust.
- Never immerse or submerge the bike or any components in water or liquid, which can damage the electrical system.
- Avoid riding on the beach, in coastal areas with high-salinity fog, or on surfaces treated with salt or de-icing compounds. Doing so exposes your bike to salt or other substances that are very corrosive. Corrosion of electrical components can lead to permanent damage that can cause battery failure, electrical system failure, or electrical fire. Damage from corrosion is not covered under warranty.

## Troubleshooting

Problem	Most common solutions
<b>Bike doesn't work:</b>	
Insufficient battery power	Charge the battery
Battery is in ship mode	End ship mode by pressing and holding the battery button for at least three seconds (feature available on some models)
Battery not fully seated in tray	Install battery correctly
Faulty connections	Clean and reconnect connectors
Improper turn-on sequence	Turn on bike with proper sequence
Brakes are squeezed	Disengage brakes
Walk mode stopped	Ensure nothing is keeping any button(s) other than the walk mode button pressed on the UI Remote (on some models)
UI button(s) held	Ensure nothing is keeping any button(s) pressed on the UI Remote (on some models)
Battery non-functional	Replace battery
<b>Throttle stops working:</b>	
Error 22 (communications error) with or without error code displayed	Consult our Help Center at <a href="http://www.radpowerbikes.com/help">www.radpowerbikes.com/help</a> .
<b>Irregular acceleration and/or reduced top speed:</b>	
Insufficient battery power	Charge or replace battery
Loose or damaged throttle	Replace throttle
<b>When powered on, the motor does not respond:</b>	
Loose wiring	Reconnect or replace
Loose or damaged throttle	Tighten or replace
Loose or damaged motor plug wire	Reconnect or replace
Damaged motor	Replace

### Reduced range:

Low tire pressure	Inflate tires to PSI stamped on sidewall
Low battery	Charge battery
Driving with too many hills, headwind, braking, or excessive load	Assist with pedals or adjust route
Battery discharged for long period without regular charges	Recharge the battery. If range decline persists, consult our Help Center at <a href="http://www.radpowerbikes.com/help">www.radpowerbikes.com/help</a> .
Brakes rubbing	Adjust the brakes
Faulty, damaged, or aged battery	Contact Rad Power Bikes Product Support to replace battery. Disconnect and store damaged battery in a safe location and recycle or dispose of as soon as possible according to local rules.

### The battery won't charge:

Charger not well connected	Adjust the connections
Charger damaged	Replace the charger
Battery damaged	Disconnect and store battery in a safe location and recycle or dispose of as soon as possible according to local rules. Contact Rad Power Bikes Product Support to replace battery.
Wiring damaged	Replace
Battery non-functional	Replace battery

### Wheel or motor makes strange noises:

Loose motor cable connection	Reconnect cable
Damaged wheel spokes or rim	Repair or replace
Damaged motor wiring	Replace motor

## Error detection

Your RadCity is equipped with an error detection system integrated into the Rad UI and motor controller. In the case of an electronic control system fault, an error code should appear on the Rad UI Display and the Rad UI Remote. If your bike has an error code displayed at any time, we recommend that you cease operation and look up the error code troubleshooting information at [www.radpowerbikes.com/help](http://www.radpowerbikes.com/help). Contact Rad Power Bikes Product Support if you have questions. Here's how an error code will display:

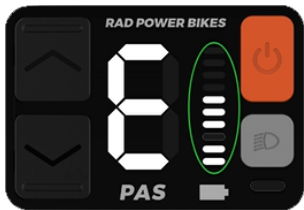

Rad UI Remote

The Rad UI Remote displays error codes via a large "E" and lighted bars (circled in green here). In this example, the lower two bars represent the first digit, "2," in "23," and the top three bars represent the second digit, "3," in "23." The Rad UI Display shows the error number explicitly.



Rad UI Display

The following error codes are the most common and can aid in troubleshooting.

Your RadCity is equipped with an error detection system integrated into the Rad UI Remote and motor controller (see ["Rad UI functions and electrical controls" on page 20](#) for more information). In the case of an electronic control system fault, an error code should appear on your UI Remote, in the form of an "E" with a combination of dashes that will tell you which error you have (see the illustrations below).

Error	Definition
21	Abnormal current
22	Throttle fault
23	Motor phase fault
24	Motor hall fault
25	Brake switch fault or the brake applied while turning on
30	Communication fault
31	Power button hold fault
34	Walk mode disengage fault

If an error code displays, make note of the number or take a picture. Try turning the bike off and then back on. If the error persists, turn off the bike and then stop touching it to ensure you aren't causing the error by accidentally pressing a button, etc. Go to our Help Center ([www.radpowerbikes.com/help](http://www.radpowerbikes.com/help)) to look up information on the error code or contact Rad Power Bikes Product Support.

These error codes are the most common and can aid in troubleshooting. If your bike has an error code displayed at any time, we recommend that you cease operation, take a picture of the error code for reference, and then look up the error code troubleshooting information at [www.radpowerbikes.com/help](http://www.radpowerbikes.com/help). Contact Rad Power Bikes Product Support if you have questions.

## Ride as safely as possible

Ride Rad by taking the sensible measures outlined in this section to maximize your safety. Bicycling is an exciting, delightful, and practical way to get around, but like any sport, it involves risk of injury and death. By choosing to ride a bike, you assume responsibility for those risks.



**WARNING:** Incorrect assembly, maintenance, or use of your ebike can cause component or performance failure, loss of control, serious injury, or death. Even if you're an experienced bike rider, **you must read and understand the entire manual and any documentation provided for subcomponents or accessories before riding.** If you are not sure you have the experience, skills, and tools to correctly perform all assembly steps in the manual and the assembly video at [www.radpowerbikes.com/assemble](http://www.radpowerbikes.com/assemble), consult a local, certified, reputable bike mechanic.

### Be thoroughly educated about your bike before riding it

Practice riding your bike, braking, shifting gears, and using the throttle and pedal assist systems in a controlled location before venturing into traffic or other risky conditions.

The electrical system on your ebike offers various levels of power assistance and lighting for different operating conditions and user preferences. Be sure you understand these features before riding. The throttle should provide smooth acceleration when gradually applied. If the pedal assistance, throttle, or lighting is functioning abnormally, intermittently, or not at all, please discontinue using your ebike immediately and contact Rad Power Bikes Product Support for assistance.

Take extreme care getting to know and learning to control the pedal assist and brake systems. Your RadCity is probably heavier than other bikes you've ridden, and it will handle quite differently from lighter bikes, especially when you're accelerating or decelerating. Learn to maintain a comfortable stopping distance from all other objects, riders, and vehicles at different speeds, conditions, and with varying payloads.

### Age and ability requirements

The RadCity is designed for persons at least 16 years of age, and a parent or legal guardian should always decide whether a child should operate or ride on the RadCity or any other vehicle.

**NOTICE:** Some localities may require ebike riders to be older than 16. It is your responsibility to know and obey local regulations regarding rider age and other qualifications.

Riders must also have the physical ability, reaction time, and mental capability to understand and obey all local laws governing ebike usage and to manage traffic, variable road conditions, and sudden situations. If you have an impairment or disability (e.g., visual impairment, hearing impairment, physical impairment, cognitive or language impairment, seizure disorder) or any other limitation that could affect your ability to safely operate a vehicle, consult your physician before riding any bike.

 **DANGER:** Riding any bike under the influence of alcohol, drugs, or any substance or condition that could impair your motor function, judgment, reaction time, or ability to safely operate a vehicle puts you at VERY HIGH RISK of serious injury or death. Operate bikes and other vehicles only when you're sober and otherwise physically and mentally prepared to ride safely.

---

## Know and obey all relevant local laws

It is your responsibility to research and understand relevant laws where you ride your bike. Such laws may cover required helmets and safety gear, required lights and reflectors, required hand signals, where you can legally ride a bike (bikes and ebikes may have different restrictions), how fast you can go, what (if any) cargo or passengers you can carry, rider age, and more. Before using public transportation—buses, trains, etc.—to transport your ebike, check with the relevant transportation authority for any rules governing weight limits, tire widths, lithium-ion batteries, or any other rules that might pertain to ebikes.

When you ride on the road, assume you must, at minimum, follow all of the rules that cars must follow. For additional information regarding traffic and vehicle laws, contact the road traffic authority in your area.

---

## Safety check before each ride

Before each ride, you must check your bike to ensure everything is working properly. Follow the instructions on the [“Safety checklists” on page 27](#) and ground your safety checks in a solid understanding of bike maintenance, which is explained in [“Maintenance” on page 27](#), a section that includes an important chart, [“Recommended service intervals” on page 29](#), which you should follow as well.

If you are ever unsure how to check or maintain your bike or if you find any problems with it, take it to a certified, reputable bike mechanic or contact Rad Power Bikes Product Support.

---

## Ride appropriately for conditions

Always travel at speeds appropriate for local terrain and conditions as well as your experience level. **When in doubt, slow down.**

 **WARNING:** Using the front brake by itself can cause excessive stress on components, damage to the bike and parts, loss of control, injury, or death. Always apply the rear brake before applying the front brake, using both brakes for all operations.

Always use a low pedal assist level until you are comfortable with your RadCity and confident about controlling its power, weight, and responsiveness (e.g., during start-up, turns, and braking) at different speeds, in different conditions, and with whatever payloads you might carry.

**Riding with your headlight on** will make you more visible in any conditions. The headlight will turn on when the bike is powered on. We recommend you keep it on whenever you ride.

**Concentrate on the path ahead.** Avoid potholes, gravel, ice, wet or oily roads, wet leaves, curbs, train tracks, speed bumps, drain gates, thorns, broken glass, and other obstacles, hazards, and puncture-flat risks.

 **WARNING:** Crossing train tracks or similar grooved or raised surfaces at a diagonal can make the surface “grab” or deflect your wheel, causing your bike to suddenly get stuck or crash, leading to serious injury or death. Always cross such hazards at a perpendicular angle or, when in doubt, dismount and walk your bike across.

## PATH RIDING

Be a good citizen of shared-use paths and facilities. Keep your speed reasonable and below path speed limits, pass carefully and kindly. Use your voice and/or bell to signal your presence to others, especially when passing.

## ROAD RIDING

When riding on streets, obey the same road laws as all other road vehicles as well as local rules governing bike or ebike usage. Sharing the road with other vehicles presents many hazards. Always take these precautions:

- Expect the unexpected such as opening car doors or cars backing out of driveways.
- Be extra careful at intersections and when preparing to pass other vehicles or other cyclists.
- Ride predictably, in a straight line, and with the flow of traffic. **Never ride against traffic.**
- Use correct hand signals to indicate turning, and do so well in advance of turning.
- Ride defensively. To other road users you may be hard to see.
- Increase your visibility by following the tips in [“Low-visibility conditions” below](#).

## OFF-ROAD RIDING

Riding off road requires close attention and specific skills, and it presents variable conditions and hazards. Don't ride off road unless you have the appropriate skills. If you choose to ride off road, wear appropriate safety gear and do not ride alone in remote areas.

## HOT OR COLD CONDITIONS

Riding, parking, or storing your bike in excessively hot conditions can cause damage to the display and other components. Do not park or store your bike in direct sunlight for extended periods. For more information on safe and recommended temperature ranges for your battery, see [“Battery information” on page 14](#).

## LOW-VISIBILITY CONDITIONS



**WARNING:** Riding at night or in other low-visibility conditions (dawn, dusk, fog, rain, mist, snow, etc.) makes it harder to see and avoid hazards and makes it harder for others to see and avoid you, which increases risk of accidents, serious injury, or death. Wet, slippery surfaces will compound your risk of injury or death. Avoid these conditions whenever possible. If you must ride in these conditions, following the guidelines below can reduce risk.

- Wear reflective and brightly colored clothing.
- Slow down.
- Use familiar routes with street lighting if possible.
- Ensure tire wall, pedal, and other reflectors are installed and unobstructed.
- Ensure headlight and taillight/brake light are functioning correctly and unobstructed. Use them.

## WET CONDITIONS

This electric bike is not meant for use in puddles, heavy rain, or streams. Never immerse or submerge this product in water or liquid as the electrical system may be damaged.



**WARNING:** Riding in wet conditions means slippery hands, feet, and riding surfaces, which greatly increases your risk of accidents, serious injury, or death. Low-visibility conditions (night, dusk, dawn, fog, mist, rain, snow, etc.) will compound your risk of injury or death. If you must ride in wet conditions, following the guidelines below can mitigate risk somewhat.

- Decrease riding speed to help you control the bike in slippery conditions.
- Brake earlier since it will take longer to slow down than in dry conditions.
- Take care to be more visible to others on the road, following the tips in [“Low-visibility conditions” above](#).
- Remember that road hazards are more difficult to see when wet, so proceed with extra caution.

## EXTREME RIDING

There are no appropriate conditions for extreme riding. Although many articles, advertisements, and catalogs depict extreme riding, Rad Power Bikes strongly recommends against such inappropriate and dangerous use of its products.

 **DANGER:** Extreme riding puts you at **VERY HIGH RISK** of serious injury or death. Extreme riding includes but is not limited to jumps, stunts, or any riding that exceeds your capabilities or the strength and integrity limitations of certain bike components and/or otherwise leads to dangerous situations. Never engage in extreme riding or any type of riding that exceeds your capabilities.

---

## Wear a helmet and appropriate safety gear

We strongly advise that you and any passenger you carry wear a properly fitting, certified bicycle safety helmet while riding your bike, which may be required by law in your area.

**Wear appropriate safety gear** including closed-toe shoes. If you are wearing loose pants, secure the bottom using appropriate leg clips or bands to prevent the fabric from flapping and getting caught in the chain or other moving parts. Never use items such as headphones or hoods that can compromise your hearing or field of vision. A local, certified, and reputable bike shop can help advise you on what gear is best for the weather and other riding conditions in your area.

**Maximize your visibility** with bright colors and reflective outerwear or vests. Never compromise your ability to be seen or heard by removing your bike's reflectors, blocking or removing the headlight or taillight, or removing the bell.

 **DANGER:** Riding any bike without a helmet puts you at **VERY HIGH RISK** of serious head injury or death. Always wear a properly fitted helmet that covers the forehead. Many locations require specific safety devices. It is your responsibility to familiarize yourself and comply with the laws, rules, and regulations where you ride.

## Limited warranty and other terms

Your bike's warranty and other binding legal terms (e.g., terms of purchase, etc.) are subject to change at any time. To view your terms of purchase, go to [www.radpowerbikes.com/terms](http://www.radpowerbikes.com/terms). To view the current warranty, please go to [www.radpowerbikes.com/warranty](http://www.radpowerbikes.com/warranty).