

OWNER'S MANUAL

Operation
Maintenance
Specifications

All information in this Owner's Manual is current at the time of publication. However, HYUNDAI reserves the right to make changes at any time so that our policy of continual product improvement may be carried out.

This manual applies to all models of this vehicle and includes descriptions and explanations of optional as well as standard equipment. As a result, you may find material in this manual that does not apply to your specific vehicle.

CAUTION: MODIFICATIONS TO YOUR HYUNDAI

Your HYUNDAI should not be modified in any way. Such modifications may adversely affect the performance, safety or durability of your HYUNDAI and may, in addition, violate conditions of the limited warranties covering the vehicle. Certain modifications may also be in violation of regulations established by the Department of Transportation and other government agencies in your country.

TWO-WAY RADIO INSTALLATION

Your vehicle is equipped with a Tire Pressure Monitoring System, Passenger Occupant Classification System and other CAN bus systems. It is possible for an improperly installed/adjusted high powered two-way radio to adversely affect electronic systems. For this reason, we recommend that you carefully follow the radio manufacturer's instructions if you choose to install one of these devices.

SAFETY AND VEHICLE DAMAGE WARNING

This manual includes information titled as DANGER, WARNING, CAUTION and NOTICE.

These titles indicate the following:



DANGER

DANGER indicates a hazardous situation which, if not avoided, will result in death or serious injury.



WARNING

WARNING indicates a hazardous situation which, if not avoided, could result in death or serious injury.



CAUTION

CAUTION indicates a hazardous situation which, if not avoided, could result in minor or moderate injury.

NOTICE

NOTICE indicates a situation which, if not avoided, could result in vehicle damage.

HYUNDAI VEHICLE OWNER PRIVACY POLICY

Your Hyundai vehicle may be equipped with technologies and services that use information collected, generated, recorded or stored by the vehicle. Hyundai has created a Vehicle Owner Privacy Policy to explain how these technologies and services collect use and share this information.

You may read our Vehicle Owner Privacy Policy on the Hyundaiusa.com website at: <https://www.hyundaiusa.com/owner-privacy-policy.aspx>

If you would like to receive a hard copy of our Vehicle Owner Privacy Policy, please contact the Hyundai Customer Care Center at:

Hyundai Customer Care
P.O. Box 20850
Fountain Valley, CA 92728
800-633-5151
consumeraffairs@hmausa.com

Hyundai's Customer Care representatives are available Monday through Friday, between the hours of 6:00 AM and 5:00 PM PST and Saturday between 6:30 AM and 3:00 PM PST (English).

For Customer Care assistance in Spanish or Korean, representatives are available Monday through Friday between 6:30 AM and 3:00 PM PST.

Table of contents

Foreword / Starting your Electric vehicle	1
Vehicle Information, Consumer Information and Reporting Safety Defects	2
Seats & Safety System	3
Instrument Cluster	4
Convenience Features	5
Driving Your Vehicle	6
Driver Assistance System	7
Emergency Situations	8
Maintenance	9
Index	I

1. Foreword / Starting Your Electric Vehicle

- Electric Vehicle..... 1-7
 - Electric Vehicle..... 1-7
 - Characteristics of Electric Vehicles..... 1-7
 - Battery Information..... 1-7
- Main Components of Electric Vehicle 1-8
 - Main Components of Electric Vehicle 1-8
 - High Voltage Battery (lithium-ion battery)..... 1-8
 - High Voltage Battery Warmer System 1-9
- EV Mode 1-10
 - EV Mode Screen 1-10
 - Energy Information 1-11
 - Next Departure..... 1-11
 - Charging and Climate 1-12
 - Vehicle to Load (V2L) 1-14
 - Nearby Charging Stations..... 1-19
 - EV Settings..... 1-20
- Charge Types for Electric Vehicle 1-23
 - Charging Information..... 1-23
 - Charging Time Information 1-23
 - Charging Types..... 1-24
- Charge Indicator Lamp for Electric Vehicle 1-25
 - Charging Status..... 1-25
- Charging Connector Lock 1-26
 - Locking Charging Cable..... 1-26
- Scheduled Charging 1-27
 - Scheduled Charging..... 1-27
- Charging Electric Vehicle 1-28
 - Electric Charging Door 1-28
 - Charging Precautions 1-29
 - How to Check the Symbol on the Charging Label..... 1-30
 - Disconnecting Charging Connector in Emergency 1-31
 - AC Charge..... 1-31
 - DC Charge..... 1-34
 - Portable Charge (Type A)..... 1-36
 - Portable Charge (Type B)..... 1-49
- Charging the Electric Vehicle (abrupt stop) 1-59
 - Action to be taken when charging stops abruptly..... 1-59

Driving Electric Vehicle	1-60
How to Start the Vehicle	1-60
How to Stop the Vehicle	1-60
Virtual Engine Sound System	1-61
Distance to Empty	1-61
Tips for Improving Distance to Empty	1-62
ECO Driving	1-63
Electricity Use.....	1-63
Power/Charge Gauge	1-64
State Of Charge (SOC) Gauge for High Voltage Battery.....	1-64
Aux. Battery Saver+	1-65
Warning and Indicator Lights (related to electric vehicle)	1-66
LCD Display Messages.....	1-68
Safety Precautions for Electric Vehicle	1-73
If an Accident Occurs.....	1-73
Other Precautions for Electric Vehicle.....	1-74
High Voltage cut-off Switch	1-75

FOREWORD

Congratulations, and thank you for choosing HYUNDAI. We are pleased to welcome you to the growing number of discerning people who drive HYUNDALs. We are very proud of the advanced engineering and high-quality construction of each HYUNDAI we build.

Your Owner's Manual will introduce you to the features and operation of your new HYUNDAI. To become familiar with your new HYUNDAI, so that you can fully enjoy it, read this Owner's Manual carefully before driving your new vehicle.

This manual contains important safety information and instructions intended to familiarize you with your vehicle's controls and safety features so you can safely operate your vehicle.

This manual also contains information on maintenance designed to enhance safe operation of the vehicle. It is recommended that all service and maintenance on your car be performed by an authorized HYUNDAI dealer. HYUNDAI dealers are prepared to provide high-quality service, maintenance and any other assistance that may be required.

This Owner's Manual should be considered a permanent part of your vehicle, and should be kept in the vehicle so you can refer to it at any time. The manual should stay with the vehicle if you sell it to provide the next owner with important operating, safety and maintenance information.

HYUNDAI MOTOR AMERICA



CAUTION

Severe vehicle damage may result from the use of poor quality lubricants that do not meet HYUNDAI specifications. You must always use high quality lubricants that meet the specifications listed on Page 2-12 in the Vehicle Specifications section of the Owner's Manual.

Copyright 2022 HYUNDAI Motor America. All rights reserved. No part of this publication may be reproduced, stored in any retrieval system or transmitted in any form or by any means without the prior written permission of HYUNDAI Motor America.

HOW TO USE THIS MANUAL

We want to help you get the greatest possible driving pleasure from your vehicle. Your Owner's Manual can assist you in many ways. We strongly recommend that you read the entire manual. In order to minimize the chance of death or injury, you must read the WARNING and CAUTION sections in the manual.

Illustrations complement the words in this manual to best explain how to enjoy your vehicle. By reading your manual, you will learn about features, important safety information, and driving tips under various road conditions.

The general layout of the manual is provided in the Table of Contents. Use the index when looking for a specific area or subject; it has an alphabetical listing of all information in your manual.

Sections: This manual has nine chapters plus an index. Each section begins with a brief list of contents so you can tell at a glance if that section has the information you want.

SAFETY MESSAGES

Your safety, and the safety of others, is very important. This Owner's Manual provides you with many safety precautions and operating procedures. This information alerts you to potential hazards that may hurt you or others, as well as damage to your vehicle.

Safety messages found on vehicle labels and in this manual describe these hazards and what to do to avoid or reduce the risks.

Warnings and instructions contained in this manual are for your safety. Failure to follow safety warnings and instructions can lead to serious injury or death.

Throughout this manual DANGER, WARNING, CAUTION, NOTICE and the SAFETY ALERT SYMBOL will be used.



This is the safety alert symbol. It is used to alert you to potential physical injury hazards. Obey all safety messages that follow this symbol to avoid possible injury or death. The safety alert symbol precedes the signal words DANGER, WARNING and CAUTION.



DANGER

DANGER indicates a hazardous situation which, if not avoided, will result in death or serious injury.



CAUTION

CAUTION indicates a hazardous situation which, if not avoided, could result in minor or moderate injury.



WARNING

WARNING indicates a hazardous situation which, if not avoided, could result in death or serious injury.

NOTICE

NOTICE indicates a situation which, if not avoided, could result in vehicle damage.

VEHICLE MODIFICATIONS

- This vehicle should not be modified. Modification of your vehicle could affect its performance, safety or durability and may even violate governmental safety and emissions regulations.
In addition, damage or performance problems resulting from any modification may not be covered under warranty.
- If you use unauthorized electronic devices, it may cause the vehicle to operate abnormally, wire damage, battery discharge and fire. For your safety, do not use unauthorized electronic devices.



WARNING

CALIFORNIA PROPOSITION 65 WARNING

Items contained in motor vehicles or emitted from them are known to the State of California to cause cancer and birth defects or reproductive harm.

These include:

- **Gasoline and its vapors**
- **Engine exhaust**
- **Used engine oil**
- **Interior passenger compartment components and materials**
- **Component parts which are subject to heat and wear**

In addition, battery posts, terminals and related accessories contain lead, lead compounds and other chemicals known to the State of California to cause cancer and reproductive harm.

VEHICLE DATA COLLECTION AND EVENT DATA RECORDERS

This vehicle is equipped with an event data recorder (EDR). The main purpose of an EDR is to record, in certain crash or near crash-like situations, such as an air bag deployment or hitting a road obstacle, data that will assist in understanding how a vehicle's systems performed. The EDR is designed to record data related to vehicle dynamics and safety systems for a short period of time, typically 30 seconds or less. The EDR in this vehicle is designed to record such data as:

- How various systems in your vehicle were operating;
- Whether or not the driver and passenger safety belts were buckled/ fastened;
- How far (if at all) the driver was depressing the accelerator and/or brake pedal; and,
- How fast the vehicle was traveling.

These data can help provide a better understanding of the circumstances in which crashes and injuries occur. NOTE: EDR data are recorded by your vehicle only if a non-trivial crash situation occurs; no data are recorded by the EDR under normal driving conditions and no personal data (for example, name, gender, age, and crash location) are recorded. However, other parties, such as law enforcement, could combine the EDR data with the type of personally identifying data routinely acquired during a crash investigation.

To read data recorded by an EDR, special equipment is required, and access to the vehicle or the EDR is needed. In addition to the vehicle manufacturer, other parties, such as law enforcement, that have the special equipment, can read the information if they have access to the vehicle or the EDR.

ELECTRIC VEHICLE

Electric Vehicle

An electric vehicle is driven using a battery and an electric motor. While general vehicles use an internal combustion engine and gasoline as fuel, electric vehicles use electrical energy that is charged inside the high voltage battery. As a result, electric vehicles are eco-friendly in that they do not require fuel and do not emit exhaust gases.

Characteristics of Electric Vehicles

1. It is driven using the electrical energy that is charged inside the high voltage battery. This method prevents air pollution since fuel, like gasoline, is not required, negating the emission of exhaust gases.
2. A high performance motor is used in the vehicle as well. Compared to standard, internal combustion engine vehicles, engine noise and vibrations are much more minimal when driving.
3. When decelerating or driving downhill, regenerative braking is utilized to charge the high voltage battery. This minimizes energy loss and increases the distance to empty.
4. When the battery charge is not sufficient, AC charge, DC charge and trickle charge are available. (Refer to “Charge Types for Electric Vehicle” for details.)

Information

What does regenerative braking do?

It uses an electric motor when decelerating and braking and transforms kinetic energy to electrical energy in order to charge the high voltage battery. (Torque is applied in the opposite direction when decelerating to generate braking force and electric energy.)

Battery Information

- The vehicle is composed of a high voltage battery that drives the motor and air-conditioner, and an auxiliary battery (12 V) that drives the lamps, wipers, and audio system.
- The auxiliary battery is automatically charged when the vehicle is in the ready (**READY**) mode or the high voltage battery is being charged.

MAIN COMPONENTS OF ELECTRIC VEHICLE

Main Components of Electric Vehicle

- On-Board Charger (OBC) : A device that charges the high voltage battery by converting AC power of the power grid to DC power.
 - Inverter : Transforms direct current into alternate current to supply power to the motor, and transforms alternate current into direct current to charge the high voltage battery.
 - LDC : Transforms power from the high voltage battery to low voltage (12 V) to supply power to the vehicle (DC-DC).
 - VCU : Control the various controls on the vehicle.
 - Motor : Uses electrical energy stored inside the high voltage battery to drive the vehicle (functions like an engine in a standard vehicle).
 - Reduction gear : Delivers rotational force of the motor to the tires at appropriate speeds and torque.
 - High voltage battery (lithium-ion battery) : Stores and supplies power necessary for the electric vehicle to operate (12 V auxiliary battery provides power to the vehicle features such as lights and wipers).
- * OBC : On-Board Charger
* LDC : Low Voltage DC-DC Converter
* VCU : Vehicle Control Unit



WARNING

- **Do not intentionally remove or disassemble high voltage components and high voltage battery connectors and wires. Also, be careful not to damage high voltage components and the high voltage battery. It may cause serious injury and significantly impact the performance and durability of the vehicle.**
- **When inspection and maintenance is required for high voltage components and the high voltage battery, contact an authorized HYUNDAI dealer.**

High Voltage Battery (lithium-ion battery)

- The charge amount of the high voltage battery may gradually decrease when the vehicle is not being driven.
- The battery capacity of the high voltage battery may decrease when the vehicle is stored in high/low temperatures.
- Distance to empty may vary depending on the driving conditions (such as outside temperature), even if the charge amount is the same. The high voltage battery may expend more energy when driving at high-speed or uphill. These actions may reduce the distance to empty.
- The high voltage battery is used when using the air-conditioner / heater. This may reduce the distance to empty. Make sure to set moderate temperatures when using the air-conditioner/heater.

- Natural degradation may occur with the high voltage battery depending on the number of years the vehicle is used. This may reduce the distance to empty.
- When the charge capacity and distance to empty keep falling, contact an authorized HYUNDAI dealer for inspection and maintenance.
- If the vehicle will not be in use for an extended period of time, charge the high voltage battery once every three months to prevent it from discharging. Also, if the charge amount is not enough, immediately charge to full and store the vehicle.
- AC charge is recommended to keep the high voltage battery in optimal condition.

If the high voltage battery charge amount is below 20%, you can keep the high voltage battery performance in optimal condition if you charge the high voltage battery to 100%. (Once a month or more is recommended.)

The value of the high voltage battery charge level may vary according to the charging conditions (state of charger, outside temperature, battery temperature, etc.). In order to fully charge the battery, the current of the high voltage battery will be gradually decreased, so that the longevity and safety of the battery can be secured.



CAUTION

- **If the vehicle is kept with insufficient charge for a long period, it may damage the high voltage battery and the high voltage battery may have to be replaced depending on the level of degradation.**
- **If the vehicle is in a collision, contact an authorized HYUNDAI dealer to inspect whether the high voltage battery is still connected.**
- **Using the V2L function may reduce the mileage due to the use of high voltage battery energy, and repeated use of the V2L function may cause a decrease in the life of the high voltage battery.**

High Voltage Battery Warmer System

The high voltage battery warmer system prevents reduction of battery output when battery temperature is low. If the charging connector is connected, the warmer system automatically operates according to the battery temperature.

Charging time may shorten compare to vehicles without the high voltage battery warmer system. But, electricity charge may increase because of high voltage battery warmer system operation.



CAUTION

The high voltage battery warmer system operates when the charging connector is connected to the vehicle.

However, the high voltage warmer system may not operate when battery temperature drops below -31°F (-35°C).

EV MODE



If you select the “EV” menu at the home screen you can enter EV mode.

For detailed information, refer to the separately supplied infotainment system manual.

EV Mode Screen



1. Energy Information
2. Next Departure
3. Charging and Climate
4. Vehicle to Load (V2L)
5. Nearby Stations
6. EV Settings
7. Menu

Energy Information

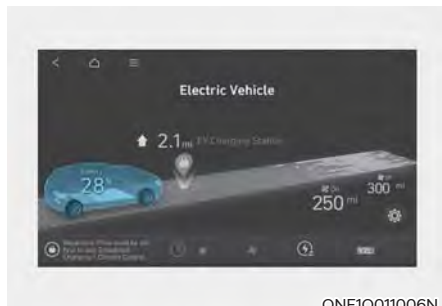

Select 'EV → Vehicle image' on the screen.

You can check battery information and energy consumption.

Battery information

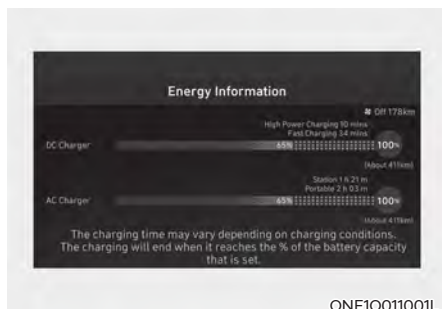

You can check the reachable range, total battery power remaining, and expected charging time for each charge type.

- The distance to empty is calculated based on the real-time electric energy efficiency while driving. The distance may change if the driving pattern changes.
- The distance to empty may vary according to the change of the driving pattern even if the same target battery charge level is set.

Next Departure

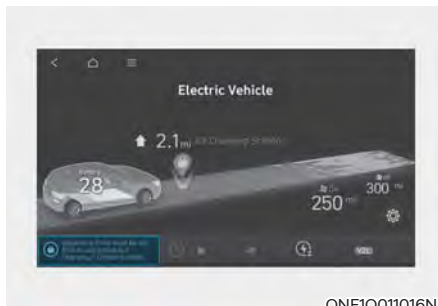

Select 'EV → Next Departure' on the screen. You can set the date and time of when to charge the battery, climate control temperature, and other various functions.

Departure time

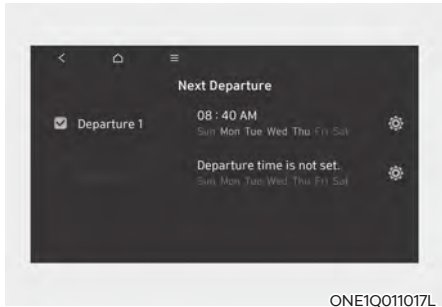

ONE1Q011017L

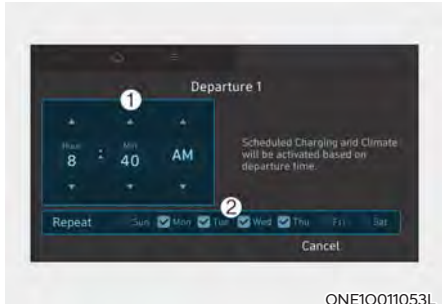

ONE1Q011053L

1. Set anticipated departure time for scheduled charging and target temperature.
2. Select the day of the week to activate scheduled charging and target temperature for departure time.

Charging and Climate

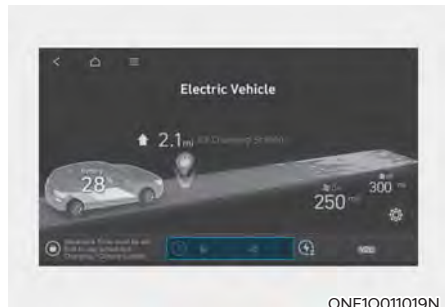

ONE1Q011019N

Select 'EV → Charging and Climate' on the screen.

Information

Vehicle must be connected with the charging connector at the time pre-scheduled time for the scheduled charging.

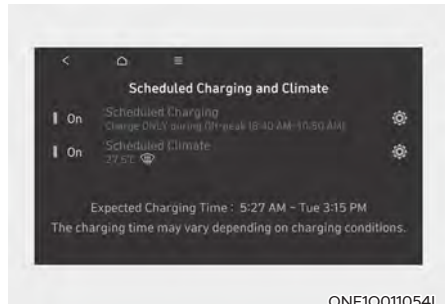

ONE1Q011054L

You can set the date and time of when to charge the battery and the climate control temperature. Also, you may select the time to start charging using the off-peak time setting.

Off-peak time settings

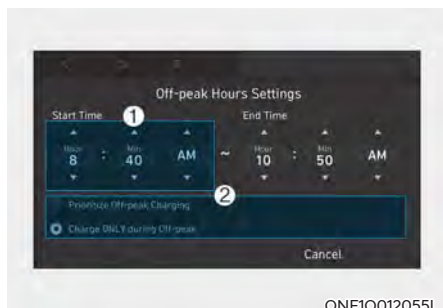

1. If selected, starts charging only on the designated off-peak time. If deselected, starts charging only on the scheduled time.
2. Set the most inexpensive time to complete charging.
 - Off-peak tariffs prioritized: If selected, starts charging at off-peak time(may keep on charging pass off-peak time to charge 100%).
 - Charge only during Off-peak: If selected, charges only within off-peak time(may not charge 100%).

Target temperature settings

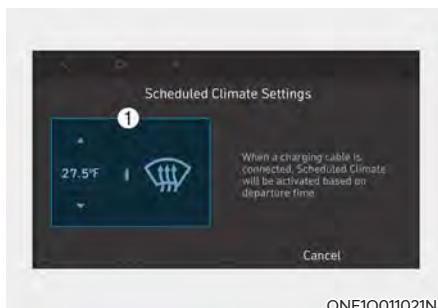

1. Set target temperature.
 - If the target temperature (1) is set with the cable connected, the cabin temperature will be adjusted to the target temperature at departure time (without loss of high voltage battery charging level). In cold weather, preschedule heating helps enhance electric vehicle performance by heating the vehicle in advance.

Vehicle to Load (V2L) (if equipped)

V2L is the system that provides AC power using the high voltage battery for driving to operate several electrical products.



ONE1Q011022N

Select 'EV → Vehicle to Load (V2L)' on the screen.

You can set the battery discharging limit for high voltage battery for driving.

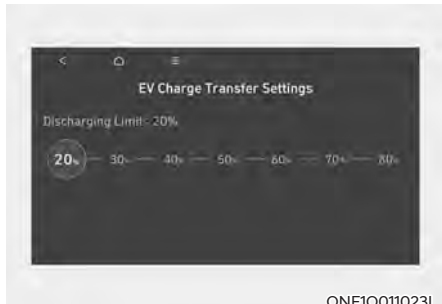

ONE1Q011023L

If the vehicle reaches to the limit, it automatically cut supply of electricity.

Energy information

Select 'EV → Vehicle image' on the screen.

You can check battery discharging level.

How to connect

Outdoor

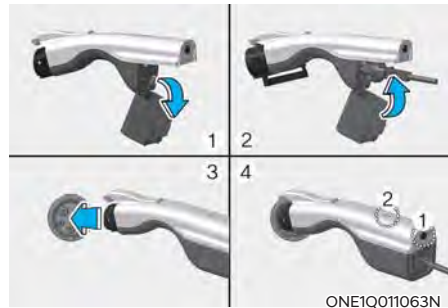

ONE1Q011063N

1. Open the cover of the V2L connector.
2. Close the cover after connecting home appliances and electrical products to the power outlet.

WARNING

Some types of plugs may not fit into the outlet cover of the V2L connector, causing incomplete closing of the cover.

Do not use the V2L connector on a rainy or snowy day if the outlet cover is not completely closed. There is a risk of fire and/or injury.

3. Connect the V2L connector to the charging inlet on the vehicle.
4. Press the switch (1) of the V2L connector and check whether the light (2) is on or off. The light (2) may not turn on normally when:
 - See the battery discharging limit for high voltage battery for driving in 'Electricity Use' menu on the screen. If it is higher than the current amounts of high voltage battery, the light (2) does not turn on.
 - Check whether the light of V2L connector or indoor power outlet turns on or not.
 - If the warning message for V2L appears on the cluster, refer to the message entirely.
 - If V2L does not operate previously when you connects another home appliances, have your vehicle inspected by an authorized HYUNDAI dealer.
5. Press the switch (1) to turn off the light (2) the the V2L will be off. You can disconnect the V2 connector when the light (2) turns off or the charging connector lock is deactivated pressing the door unlock button on the smart key.

i Information

Please connect the V2L connector to the charging inlet within 60 seconds after the charging cover opens. To prevent theft after connecting, it is changed to auto lock automatically so that it is impossible to disconnect.

When using V2L, cancel the scheduled air conditioning setting. V2L operation may be blocked by scheduled air conditioning operation conditions.

Indoor



ONE1051084N

1. Connect to the power outlet located in bottom of the rear seat with the Vehicle Stop/Start button in the ON position.



ONE1Q011089

2. Use the smart key to unlock the power outlet cover.



3. Check the operation status through the front indicator of the power outlet.
- Blue: Standby
 - Red: No power supply even the power outlet is connected
 - Green: Normal power supply through the normal connection of the power outlet.

i Information

When the used power is exceeded due to overload, the use of V2L is stopped and the “V2L function is stopped due to excess power“ message appears in the cluster. Disconnect the electronic product to reset the V2L and follow as below.

- After removing the outdoor V2L connector, it can be used again by reconnecting it.
- When using only indoor V2L with the vehicle ON, if V2L is terminated due to overload, it can be used only after restarting.

i Information

- V2L discharging mode will shut off if the vehicle is off using indoor V2L on the vehicle state of ON.
- Opening the charging door or connecting the V2L connector to the charging inlet, the V2L discharging mode will shut off. If you want to use the indoor and outdoor V2L simultaneously, firstly connect the V2L connector to the charging inlet and use the indoor V2L.

! CAUTION

- Be well-informed of the manual to prevent accidents.
- The V2L discharging mode is blocked automatically in case of overheating. (When the discharging mode is blocked, check whether the V2L connector or power plug is contaminated, worn, corroded or broken or the home appliance capacity is over 16 A. If the temperature falls to proper level after it is left unattended, you can use it again. Use proper home appliances.)
- Do not remodel or disassemble the provided V2L connector. The failure caused by remodeling or disassembling is not covered by the warranty.
- Do not drop the V2L connector or give a strong impact to it.
- Do not place objects on the V2L connector.
- Be sure to disconnect the V2L connector from the vehicle when you are finished using V2L.
- When the high voltage battery charge reaches the set discharging limit(%), the operation stops, and a warning message is displayed on the instrument panel. If you want V2L operation, set the discharging limit(%) lower than the current battery charge.

- When using various electric products, use them below the maximum power capacity that can be supplied by the vehicle.
- If you use an electrical appliance that exceeds the maximum power capacity that the vehicle can supply, the operation will stop and a warning message will be displayed on the instrument panel. Make sure the total power consumption of the electrical appliance you use exceeds the V2L maximum power capacity.
- Some of the electric products may not operate normally even if the product has power consumption less than the maximum power capacity provided by the vehicle.
 - Electrical products that require high power during initial operation.
 - Measuring devices that need to process accurate data.
 - Electric products sensitive to inverter type AC power supply (Inverter: A device that converts DC power into AC power)
- Do not use products that require a continuous power supply, such as medical equipment. The power supply may be interrupted depending on the vehicle's condition.
- Only use home appliances under 16 ampere.
- Put the power plug fully and use the qualified plug that meets the standard. If you use worn, corroded or broken plug or improper plug, it might be a cause of malfunction.
- Use a power plug with ground connection.
- Do not use high power home appliances such as air conditioning, washing machine or dryer.
- Do not hang the home appliances on to the wire.
- For various devices connected to a power outlet, use only products that have obtained national safety certification. For usage and precautions, refer to the manual of the device. (Electrical appliances, multi-outlets, cord extension cables, etc.)
- For devices used outdoors in a vehicle, use a product with a waterproof function or use it in a waterproof environment. Do not use in environments with rain or high humidity. (Electrical appliances, multi-outlets, cord extension cables, etc.)
- If there is a risk of lightning, do not use the V2L function outside the vehicle.
- Do not connect multiple portable multi-outlets.
- When using an extension cable, if the cable is twisted or overlapped by itself may cause a fire. Be sure to use the cable without twisting it.
- When using the vehicle's outdoor V2L connector, power is also supplied to the vehicle's indoor power outlet. Unplug electrical appliances that are not in use from the indoor power outlet.
- When using the V2L, the cooling fan in the vehicle motor compartment can operate automatically even if the vehicle is turned off. Do not put your hand near the cooling fan in the V2L operating state.



WARNING

- Do not touch the V2L connector of the terminal of the vehicle charging inlet.
- Do not put metal objects to the V2L connector or charging inlet. It might be a cause of electric shock.
- Do not touch the V2L connector, charging inlet or power plug with a wet hand. It might be a cause of electric shock. Please handle with a dry hand all the time.
- Confirm whether there is foreign substance such as water or dust on the V2L connector, charging inlet or power plug before connecting. If you connect it with foreign substances, it may be a cause of fire or electric shock.
- Do not remodel or disassemble the V2L connector. There is a risk of fire, electric shock or injury.
- When the power plug is connected or disconnected to the V2L connector or open or close the connector cover of the V2L, be careful not to be scratched on the hand.
- Do not charge in the following conditions. The accident might occur.
 - The V2L connector, charging inlet, power plug or cable is damaged, corroded or rusted.
 - The connection part is loose.
- Do not use if the sheath of home appliance cables is damaged or broken. There is a risk of fire, electric shock or injury.
- Never use an electric heating appliance like iron, coffee pot, and toaster in the vehicle. It may cause a fire and injury.

LCD display messages



ONE1Q011077L

V2L has ended. Battery level has reached the set value

When the high voltage battery level reaches the discharging limit set level, the V2L will stop and the warning will be displayed. If you want to use the V2L continuously, make the discharging limit set level lower than the present battery level.



ONE1Q011078L

V2L stopped due to excessive power use

If you use an electrical appliance that exceeds the maximum power output the vehicle can supply, it will stop working and display a warning message. Make sure that the total power consumption of your electrical appliance exceeds the V2L maximum power output.



ONE1Q011079L

V2L conditions not met

If V2L is interrupted for any of the following reasons, a warning message is displayed.

- V2L connector switch off
- V2L connector overheating
- Opening the charging door while using the V2L indoor outlet

Make sure there are no problems with the V2L connector and the vehicle indoor outlet.

Nearby Charging Stations

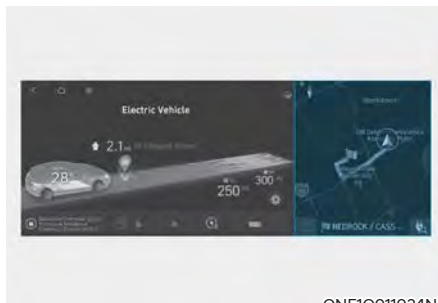

ONE1Q011024N

Select 'EV → Map' on the screen. Stations around the current location are searched.

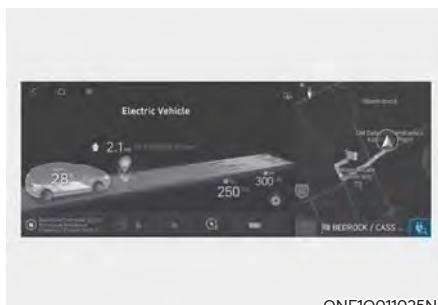

ONE1Q011025N

Select 'Search for charging stations' on the screen.



ONE1Q011026N

Around the course, around the current site, around the selected destination or charging stations of interest will be searched. If you choose the charging station, the detailed information will be provided.

For more detailed information, please refer to the separately supplied infotainment system manual.

EV Settings

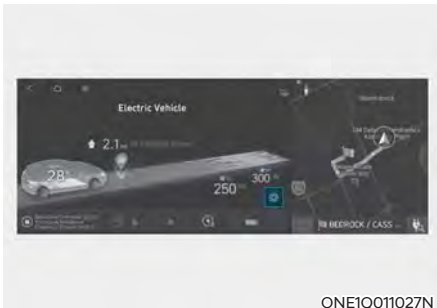

ONE1Q011027N

Select 'EV → EV Settings' on the screen. You can set the charging limit, charging current, winter mode and utility mode functions.

Charging limit (Max. % Charge)

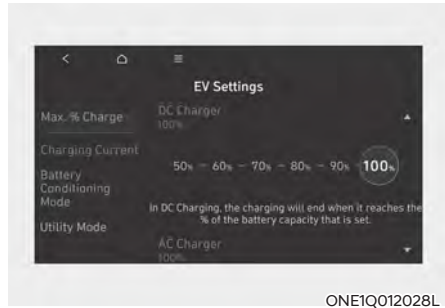

ONE1Q012028L

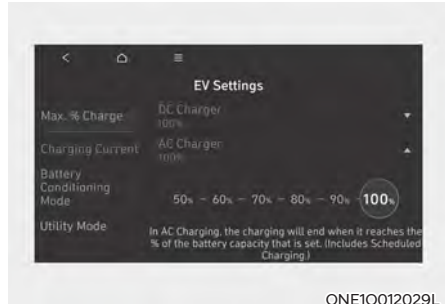

ONE1Q012029L

- The target battery charge level can be selected when charged with AC charger or DC charger.
- The charging level can be changed by 10%.
- If the target battery charge level is lower than the high voltage battery charge level, the battery will not be charged.

Charging current

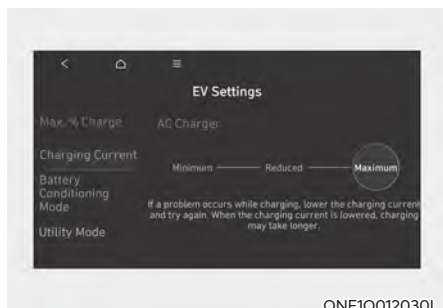

- You can adjust the charging current for an AC charger. Select an appropriate charging current.
- If the charging process does not start or abruptly stops in the middle, reselect another proper current and re-try charging the vehicle.
- Charging time varies depending on which charging current is selected.

Battery conditioning mode (if equipped)

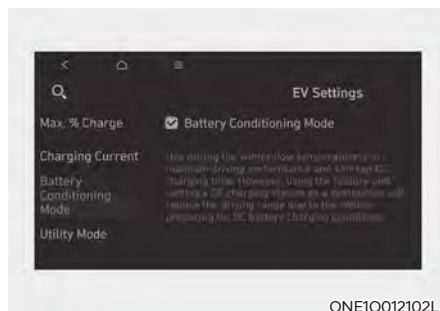

You can select or deselect the Battery conditioning mode.

The Battery conditioning mode is efficient during the winter time when the high voltage battery temperature is low.

This mode is recommended to improve driving and DC charging performances during winter by raising the battery temperature to an adequate level.

However, the driving distance may be reduced as the energy is required to increase battery temperature.

Also, if the battery temperature is low during driving or when the scheduled air conditioner/heater is activated, this mode is operated to improve driving performance.

However, the mode is not operated to ensure driving distance when the battery level is low.

i Information

This mode is available for the vehicles equipped with the battery heater.

Utility Mode

The high voltage battery is used instead of the 12V auxiliary battery for operating the convenient features of the vehicle. When driving is not necessary such as while camping or when stopping the vehicle for a long time, it is possible to use the electrical devices (audio, lights, air conditioner, heater, etc.) for long hours.

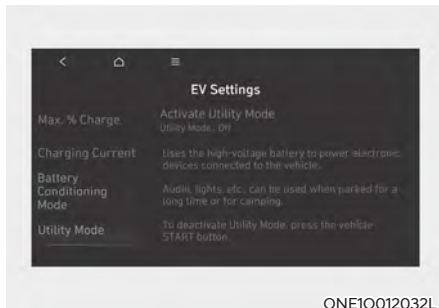

System Setting and Activation

System setting

The driver can activate the Utility mode function when the following conditions are satisfied.

- The vehicle is in the ready (**READY**) mode and the gear is shifted to P (Park).
- The EPB (Electronic Parking Brake) is not a malfunction.
- 'EV settings → Utility mode' is selected on the infotainment system screen.

System Activation

When the system is activated:

- The (**READY**) indicator will turn off, and the (**UTIL**) indicator will illuminate on the cluster and the EPB is applied.
- All electric devices are usable but the vehicle cannot be driven.
- The EPB can be cancelled by pressing the EPB switch.

Gear cannot be shifted out of P (Park). If a shift attempt is made, a message "Shifting conditions not met" will be displayed on the infotainment system screen.

System Deactivation

The Utility mode can be deactivated by pressing the START/STOP button to the OFF position. The function cannot be deactivated from the EV settings.

CHARGE TYPES FOR ELECTRIC VEHICLE

Charging Information

- **AC Charge:** The electric vehicle is charged by plugging into a AC charger installed at your home or a public charging station. (For further details, refer to the 'AC Charge'.)
- **DC Charge:** You can charge at high speeds at public charging stations. Refer to the respective company's manual that is provided for each DC charger type.
Battery performance and durability can deteriorate if the DC charger is used constantly.
Use of DC charge should be minimized in order to help prolong high voltage battery life.
- **Portable Charge:** The Electric vehicle can be charged by using household electricity. The electrical outlet at your home must comply with regulations and can safely accommodate the Voltage / Current (Amps) / Power (Watts) ratings specified on the portable charge.









Charging Time Information

Charging type		Standard battery type	Extended battery type
AC charge		Takes approx. 5 hours 50 minutes at room temperature when charged to 100%	Takes approx. 7 hours 10 minutes at room temperature when charged to 100%.
DC charge	350 kW charger	Takes about 18 minutes at room temperature when charged from 10% to 80%. Can be charged to 100%.	Takes about 18 minutes at room temperature when charged from 10% to 80%. Can be charged to 100%.
	50 kW charger	Takes about 63 minutes at room temperature when charged from 10% to 80%. Can be charged to 100%.	Takes about 66 minutes at room temperature when charged from 10% to 80%. Can be charged to 100%.
Portable charge		Takes approx. 51 hours 5 minutes at room temperature when charged to 100%.	Takes approx. 68 hours at room temperature when charged to 100%.

Information

Depending on the condition and durability of the high voltage battery, charger specifications, and ambient temperature, the time required for charging the high voltage battery may vary.

Charging Types

Category	AC Charge	DC Charge	Portable Charge
Charging Inlet (Vehicle)	 ONE1Q011036	 ONE1Q011037	 ONE1Q011036
Charging Connector	 ONE1Q011083	 OAEEQ016079N	 ONE1Q011083
Charging Outlet	 OLFP0Q4057N	 OAEEQ016023	 ONX4EPHQ011019L
How to Charge	Use AC charger installed at home or public charging stations	Use the DC charger at public charging stations	Use household current

- Depending on the condition and durability of the high voltage battery, charger specifications, and ambient temperature, the time required for charging the high voltage battery may vary.
- Actual charger image and charging method may vary in accordance with the charger manufacturer.

i Information

Type 3R, when mating with outlets.

Additional Type 3R enclosure should be provided in the end installation.

⚠ CAUTION

- Risk of electric shock, do not disconnect under load.
- Suitable for use on a circuit capable of delivering not more than 30000 rms symmetrical amperes, 1000 volts maximum

CHARGE INDICATOR LAMP FOR ELECTRIC VEHICLE

When charging the high voltage battery, the charge level can be checked from outside the vehicle.

Charging Status

Electric charging door



Lamp status	Battery SOC [%]
	0 ~ 24
	25 ~ 49
	50 ~ 74
	75 ~ 100

Front Center Bumper (if equipped)



Lamp status	Battery SOC [%]
	0 ~ 20
	21 ~ 40
	41 ~ 60
	61 ~ 80
	81 ~ 100

High voltage indicator

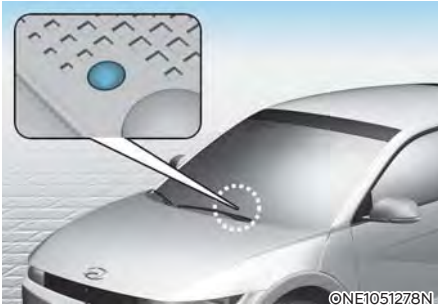

The high voltage indicator is located on top of the crash pad.

When the 12 volt auxiliary battery is discharged, it is charged from the high voltage battery of the vehicle.

When the high voltage electricity flow in the vehicle, the color of the indicator changes to amber and turns off after charging is finished.

WARNING

When the function is activating, the Charging Indicator Lamp will turn on and high voltage electricity will be flowing in the vehicle. Do not touch the high voltage electric wire (orange), connector, and all electric components and devices. This may cause electric shock and lead to injuries. Also, do not modify your vehicle in any way. This may affect your vehicle performance and lead to an accident.

CHARGING CONNECTOR LOCK

Locking Charging Cable

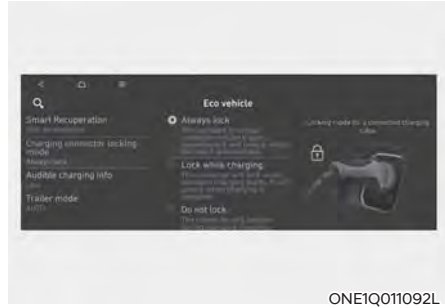

You may select when the charging connector can be locked and unlocked in the charging inlet.

Select 'Settings → ECO Vehicle → Charging Connector Locking Mode' in the infotainment.

When the Charging Connector Is Locked

	Always lock	Lock while charging	Do not lock
Before charging	O	X	X
While charging	O	O	X
Finished charging	O	X	X

- ‘Always lock’ mode :
The connector locks when the charging connector is plugged into the charging inlet. The connector is locked until all doors are unlocked by the driver. This mode can be used to prevent charging cable theft.
 - If the charging connector is unlocked when all doors are unlocked, but the charging cable is not disconnected within 15 seconds, the connector will be automatically locked again.
 - If the charging connector is unlocked when all doors are unlocked, but all doors are locked again, immediately, the connector will be automatically locked again.
- ‘Lock while charging’ mode :
The connector locks when charging starts. The connector unlocks when charging is complete. This mode can be used when charging in a public charging station.
- ‘Do not lock’ mode :
The connector unlocks regardless of the state of charging.
Press the charging connector release button, disconnect the connector.
Be careful to theft of the charging cable.

SCHEDULED CHARGING

Scheduled Charging (if equipped)

- You can set-up a charging schedule for your vehicle using the Infotainment system or Blue Link application.
Refer to the infotainment system manual or the Blue Link application for detailed information about setting scheduled charging.
- Scheduled charging can only be done when using a AC charger or the portable charger (ICCB: In-Cable Control Box).



©NE1Q0T1039

- When scheduled charging is set and the AC charger or the portable charger (ICCB: In-Cable Control Box) is connected for charging, the indicator lamp blinks from the first level to the last for about 3 minutes to indicate that scheduled charging is set.
- When scheduled charging is set, charging is not initiated immediately when the AC charger or portable charger (ICCB: In-Cable Control Box) is connected. When immediate charging is required, press the charging door open button in the smart key for 2 seconds or deactivate the scheduled charge setting with the infotainment system or Blue Link application.

Refer to “AC Charge (Station) or Trickle Charge” for details about connecting the AC charger and the portable charger (ICCB: In-Cable Control Box).

CHARGING ELECTRIC VEHICLE

Electric Charging Door

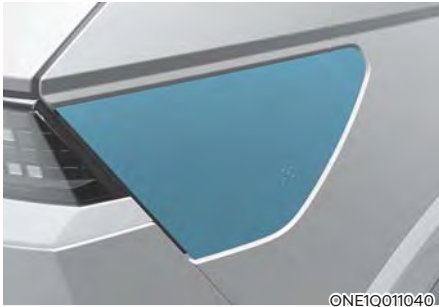

The electric charging door will open and close as follows.

Methods	Open	Close
Touch and Push	<p>ONE1Q011064</p>	<p>ONE1Q011067</p>
Smart Key	<p>ONE1Q011066</p>	
Voice Recognition	<p>WNE1-208 (Limited to areas where voice recognition is applied)</p>	

i Information

- **The charging door automatically closes when:**
 - **The charging connector is disconnected**
 - **The charging procedure has not done for a certain amount of time while the charging door is opened.**
 - **The gear is in D (drive), N (neutral), or R (Reverse).**
- **After replacing battery (12 volt), open and close the charging door once to check that the charging door automatic opening mechanism is functioning properly.**
- **When replacing the charging door, be sure to disconnect the vehicle-side wiring connector of the charging door module and reconnect it to ensure normal operation of the charging door.**

Charging Precautions

■ AC Charger



OLFP0Q4057N

■ DC Charger



OAEEQ016023

Actual charger image and charging method may vary in accordance with the charger manufacturer.

WARNING

- Electromagnetic waves that are generated from the charger can seriously impact medical electric devices such as an implantable cardiac pacemaker.
If you are fitted with any electronic medical implants (for example, cardiac pacemaker), make sure to ask the medical team and manufacturer whether charging your electric vehicle will impact the operation of electronic medical implants.
- Check to make sure there is no water or dust on the charging cable connector and plug before connecting to the charger and charging inlet. Connecting while there is water or dust on the charging cable connector and plug may cause a fire or electric shock.

WARNING

- Be careful not to touch the charging connector, charging plug, and the charging inlet when connecting the cable to the charger and the charging inlet on the vehicle.
- Comply with the following in order to prevent electrical shock when charging:
 - Use a waterproof charger.
 - Do not touch the charging connector and charging plug with your hands wet, or do not stand in water or snow while connecting the charging cable.
 - Be careful when there is lightning.
 - Be careful when the charging connector and plug are wet.

WARNING

- Immediately stop charging when you find abnormal symptoms (odor, smoke).
- Replace the charging cable if the cable coating is damaged to prevent electrical shock.
- When connecting or removing the charging cable, make sure to hold the charging connector handle and charging plug.

If you pull the cable itself (without using the handle), the internal wires may be disconnected or get damaged. This may lead to electric shock or fire.

CAUTION

- Always keep the charging connector and charging plug in clean and dry condition. Be sure to keep the charging cable in a condition where there is no water or moisture.
- Be sure to use only certified electric vehicle charger. Using uncertified charger may cause the damage to the vehicle.
- Before charging the battery, turn the vehicle OFF.
- When the vehicle is switched OFF while charging, the cooling fan inside the motor compartment may automatically operate. Do not touch the cooling fan while charging.
- Be careful not to drop the charging connector. The charging connector can be damaged.

How to Check the Symbol on the Charging Label



You can find the charging label when opening the charging door.

Charging label



1. Warning for high voltage
2. Caution
3. Charging voltage and current

WARNING

Risk of failure, fire, injury, etc., are expected when using the charging connector with unmatched symbol.

Disconnecting Charging Connector in Emergency

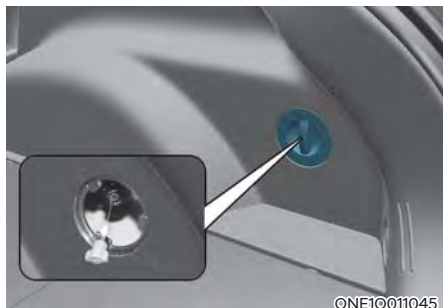

If the charging connector does not disconnect from the charging inlet due to battery discharge and failure of electric wires, open the liftgate and slightly pull the emergency cable in the cargo area. The charging connector will be disconnected from the charging inlet.

AC Charge

■ AC Charger



Actual charger image and charging method may vary in accordance with the charger manufacturer.

How to Connect AC Charger

1. Depress the brake pedal and apply the parking brake.
2. Turn OFF all switches, shift to P (Park), and turn OFF the vehicle. If charging is initiated without the gear in P (Park), the charging will start after the gear is automatically shifted to P (Park).

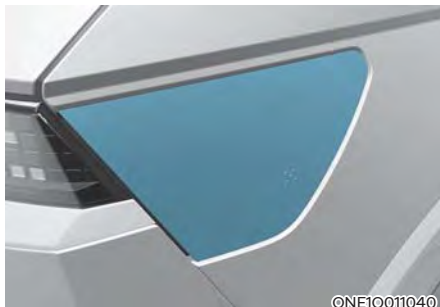

3. Open the charging door.

For more details, refer to 'Electric charging door' in this chapter.

i Information

If you cannot open the charging door due to freezing weather, tap lightly or remove any ice near the charging door. Do not try to forcibly open the charging door.

4. Check if there is dust on the charging connector and charging inlet.
5. Hold the charging connector handle and connect it to the vehicle charging inlet. Push the connector all the way in. If the charging connector and charging terminal are not connected properly, this may cause a fire.

i Information

Locking Charging Cable

Select 'Settings → ECO Vehicle → **Charging Connector Locking Mode**' in the infotainment system menu. The charging connector is locked in the inlet at a different period according to which mode is selected.

- **Always mode** : The connector locks when the charging connector is plugged into the charging inlet.
- **While charging mode** : The connector locks when charging starts.

For more details, refer to 'Locking Charging Cable' in this chapter.

6. Connect the charging plug to the electric outlet at a AC charging station to start charging.

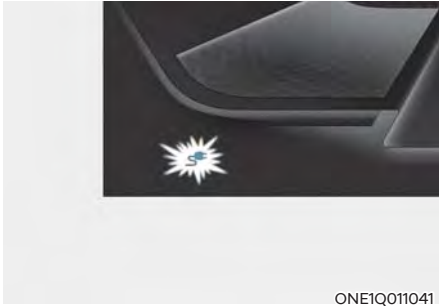

ONE1Q011041

7. Check if the charging connector indicator light (☀) of the high voltage battery on the instrument cluster is turned ON. Charging is not active when the charging connector indicator light (☀) is OFF.

When the charging connector and charging plug are not connected properly, reconnect the charging cable to charge.

i Information

- Even though charging is possible with the Start/Stop button in the ON/START position, for your safety, start charging when the Start/Stop button is in the OFF position and the vehicle shifted to P (Park). After charging has started, you can use electrical components such as the radio by pressing the Start/Stop button to the ACC or ON position.
- During AC charging, the radio reception may be poor.
- During charging, the gear cannot be shifted from P (Park) to any other gear.



ONE1Q011058E

8. After charging has started, the estimated charging time is displayed on the instrument cluster for about 1 minute.

If you open the driver seat door while charging, the estimated charging time is also displayed on the instrument cluster for about 1 minute. When scheduled charging or scheduled air conditioning/heating is set, the estimated charging time is displayed as "--".

i Information

Depending on the condition and durability of the high voltage battery, charger specifications, and ambient temperature, the time required for charging the battery may vary.

Checking Charging Status

When charging the high voltage battery, the charge level can be checked from outside the vehicle.

For more details, refer to ‘Charge Indicator Lamp for Electric Vehicle’ in this chapter.

How to Disconnect AC Charger

■ AC Charger



1. When charging is complete, remove the charging plug from the electrical outlet of the AC charging station.



2. Hold the charging connector handle and pull it out.

i Information

To prevent charging cable theft, the charging connector cannot be disconnected from the inlet when the doors are locked or the charging connector is in the LOCK mode. Unlock all doors to disconnect the charging connector from the inlet.

However, if the vehicle is in the charging connector AUTO mode, the charging connector automatically unlocks from the inlet when charging is completed.

If you attempt to disconnect the charging connector without pressing the release button, the connector and the inlet may be damaged. For more details, refer to “Charging Connector AUTO/ LOCK Mode” in this chapter.

If the release button does not work even after the all doors are unlocked, pull the emergency lift cable in the motor room and press the release button in the connector to disconnect it from the vehicle. If the release button still does not work, consult an authorized HYUNDAI dealer.

3. Make sure to completely close the charging door.
4. Close the protection caps of the charging connector and the charging plug to protect them from foreign substances.
5. If the personal charging connector is used, store the connector in the cable compartment.

DC Charge

■ DC Charger



You can charge at high speeds at public charging stations. Refer to the respective company's manual that is provided for each DC charger type.

Battery performance and durability can deteriorate if the DC charger is used constantly.

Use of DC charge should be minimized in order to help prolong high voltage battery life.

Actual charger image and charging method may vary in accordance with the charger manufacturer.

i Information

If you use a DC charger when the vehicle is already fully charged, some DC chargers will send out an error message. When the vehicle is fully charged, do not charge the vehicle.

How to Connect DC Charger

1. Depress the brake pedal and apply the parking brake.
2. Turn OFF all switches, shift to P (Park), and turn OFF the vehicle.



3. Open the charging door.

For more details, refer to 'Electric Charging Door' in this chapter.

i Information

If you cannot open the charging door due to freezing weather, tap lightly or remove any ice near the charging door. Do not try to forcibly open the charging door.

4. Check whether there is dust or foreign substances inside the charging connector and charging inlet.
5. Hold the charging connector handle and connect it to the vehicle charging inlet. Push the connector all the way in. If the charging connector and charging terminal are not connected properly, this may cause a fire.

Refer to the manual for each type of DC charger for how to charge and remove the charger.



ONE1Q011041

6. Check if the charging connector indicator light (☀) of the high voltage battery on the instrument cluster is turned ON. Charging connector is not active when the charging connector indicator light (☀) is OFF.

When the charging connector is not connected properly, reconnect the charging cable to charge it again.

During cold weather, DC charging may not be available to prevent high voltage battery degradation.

i Information

To control the temperature of the high voltage battery while charging or when the battery temperature is high, the air conditioner is used to cool down the battery. It may generate noise or vibration from operation of the air conditioner compressor and cooling fan, but it is a normal condition when charging the high voltage battery. Also, the air conditioner's performance may be degraded due to operation of the cooling system to charge the high voltage battery. This is a normal condition.

i Information

Even though charging is possible with the Start/Stop button in the ON/START position, for your safety, start charging when the Start/Stop button is in the OFF position and the vehicle shifted to P (Park). After charging has started, you can use electrical components such as the radio by pressing the Start/Stop button to the ACC or ON position.

During charging, the gear cannot be shifted from P (Park) to any other gear.



ONE1Q011059E

7. After charging has started, the estimated charging time is displayed on the instrument cluster for about 1 minute.

If you open the driver seat door while charging, the estimated charging time is also displayed on the instrument cluster for about 1 minute.

i Information

- Depending on the condition and durability of the high voltage battery, charger specifications, and ambient temperature, the time required for charging the battery may vary.
- In rare cases, you might hear high frequency noise (very little beep sound) outside the vehicle when charging with 400V fast charger that is deteriorated or has long communication delay.

The high frequency noise can be generated only when the vehicle tries to reduce its own electromagnetic waves to keep fast charging as possible.

Do not worry about this little beep noise, because it is the intentional operation of the car that does not affect any charging performance or the vehicle itself at all.

Checking Charging Status

When charging the high voltage battery, the charge level can be checked from outside the vehicle.

For more details, refer to 'Charge Indicator Lamp for Electric Vehicle' in this chapter.

How to Disconnect DC Charger

1. Remove the charging connector when DC charging is completed, or after you stop charging using the DC charger. Refer to each respective DC charger manual for details about how to disconnect the charging connector.
2. Make sure to completely close the charging door.

Portable Charge (Type A)



- (1) Code and Plug (Code set)
- (2) Control Box
- (3) Charging Cable and Charging Connector

Portable Charge can be used when AC Charge or DC Charge is not available by using household electricity.

How to Set the Charge Level of the Portable Charger

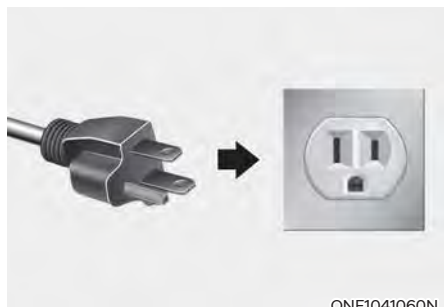

1. Check the rated current of the electric outlet prior to connecting the plug to the outlet.
2. Connect the plug to a household electric outlet.
3. Check the display window on the control box.



4. Press the button (1) on the front of the control box for 2 to 8 seconds to adjust the charge level. (Refer to charging cable type and example for setting the charge level.)
5. The charge level on the display window of the control box changes every time you press the button (1).
6. When setting the charge level is complete, start charging according to the portable charge instructions.

* Example for setting the ICCB charge level

The example is only for reference and may vary according to the surrounding environment.

Outlet current	ICCB charge level	Control box display window
14-16A	12A	
13-12A	10A	
11-10A	8A	
9-8A	6A	

ONX4EPHQ011007L

 **CAUTION**

Please make sure that charge level selection matches the capacity of your circuit breaker to avoid blown fuse.

How to Connect Portable Charger (ICCB: In-Cable Control Box)

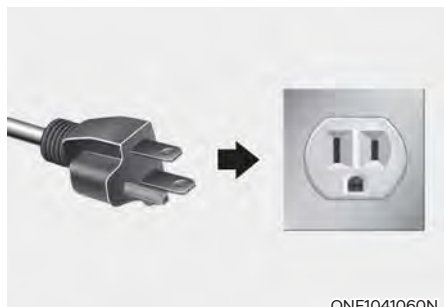

1. Connect the plug to a household electric outlet.



2. Check if the power lamp (green) illuminates on the control box.
3. Depress the brake pedal and apply the parking brake.
4. Turn OFF all switches, shift to P (Park), and turn OFF the vehicle.

If charging is initiated without the gear in P (Park), the charging will start after the gear is automatically shifted to P (Park).

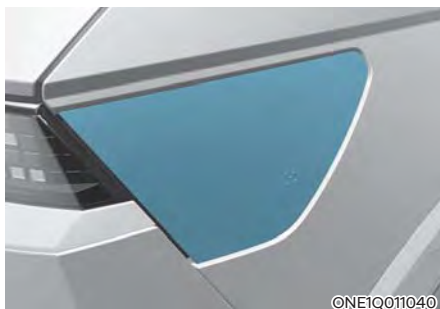

5. Open the charging door.

For more details, refer to 'Electric charging door' in this chapter.

i Information

If you cannot open the charging door due to freezing weather, tap lightly or remove any ice near the charging door. Do not try to forcibly open the charging door.

6. Open the protection caps of the charging connector and the charging plug. Check if there are any foreign substances or dust.
7. Hold the charging connector handle and connect it to the vehicle charging inlet. Push the connector all the way in. If the charging connector and charging terminal are not connected properly, this may cause a fire.

i Information

Locking Charging Cable

Select 'Settings → ECO Vehicle → Charging Connector Locking Mode' in the infotainment. The charging connector is locked in the inlet at a different period according to which mode is selected.

- **Always mode** : The connector locks when the charging connector is plugged into the charging inlet.
- **While charging mode** : The connector locks when charging starts.

For more details, refer to “Locking Charging Cable” in this chapter.

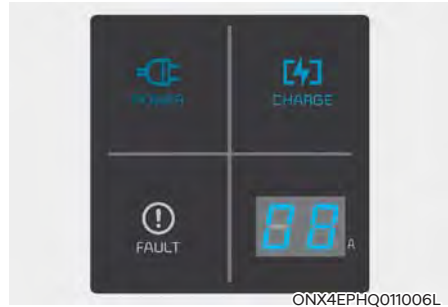

ONX4EPHQ011006L

8. Charging starts automatically (charging lamp illuminates).

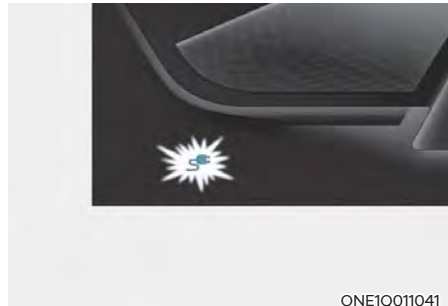

ONE1Q011041

9. Check if the charging indicator light (☛) of the high voltage battery in the instrument cluster is turned ON. Charging is not active when the charging indicator light (☛) is OFF. When the charging connector is not connected properly, reconnect the charging cable to charge it again.

i Information

To control the temperature of the high voltage battery while charging, the air conditioner is used to cool down the battery. It may generate noise or vibration from operation of the air conditioner compressor and cooling fan, but it is a normal condition when charging the high voltage battery. Also, the air conditioner's performance may be degraded due to operation of the cooling system to charge the high voltage battery. This is a normal condition.

i Information

Even though charging is possible with the Start/Stop button in the ON/START position, for your safety, start charging when the Start/Stop button is in the OFF position and the vehicle shifted to P (Park). After charging has started, you can use electrical components such as the radio by pressing the Start/Stop button to the START or ON position.

During charging, the gear cannot be shifted from P (Park) to any other gear.



10. After charging has started, the estimated charging time is displayed on the instrument cluster for about 1 minute.

If you open the driver seat door while charging, the estimated charging time is also displayed on the instrument cluster for about 1 minute. When scheduled charging or scheduled air conditioner/heater is set, the estimated charging time is displayed as "--".

i Information

Depending on the condition and durability of the high voltage battery, charger specifications, and ambient temperature, the time required for charging the battery may vary.

Checking Charging Status

When charging the high voltage battery, the charge level can be checked from outside the vehicle.



For more details, refer to 'Charge Indicator Lamp for Electric Vehicle' in this chapter.

Charging Status Indicator Lamp for Portable Charger





■ Control Box



ONX4EPHQ011008L

Indicator		Details
POWER		On : Power on
CHARGE		On : Charge Blink : Current limit due to high plug temperature or high internal temperature
FAULT		Blink : Charging interrupted

Indicator		Details		
Error code		On : Error while charging/ Error during self-diagnosis		
		Error code	Item	Cause
		E1	Control Pilot communication	Vehicle communication error
		E2	Leakage	Current leakage
		E3		Charger error
		E4	Plug temperature	Plug overtemperature warning
		E5		Plug temperature failure
		E6		Charger error
		E7	Overcurrent	Charging overcurrent warning
		E8	Internal temperature	Charger overheating
		E9		Charger error
		F1	Relay fusion	Charger error
		F2	Ground Monitoring/ Interrupt	Poor grounding of outlet
		F3	Switched mode power supply power failure	Switched mode power supply error (voltage failure)
		F4		Switched mode power supply error (abnormal voltage)
		F5	Control Pilot voltage error	Control Pilot (-) voltage error
		F6		Control Pilot (+) voltage error
F7	Temperature sensor error	Plug temperature sensor error		
F8		PCB internal temperature sensor error		

Indicator	Details	
	12 A	
	10 A	
	8 A	
	6 A	
CHARGE LEVEL	<p data-bbox="194 651 666 751">The charging current changes whenever the button (1) is pressed for less than 1 sec with the charger plugged into an electrical outlet but not the vehicle.</p> <div data-bbox="676 564 987 831"> <p data-bbox="679 564 852 587">* The control box</p>  <p data-bbox="826 831 978 847">ONX4EPHQ011024L</p> </div>	

Status / Diagnosis / Countermeasure



- Charging connector plugged into vehicle (POWER Green ON)
- Plug connected to an electric outlet (POWER Green ON)



While charging

- Charge indicator (POWER Green ON / CHARGE Blue ON)
- Charging current



Before plugging charging connector into vehicle (POWER Green ON, FAULT Red blink)

- Abnormal temperature
 - ICCB (In-Cable Control Box) failure
- Contact an authorized HYUNDAI dealer.

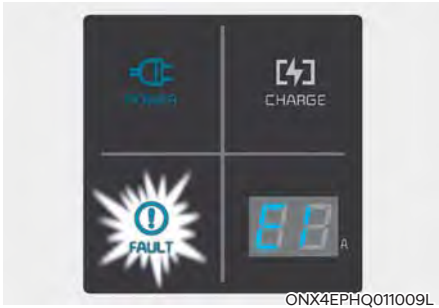

Plugged into vehicle (POWER Green ON, FAULT Red Blink)

- Diagnostic device failure
- Current leakage
- Abnormal temperature

Contact an authorized HYUNDAI dealer.



Power saving mode

- 7-segment display is turned off if there is no status change for more than 1 minute.



- Leakage current failure (POWER Green ON, FAULT Red Blink)
- After disconnecting and reconnecting the power plug, press and release the button for 2 seconds or longer to clear the error.

Contact an authorized HYUNDAI dealer.

How to Disconnect Portable Charger (ICCB: In-Cable Control Box)



1. Hold the charging connector handle and pull it out.

i Information

To prevent charging cable theft, the charging connector cannot be disconnected from the inlet when the doors are locked or the charging connector is in the LOCK mode. Unlock all doors to disconnect the charging connector from the inlet.

However, if the vehicle is in the charging connector AUTO mode, the charging connector automatically unlocks from the inlet when charging is completed.

If you attempt to disconnect the charging connector without pressing the release button, the connector and the inlet may be damaged.

For more details, refer to “Charging Connector AUTO/ LOCK Mode” in this chapter.

If the release button does not work even after the all doors are unlocked, pull the emergency lift cable in the motor room and press the release button in the connector to disconnect it from the vehicle. If the release button still does not work, consult an authorized HYUNDAI dealer.

2. Make sure to completely close the charging door.

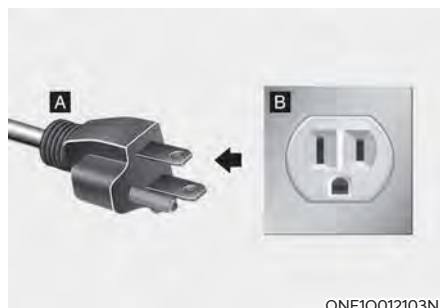

[A]: Plug, [B]: Electric Outlet

3. Disconnect the plug from the household electric outlet. Do not pull the cable when disconnecting the plug.
4. Close the protection caps of the charging connector and the charging plug to protect them from foreign substances.
5. If the personal charging connector is used, store the connector in the cable compartment.

Precautions for Portable Charger (ICCB: In-Cable Control Box)

- Use the portable charger that is certified by HYUNDAI Motors.
- Do not try to repair, disassemble, or adjust the portable charger.
- Do not use an extension cord or adapter.
- Stop using immediately when failure occurs.
- Do not touch the plug and charging connector with wet hands.
- Do not touch the terminal part of the AC charging connector and the AC charging inlet on the vehicle.
- Do not connect the charging connector to voltage that does not comply with regulations.
- Do not use the portable charger if it is worn out, exposed, or there exists any type of damage on the portable charger.
- If the ICCB case and AC charging connector is damaged, cracked, or the wires are exposed in any way, do not use the portable charger.
- Do not let children operate or touch the portable charger.
- Keep the control box free of water.
- Keep the normal charging connector or plug terminal free of foreign substances.
- Do not step on the cable or cord. Do not pull the cable or cord and do not twist or bend it.
- Do not charge when there is lightning.
- Do not drop the control box or place a heavy object on the control box.
- Do not place an object that can generate high temperatures near the charger when charging.
- Charging with the worn out or damaged household electric outlet can result in a risk of electric shock. If you have doubts about the condition of a household electric outlet, have it checked by a licensed electrician.
- Stop using the portable charger immediately if the household electric outlet or any components is overheated or you notice burnt odors.

Portable Charge (Type B)

■ Portable Charger

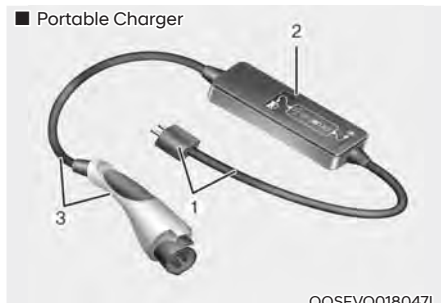

- (1) Code and Plug (Code set)
- (2) Control Box
- (3) Charging Cable and Charging Connector

Portable Charge can be used when AC Charge or DC Charge is not available by using household electricity.

How to set the charging rate of the portable charger

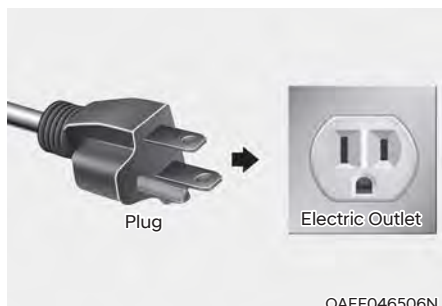

Charging an electric vehicle at home can stress the household electrical system more than a typical household appliance. Most modern residential electrical circuits are rated at 15 or 20 amps. The EV portable charger is rated to supply a 12A continuous load. To avoid tripping a fuse or breaker in the household, the portable charger charging rate can be reduced. Follow the steps below to set the charging rate of the portable charger.

1. Check the current output of the electrical outlet prior to connecting the portable charger in order to determine the permissible charging rate.
2. Connect the plug to a household electric outlet.
3. Check the LED display on the portable charger controller. The indicator 8A, 10A or 12A will be displayed.



4. The charging rate (amps) can be adjusted on the portable charger controller. Press the button (1) on the back of the controller.
5. The charging rate (12A, 10A, 8A) on the LED display changes each time you press the button. Refer to the table to adjust the charging rate based on the electrical outlet current output.
6. When the charging rate is set, follow the procedure in the next section to connect your vehicle.

* Example for setting the ICCB charge level

The example is only for reference and may vary according to the surrounding environment.

Outlet current	ICCB charge level	Control box display window
14-16A	12A	
13-12A	10A	
11-10A	8A	

OOSEVQ018055

 **CAUTION**

Please make sure that charge level selection matches the capacity of your circuit breaker to avoid blown fuse.

How to Connect Portable Charger (ICCB: In-Cable Control Box)

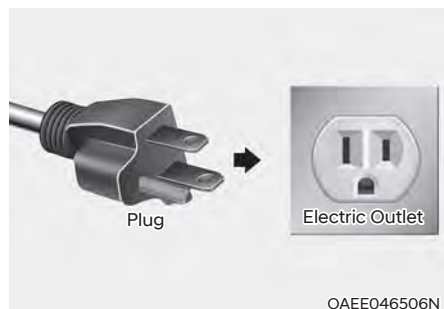

1. Connect the plug to a household electric outlet.



2. Check if the power lamp (green) illuminates on the controller.
3. Depress the brake pedal and apply the electronic parking brake.
4. Turn OFF all switches, shift to P (Park), and turn OFF the vehicle.

i Information

If charging is initiated without the gear in P (Park), charging will start only after the gear is automatically shifted to P (Park).

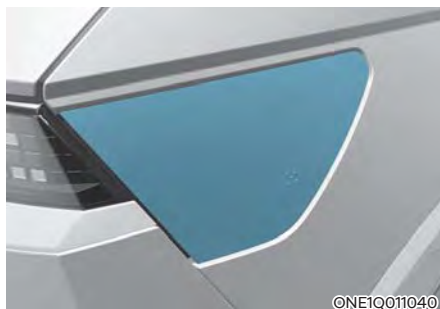

5. Open the charging door.

For more details, refer to 'Electric charging door' in this chapter.

i Information

If you cannot open the charging door due to freezing weather tap lightly or remove any ice near the charging door. Do not try to forcibly open the charging door.

6. Open the protection caps of the charging connector and the charging plug. Check if there are any foreign substances or dust.
7. Hold the charging connector handle and connect it to the vehicle charging inlet. Push the connector all the way in. If the charging connector and charging terminal are not connected properly, this may cause a fire.

i Information

Locking Charging Cable

Select 'Settings → ECO Vehicle → Charging Connector Locking Mode' in the infotainment. The charging connector is locked in the inlet at a different period according to which mode is selected.

- **Always mode** : The connector locks when the charging connector is plugged into the charging inlet.
- **While charging mode** : The connector locks when charging starts.

For more details, refer to “Locking Charging Cable” in this chapter.



OOSEVQ018057

8. Charging starts automatically (charging lamp blinks).

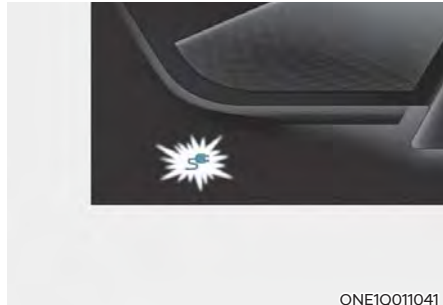

ONE1Q011041

9. Check if the charging indicator light (☀️) of the high voltage battery in the instrument cluster is turned ON. Charging is not active when the charging indicator light (☀️) is OFF. When the charging connector is not connected properly, reconnect the charging cable to charge it again.

i Information

To control the temperature of the high voltage battery while charging or when the battery temperature is high, the air conditioner is used to cool down the battery. It may generate noise or vibration from operation of the air conditioner compressor and cooling fan, but it is a normal condition when charging the high voltage battery. Also, the air conditioner's performance may be degraded due to operation of the cooling system to charge the high voltage battery. This is a normal condition.

i Information

Even though charging is possible with the Start/Stop button in the ON/START position, for your safety, start charging when the Start/Stop button is in the OFF position and the vehicle shifted to P (Park). After charging has started, you can use electrical components such as the radio by pressing the Start/Stop button to the START or ON position.

During charging, the gear cannot be shifted from P (Park) to any other gear.



ONE1Q011058E

10. After charging has started, the estimated charging time is displayed on the instrument cluster for about 1 minute.

If you open the driver seat door while charging, the estimated charging time is also displayed on the instrument cluster for about 1 minute. When scheduled charging or scheduled air conditioner/heater is set, the estimated charging time is displayed as "--".

i Information











Depending on the condition and durability of the high voltage battery, charger specifications, and ambient temperature, the time required for charging the battery may vary.

Checking Charging Status





When charging the high voltage battery, the charge level can be checked from outside the vehicle.

For more details, refer to 'Charge Indicator Lamp for Electric Vehicle' in this chapter.





Charging Status Indicator Lamp for Portable Charger

Control Box		Indicator	Details
	PLUG	 (Green)	On : Power on Blink : Plug temperature sensor failure
		 (Red)	On : Plug high temperature protection Blink : Plug high temperature warning
		 POWER	On : Power on
	CHARGE LEVEL	 CHARGE	Blink : Charging in power saving mode, only the CHARGE indicator is illuminated.
		 FAULT	Blink : Charging interrupted
		12A 10A 8A	The charging current changes (3 level) whenever the button (1) is pressed for 1 sec with the charger plugged into an electrical outlet but not the vehicle. * Back of the control box 
	VEHICLE	 (Green)	Charging connector plugged
		 (Blue)	Charging
		 (Red)	Blink : Charging impossible

Charging Status Indicator Lamp for Portable Charger

NO	Control Box	Status / Diagnosis / Countermeasure	NO	Control Box	Status / Diagnosis / Countermeasure
1		<ul style="list-style-type: none"> • Charging connector plugged into vehicle (Green ON) • Plug temperature sensor failure (Green blink) • Plug high temperature protection (Red blink) • Plug high temperature warning (Red ON) <p>Contact an authorized HYUNDAI dealer.</p>	2		<p>- Charging connector plugged into vehicle (Green ON)</p>
3		<p>- While charging</p> <ul style="list-style-type: none"> • Charge indicator (Green blink) • Vehicle indicator (Blue ON) 	4		<p>- Before plugging charging connector into vehicle (Red blink)</p> <ul style="list-style-type: none"> • Abnormal temperature • ICCB (In-Cable Control Box) failure <p>Contact an authorized HYUNDAI dealer.</p>

Charging Status Indicator Lamp for Portable Charger

NO	Control Box	Status / Diagnosis / Countermeasure	NO	Control Box	Status / Diagnosis / Countermeasure
5		<ul style="list-style-type: none"> - Plugged into vehicle (Red blink) • Diagnostic device failure • Current leakage • Abnormal temperature <p>Contact an authorized HYUNDAI dealer.</p>	6		<ul style="list-style-type: none"> - After plugging charging connector into vehicle (Red blink) • Communication failure <p>Contact an authorized HYUNDAI dealer.</p>
7		<ul style="list-style-type: none"> • Plug temperature sensor failure (Green blink) • Plug high temperature protection (Red blink) • Plug high temperature warning (Red ON) <p>Contact an authorized HYUNDAI dealer.</p>	8		<ul style="list-style-type: none"> - Power saving mode • 3 minutes after charging starts (Green blink)

How to Disconnect Portable Charger (ICCB: In-Cable Control Box)

1. Hold the charging connector handle and pull it out.

i Information

To prevent charging cable theft, the charging connector cannot be disconnected from the inlet when the doors are locked or the charging connector is in the LOCK mode. Unlock all doors to disconnect the charging connector from the inlet.

However, if the vehicle is in the charging connector AUTO mode, the charging connector automatically unlocks from the inlet when charging is completed.

If the charging connector is disconnected while the release button is not pressed, the connector and the inlet may be damaged.

For more details, refer to “Charging Connector AUTO/ LOCK Mode” in this chapter.

If the release button does not work even after the all doors are unlocked, pull the emergency lift cable in the motor room and press the release button in the connector to disconnect it from the vehicle. If the release button still does not work, consult an authorized HYUNDAI dealer.

2. Make sure to completely close the charging door.

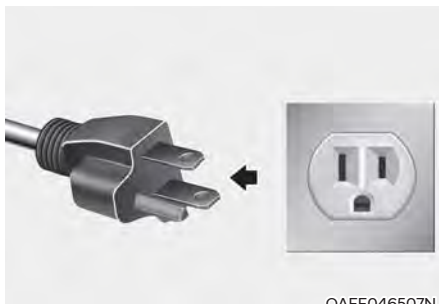

3. Disconnect the plug from the household electric outlet. Do not pull the cable when disconnecting the plug.
4. Close the protection caps of the charging connector and the charging plug to protect them from foreign substances.
5. If the personal charging connector is used, store the connector in the cable compartment.

Precautions When Using the Portable Charger

- Use the portable charger that is certified by HYUNDAI.
 - Do not try to repair, disassemble, or adjust the portable charger.
 - If an extension cord is used it must be rated for heavy duty of at least 15A. Keep as short as possible.
 - Stop using immediately when failure occurs.
 - Do not touch the plug and charging connector with wet hands.
 - Do not touch the terminal part of the AC charging connector and the AC charging port on the vehicle.
 - Do not connect the charging connector to voltage that does not comply with regulations.
 - Do not use the portable charger if it is worn, if any of the wiring is exposed, or if there are any signs of damage to the cable or connector.
 - Do not let children operate or touch the portable charger.
 - Do not let the controller to be in contact with water.
 - Keep the normal charging connector or plug terminal free of foreign substances.
 - Do not step on the cable or cord. Do not pull the cable or cord and do not twist or bend it.
 - Do not attempt to charge the vehicle outside during inclement weather when there is the possibility of lightning.
 - Do not drop the controller or place heavy objects on the equipment.
 - Do not place an object that can generate high temperatures near the charger when charging.
- Before plugging into any electrical outlet, have a qualified electrician inspect and verify the household electrical system for heavy duty service at a 12 amp continuous load.
 - Stop using the portable charger immediately if the household electric outlet or any components becomes overheated or has a burning smell.

CHARGING THE ELECTRIC VEHICLE (ABRUPT STOP)

Action to be taken when charging stops abruptly

When the high voltage battery does not charge, check the followings:

1. Check the charging setting for the vehicle. Refer to “Charge Management”, in this chapter (for example, When scheduled charging is set, charging is not initiated immediately when the AC charger or portable charger (ICCB: In-Cable Control Box) is connected.)
2. Check the operation status of AC charger, portable charger and DC charger.
(Charging Status Indicator Lamp for Portable Charger, refer to “Checking Charging Status” for trickle charge in this chapter.)
- * Actual method for indicating the charging status may vary in accordance with the charger manufacturer.
3. When the vehicle does not charge and a warning message appears on the cluster, check the corresponding message. Refer to “LCD Display Messages”, in this chapter.
4. If the vehicle is properly charged when charged with another normally working charger, contact the charger manufacturer.
5. If the vehicle does not charge when charged with another normally working charger, contact an authorized HYUNDAI dealer for inspection.
6. If charging fails and the service warning light () is lit in the cluster, contact an authorized HYUNDAI dealer.

DRIVING ELECTRIC VEHICLE

How to Start the Vehicle

1. Holding the smart key, sit in the driver's seat.
2. Fasten the seat belt before starting the vehicle.
3. Make sure to engage the parking brake.
4. Turn OFF all electrical devices.
5. Make sure to depress and hold the brake pedal.
6. While depressing the brake pedal, shift to P (Park).
7. Depress and hold the brake pedal while pressing the Start/Stop button.

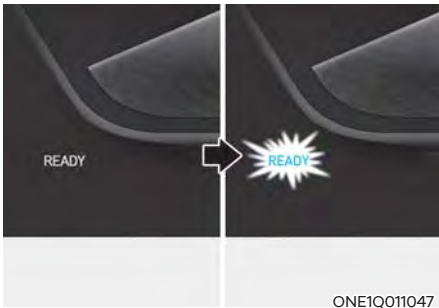

8. When the “READY” indicator is ON, you can drive the vehicle.
When the “READY” indicator is OFF, you cannot drive the vehicle. Start the vehicle again.
9. Depress and hold the brake pedal and shift to the desired position.

10. Release the parking brake and slowly release the brake pedal. Check if the vehicle slowly moves forward, then depress the accelerator pedal.

How to Stop the Vehicle

1. Hold down the brake pedal while the vehicle is parked.
2. While depressing the brake pedal, shift to P (Park).
3. While depressing the brake pedal, engage the parking brake.
4. While depressing the brake pedal, press the Start/Stop button and turn off the vehicle.



5. Check if the “READY” indicator is turned OFF on the instrument cluster.
When the “READY” indicator is ON and the gear is in a position other than P (Park), the driver can accidentally depress the accelerator pedal, causing the vehicle to move unexpectedly.

i Information

While the charging cable is connected, the gear cannot be shift from P (Park) to any other gear for safety reasons.

Virtual Engine Sound System

The Virtual Engine Sound System generates engine sound for pedestrians to hear vehicle sound because there is no sound while the Electric Vehicle (EV) is operating.

- If the vehicle is in the ready (**READY**) mode and the gear is not in P (Park), the VESS will be operated.
- When the gear is shifted to R (Reverse), an additional warning sound will be heard.



CAUTION

- **The vehicle is much quieter while driving than a conventional gasoline-powered vehicle. Be aware of your surroundings and always drive safely.**
- **After you park the vehicle or while you are waiting at a traffic light, check whether there are children or obstacles around the vehicle.**
- **Check if there is something behind the vehicle when driving in reverse. Pedestrians may not hear the sound of the vehicle.**

Distance to Empty



The distance to empty is displayed differently according to the selected drive mode in the Drive Mode Integrated Control System.

For more information, refer to “Drive Mode Integrated Control System” in chapter 6.

When destination is not set

- On average, a vehicle can drive about 200 miles (320 km) (Standard type) / 300 miles (400 km) (Extended type).
- Under certain circumstances where the air conditioner/heater is ON, the distance to empty is impacted, resulting in a possible distance range from 106 ~ 286 miles (170 ~ 460 km) (Standard type) / 130 ~ 300 miles (210 ~ 570 km) (Extended type). When using the heater during cold weather or driving at high speed, the high voltage battery consumes a lot more electricity. This may reduce the distance to empty significantly.
- After '0 km' has been displayed, the vehicle can drive an additional 2~5 miles (3~8 km) depending on driving speed, heater/air conditioner, weather, driving style, and other factors.

- Distance to empty that is displayed on the instrument cluster after completing a recharge may vary significantly depending on previous operating patterns.

When previous driving patterns include high speed driving, resulting in the high voltage battery using more electricity than usual, the estimated distance to empty is reduced. When the high voltage battery uses little electricity in ECO mode, the estimated distance to empty increases.

- Distance to empty may depend on many factors such as the charge amount of the high voltage battery, weather, temperature, durability of the battery, geographical features, and driving style. When the ambient temperature is low such as in winter, the actual driving distance may reduce due to degradation of the battery.
- Natural degradation may occur with the high voltage battery depending on the number of years the vehicle is used. This may reduce the distance to empty.

When destination is set

When the destination is set, the distance to empty may change. The distance to empty is recalculated using the information of the destination. However, the distance to empty may vary significantly based on traffic conditions, driving habits, and condition of the vehicle.

Tips for Improving Distance to Empty

- If you operate the air conditioner / heater too much, the driving battery uses too much electricity. This may reduce the distance to empty. Therefore, it is recommended that you set the cabin temperature to 22°C AUTO. This setting that has been certified by various assessment tests to maintain optimal energy consumption rates while keeping the temperature fresh.
Turn OFF the heater and air conditioner if you do not need them.
- When the heater or air conditioning system is on the energy consumption is reduced if recirculation mode is selected instead of selecting the fresh mode. The fresh mode requires large amount of energy consumption as the outside air has to be re-heated or cooled.
- When using the heater or air conditioning system use the DRIVER ONLY or scheduled air conditioner/ heater function.
- Depress and hold the accelerator pedal to maintain speed and drive economically.
- Gradually depress and release the accelerator pedal when accelerating or decelerating.
- Always maintain specified tire pressures.
- Do not use unnecessary electrical components while driving.
- Do not load unnecessary items in the vehicle.
- Do not mount parts that may increase air resistance.

ECO Driving



ONE1Q011034E

In order to check the ECO driving history, select 'Menu → ECO Driving' on the screen.

Electric energy economy history

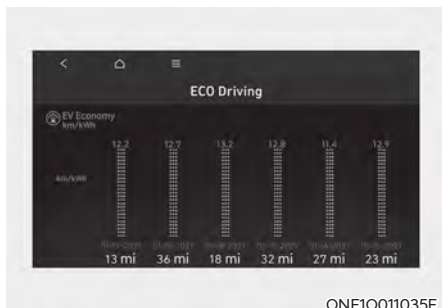

ONE1Q011035E

It is possible to check the history of electric energy economy with the date and distance of previous driving. The icon is displayed on the most efficient electric energy economy record.

Electricity Use

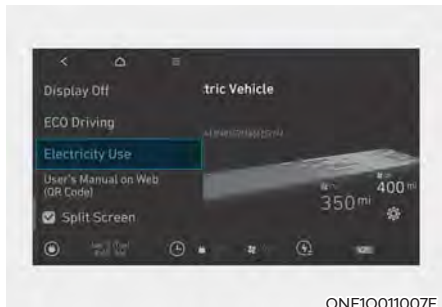

ONE1Q011007E

In order to check the current energy consumption for each system of the vehicle, select 'Menu → Electricity Use' on the screen.

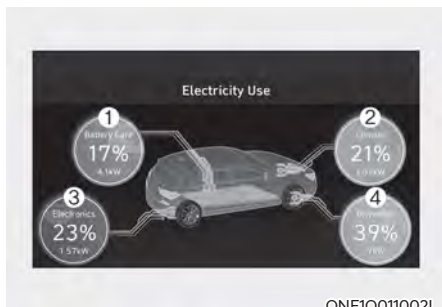

ONE1Q011002L

- 'Battery care' shows the momentary power and energy consumption which are used when:
 - Operating the winter mode to increase the battery temperature during winter to improve the driving performance.
 - Cooling down the battery temperature during summer to prevent over temperature of the battery.
- 'Climate' shows the power and energy consumption which are used by the heater or air conditioner.

3. 'Electronics' shows the power and energy consumption which are used by the vehicle systems including the cluster, infotainment system (speaker and navigation), headlight, vehicle control unit, etc.
4. 'Driving' shows the total power and energy consumption of the driving motor's driving energy and regenerative energy.

Power/Charge Gauge

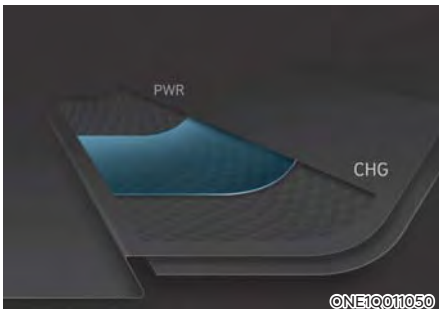

The Power/Charge Gauge shows the energy consumption rate of the vehicle and the charge/discharge status of the regenerative brakes.

- **POWER :**
It shows the energy consumption rate of the vehicle when driving uphill or accelerating. The more electric energy is used, the higher the gauge level.
- **CHARGE :**
It shows the charging status of the battery when it is being charged by the regenerative brakes (decelerating or driving on a downhill road). The more electric energy is charged, the lower the gauge level.

State Of Charge (SOC) Gauge for High Voltage Battery

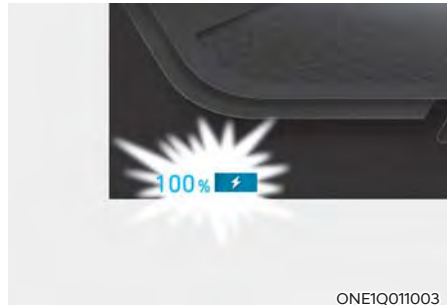

- The SOC gauge shows the charging status of the high voltage battery.
- The low percentage number on the indicator indicates that there is not enough energy in the high voltage battery. 100 % indicates that the driving battery is fully charged.
- When driving on highways or motorways, make sure to check in advance if the driving battery is charged enough.



ONE1Q011011

When the remaining battery is lower than 10 % on the SOC gauge, the warning light (🔋⚡) turns ON to alert you of the battery level.

When the warning light (🔋⚡) turns ON, the vehicle can drive an additional 18 ~ 25 miles (30 ~ 40 km) depending on the driving speed, heater/air conditioner, weather, driving style, and other factors. Charging is required.

NOTICE

When the high voltage battery level is low, the power down indicator light (🔋⚡) illuminates and the vehicle power is limited.

Charge the battery immediately since your vehicle may not be driven, or may roll back on a slope with the indicator light ON.

Aux. Battery Saver+

The Aux. Battery Saver+ is a function that monitors the charging status of the 12 V auxiliary battery.

If the auxiliary battery level is low, the main high voltage battery charges the auxiliary battery.

i Information

- **The Aux. Battery Saver+ activates maximum of 20 minutes. If the Aux. Battery Saver+ function activates more than 10 times consecutively, in the Automatic Mode the function will stop activating, judging that there is a problem with the auxiliary battery. In this case, drive the vehicle for some period of time. The function will start activating if the auxiliary battery returns to normal.**
- **The Aux. Battery Saver+ function cannot prevent battery discharge if the auxiliary battery is damaged, worn out, used as a power supply or unauthorized electronic devices are used.**
- **If the Aux. Battery Saver+ function was activated the high voltage battery level may have decreased.**

 **WARNING**

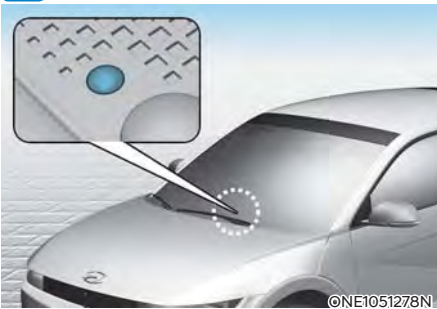

When the function is activating the indicator lamp will illuminate and high voltage electricity will be flowing in the vehicle. Do not touch the high voltage electric wire (orange), connector, and all electric components and devices. This may cause electric shock and lead to injuries. Also, do not modify your vehicle in any way. This may affect your vehicle performance and lead to an accident.

Warning and Indicator Lights (related to electric vehicle)

Ready indicator

READY

This indicator illuminates:

When the vehicle is ready to be driven.

- ON : Normal driving is possible.
- OFF : Normal driving is not possible, or a problem has occurred.
- Blinking : Emergency driving.

When the ready indicator goes OFF or blinks, there is a problem with the system. In this case, have your vehicle inspected by an authorized HYUNDAI dealer.

Service Warning Light



This warning light illuminates:

- When the Start/Stop button is in the ON position.
 - It illuminates for approximately 3 seconds and then goes off.
- When there is a problem with related parts of the electric vehicle control system, such as sensors, etc.

When the warning light illuminates while driving, or does not go OFF after starting the vehicle, have your vehicle inspected by an authorized HYUNDAI dealer.

Power Down Indicator Light

This warning light illuminates:

- When the Start/Stop button is in the ON position.
 - It illuminates for approximately 3 seconds and then goes off.
- When the power is limited for the safety of the high-powered parts of an electric vehicle. The power is limited for the following reasons. (Unless both Service Warning Light and Power Down Indicator Light illuminate at the same time, it is not a failure.)
 - The high voltage battery level is too low or voltage is decreasing
 - The temperature of the high voltage battery is too high or too low
 - The temperature of the motor is high

NOTICE

- **Do not accelerate or start the vehicle suddenly when the power down indicator light is ON.**
- **When the power is limited for the safety of the high-powered parts of an electric vehicle, the power down indicator light illuminates. Your vehicle may not be driven, or may roll back on a slope with the indicator light ON due to the limitation of vehicle power.**

Charging connector Indicator Light

This warning light indicates the connection status of the charging connector. When the charging connector is connected to the vehicle, the green light illuminates for approximately 1 minute.

High Voltage Battery Level Warning Light

This warning light illuminates:

- When the high voltage battery level is low.
- When the warning light turns ON, charge the battery immediately.

Regenerative Brake Warning Light

This warning light illuminates:

When the regenerative brake does not operate and the brake does not perform well. This causes the Brake Warning light (red) and Regenerative Brake Warning Light (yellow) to illuminate simultaneously.

In this case, drive safely and have your vehicle inspected by an authorized HYUNDAI dealer.

The operation of the brake pedal may be more difficult than normal and the braking distance can increase.

LCD Display Messages

Shift to P to charge



This message is displayed if you connect the charging cable without the gear in the P (Park) position.

Shift to P (Park) before connecting the charging cable.

Remaining time

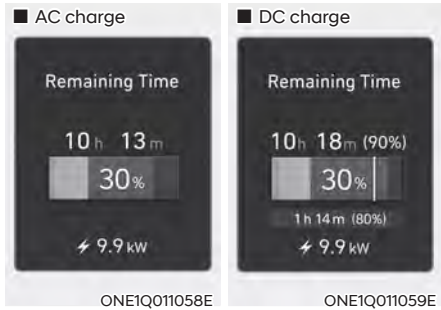

This message displays how much time remains until the battery is charged to the selected target battery charge level.

Unplug vehicle to start



This message is displayed when you start the vehicle without unplugging the charging cable. Unplug the charging cable, and then turn on the vehicle.



This message is displayed when the vehicle is driven with the charging door opened. Close the charging door and then start driving.

Charging Stopped. Check the AC/DC charger

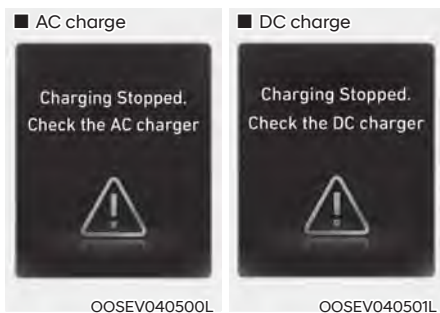

- This warning message is displayed when charging is stopped for the reasons below:
 - There is a problem with the external AC charger or DC charger
 - The external AC charger stopped charging
 - The charging cable is damaged

In this case, check whether there is any problem with the external AC or DC charger and charging cable.

If the same problem occurs when charging the vehicle with a normally operating AC charger or genuine HYUNDAI portable charger, have your vehicle inspected by an authorized HYUNDAI dealer.

Charging Stopped. Check the cable connection

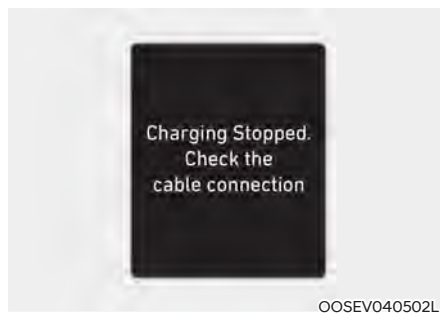

This warning message is displayed when charging is stopped because the charging connector is not correctly connected to the charging inlet.

In this case, separate the charging connector and re-connect it and check whether there is any problem (external damage, foreign substances, etc.) with the charging connector and charging inlet.

If the same problem occurs when charging the vehicle with a replaced charging cable or genuine HYUNDAI portable charger, have your vehicle inspected by an authorized HYUNDAI dealer.

Check regenerative brakes

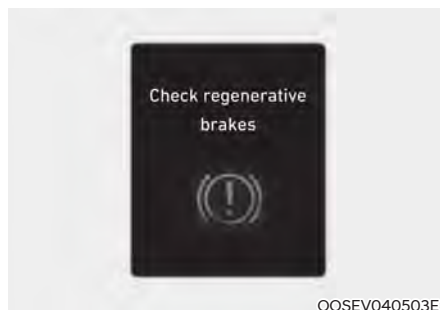

This warning message is displayed when the regenerative brake system does not work properly.

In this case, have the vehicle inspected by an authorized HYUNDAI dealer.

Low EV battery



When the high voltage battery level reaches below approximately 10%, this warning message is displayed. The warning light on the instrument cluster (🔋) will turn ON simultaneously. Charge the high voltage battery immediately.

Charge immediately. Power limited



When the high voltage battery level reaches below approximately 5%, this warning message is displayed. The warning light on the instrument cluster (🔋) and the power down warning light (🚫) will turn on simultaneously. The vehicle's power will be reduced to minimize the energy consumption of the high voltage battery. Charge the battery immediately.

Power limited due to low EV battery temperature. Charge battery

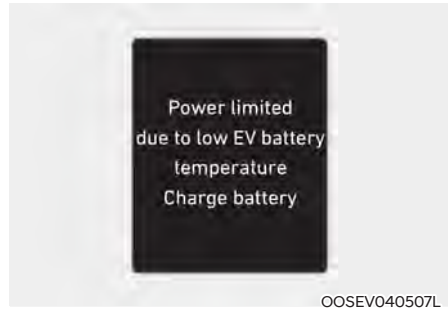

Both warning messages are displayed to protect electric vehicle system when outside temperature is low. If the high voltage battery charging level is low and parked outside in low temperature for a long time, vehicle power could be limited.

Charging the battery before driving helps increase power.

NOTICE

If these warning messages are still displayed even after the ambient temperature has increased, have the vehicle inspected by an authorized HYUNDAI dealer.

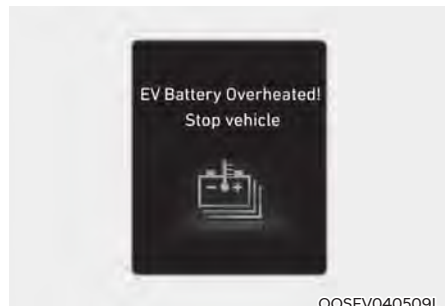
EV Battery Overheated! Stop vehicle

This warning message is displayed to protect battery and electric vehicle system when the high voltage battery temperature is too high.

Turn off the Start/Stop button and stop the vehicle so that the battery temperature decreases.

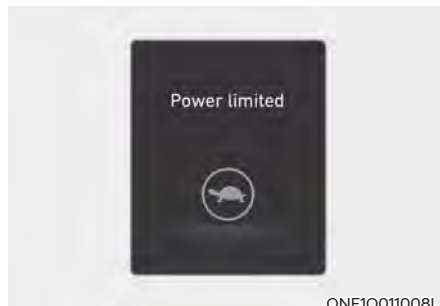
Power limited

This warning message is displayed:

- When the START/STOP button is in the ON position.
 - It illuminates for approximately 3 seconds and then goes off.
- When the power is limited for the safety of the high-powered parts of an electric vehicle. The power is limited for the following reasons. (Unless both Service Warning Light and Power Down Indicator Light illuminate at the same time, it is not a failure.)
 - The high voltage battery level is too low or voltage is decreasing
 - The temperature of the high voltage battery is too high or too low
 - The temperature of the motor is high

NOTICE

- **When this warning message is displayed, do not accelerate or start the vehicle suddenly.**
- **When the power is limited for the safety of the high-powered parts of the electric vehicle, the warning message is displayed. Your vehicle may not be driven, or may roll back on a slope with the warning message displayed due to the limitation of vehicle power.**

Stop vehicle and check power supply



This warning message is displayed when a failure occurs in the power supply system.

In this case, park the vehicle in a safe location and have your vehicle towed to the nearest authorized HYUNDAI dealer and have the vehicle inspected.

Check electric vehicle system



This warning message is displayed when there is a problem with the electric vehicle control system.

Refrain from driving when the warning message is displayed.

In this case, have the vehicle inspected by an authorized HYUNDAI dealer.

Check virtual engine sound system



This message is displayed when there is a problem with the Virtual Engine Sound System (VESS).

In this case, have the vehicle inspected by an authorized HYUNDAI dealer.

SAFETY PRECAUTIONS FOR ELECTRIC VEHICLE

If an Accident Occurs

WARNING

- When a vehicle accident occurs, move the vehicle to a safe place, turn OFF the vehicle and disconnect the high voltage cut-off switch from the auxiliary battery (12V) to prevent high voltage electricity from flowing.
- If electric wires are exposed from inside or outside the vehicle, do not touch the wires.

Also, do not touch the high voltage electric wire (orange), connector, and all electric components and devices. This may cause electric shock and lead to injuries.

WARNING

- When a vehicle accident occurs and the high voltage battery is damaged, harmful gas and electrolytes may leak. Be careful not to touch the leaked liquid.
- When you suspect leakage of inflammable gas and other harmful gases, open the windows and evacuate to a safe location. If any leaked fluid comes in contact with your eyes or skin, immediately clean the affected area thoroughly with tap water or saline solution and have doctors inspect it as soon as possible.

WARNING

- If a small scale fire occurs, use a fire extinguisher (ABC, BC) that is meant for electrical fires. If it is impossible to extinguish the fire in the early stage, maintain a safe distance from the vehicle and immediately call your local fire emergency responders. Also, advise them that an electric vehicle is involved.
- If the fire spreads to the high voltage battery, large amount of water is needed to put out the fire. Using small amount of water or fire extinguishers not meant for electrical fires could cause serious injury or death from electrical shocks.

WARNING

- If you cannot put out the fire immediately, the high voltage battery may explode. Evacuate to a safe place and do not let other people approach the site.
Contact the fire department and notify them of an electric vehicle fire.
- If the vehicle is flooded with water, immediately turn off the vehicle and evacuate to a safe place. Contact the fire department or an authorized HYUNDAI dealer.

 **WARNING**

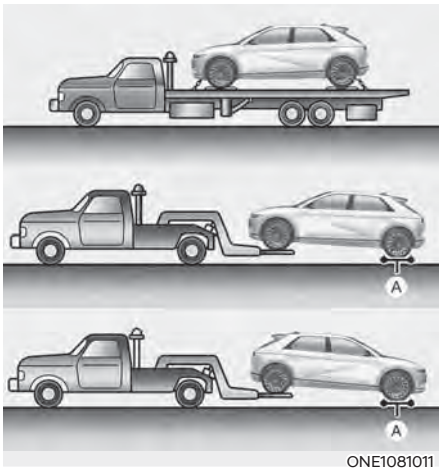

[A] : Dollies

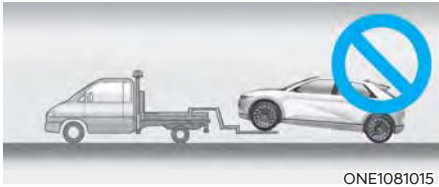

Other Precautions for Electric Vehicle

- When you paint or apply heat treatment to the vehicle as a result of an accident, the performance of the high voltage battery can be reduced.
- If heat treatment is required, contact an authorized HYUNDAI dealer.
- When you clean the motor compartment, do not use high pressure water to wash. This may cause an electric shock due to a discharge in high voltage electricity, or damage the vehicle's electric system.
- Use or install genuine Hyundai part or the equivalent (of the genuine part) specified for your vehicle.

- **If towing is required, lift all four wheels off the ground and tow the vehicle. If you must tow the vehicle using only two wheels, lift the front wheels off the ground and tow the vehicle.**
- **If you tow the vehicle while the rear wheels are touching the ground, the vehicle motor may generate electricity and the motor components may be damaged or a fire may occur.**
- **When a vehicle fire occurs due to the battery, there is a risk of a second fire. Contact the fire department when towing the vehicle.**

High Voltage cut-off Switch

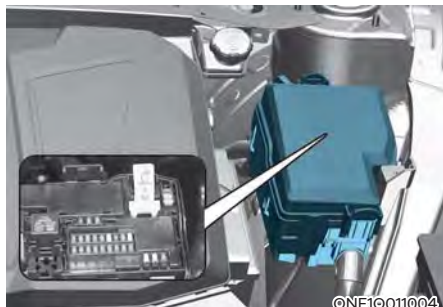

Pull down the yellow lever in the high voltage cut-off switch to shut down high voltage battery.

WARNING

Never disconnect the high voltage cut-off switch except in an emergency situation.

Serious problems may occur, such as the vehicle will not start.

NOTICE

Putting the excessive force to the switch lever while shutting down the high voltage battery may severely damage the high voltage cut-off switch.

2. Vehicle Information, Consumer Information and Reporting Safety Defects

Exterior Overview (I)	2-2
Exterior Overview (II)	2-3
Interior Overview	2-4
Instrument Panel Overview (I)	2-5
Instrument Panel Overview (II)	2-6
Motor Compartment	2-7
Dimensions.....	2-8
Electric Vehicle Specifications.....	2-8
Bulb Wattage.....	2-9
Tires and Wheels.....	2-10
Air Conditioning System.....	2-11
Vehicle Weight and Luggage Volume	2-11
Available Front Trunk Weight	2-11
Recommended Lubricants and Capacities.....	2-12
Vehicle Identification Number (VIN)	2-13
Vehicle Certification Label	2-13
Tire Specification and Pressure Label	2-14
Motor Number	2-14
Air Conditioner Compressor Label	2-15
Refrigerant Label	2-15
Consumer Information	2-16
Reporting Safety Defects	2-17

EXTERIOR OVERVIEW (I)

■ Front view



- | | | | |
|---------------------------|------------|--------------------------------------|------------|
| 1. Hood..... | 5-73 | 6. Front windshield wiper blades ... | 5-99, 9-16 |
| 2. Headlight..... | 9-49 | 7. Windows | 5-63 |
| 3. Tires and wheels..... | 9-22 | 8. Front radar | 7-4 |
| 4. Side view mirror..... | 5-59 | 9. Surround-front view camera | 7-116 |
| 5. Vision/Solar roof..... | 5-67, 5-70 | 10. Charging display lamp | 1-25 |

EXTERIOR OVERVIEW (II)

■ Rear view



The actual shape may differ from the illustration.

ONE1011002N

- | | | | |
|--------------------------------|------|------------------------------------|-------|
| 1. Door..... | 5-30 | 5. Liftgate open/close button..... | 5-77 |
| 2. Electric charging door..... | 5-84 | 6. High mounted stop lamp..... | 9-53 |
| 3. Rear lamp..... | 9-51 | 7. Antenna..... | 5-135 |
| 4. Liftgate..... | 5-75 | 8. Rear view camera..... | 7-113 |

INTERIOR OVERVIEW



The actual shape may differ from the illustration.

ONE1011003N

- | | | | |
|--|------|--|-------|
| 1. Inside door handle..... | 5-34 | 9. ESC (Electronic Stability Control) OFF
button..... | 6-37 |
| 2. Integrated memory system | 5-40 | 10. Power liftgate open/close button | 5-78 |
| 3. Side view mirror control switch..... | 5-60 | 11. AUTO Hold button | 6-32 |
| 4. Side view mirror folding button..... | 5-60 | 12. EPB (Electronic Parking Brake)
switch | 6-27 |
| 5. Central door lock switch | 5-34 | 13. Hood release lever..... | 5-73 |
| 6. Power window switches | 5-63 | 14. Steering wheel tilt/telescopic lever | 5-45 |
| 7. Power window lock button / | 5-65 | 15. Steering wheel..... | 5-44 |
| Electronic child safety lock button..... | 5-37 | 16. Seat..... | 3-3 |
| 8. Instrument panel illumination | 4-5 | 17. Cluster fascia side panel | 5-130 |

INSTRUMENT PANEL OVERVIEW (I)

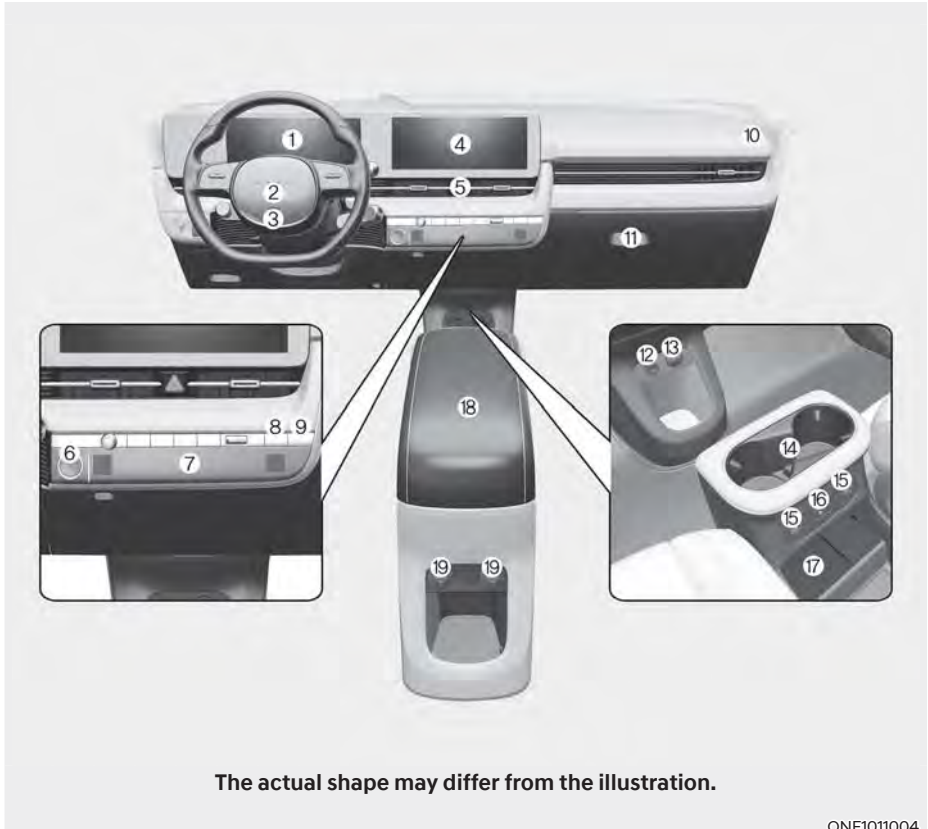

- | | | | |
|---|-------|---------------------------------------|-------|
| 1. Instrument cluster | 4-4 | 11. Glove box | 5-123 |
| 2. Horn..... | 5-46 | 12. USB port..... | 5-135 |
| 3. Driver's front air bag..... | 3-53 | 13. Power outlet..... | 5-125 |
| 4. Infotainment system | 5-136 | 14. Cup holder | 5-124 |
| 5. Hazard warning flasher button..... | 8-2 | 15. USB charger..... | 5-126 |
| 6. Start/Stop button | 6-4 | 16. Wireless charging system | 5-127 |
| 7. Automatic climate control system | 5-102 | 17. Wireless charging system pad..... | 5-127 |
| 8. Parking/View button | 7-114 | 18. Center console..... | 5-122 |
| 9. Parking Safety button..... | 7-134 | 19. Rear seat USB charger | 5-126 |
| 10. Passenger's front air bag | 3-53 | | |

INSTRUMENT PANEL OVERVIEW (II)

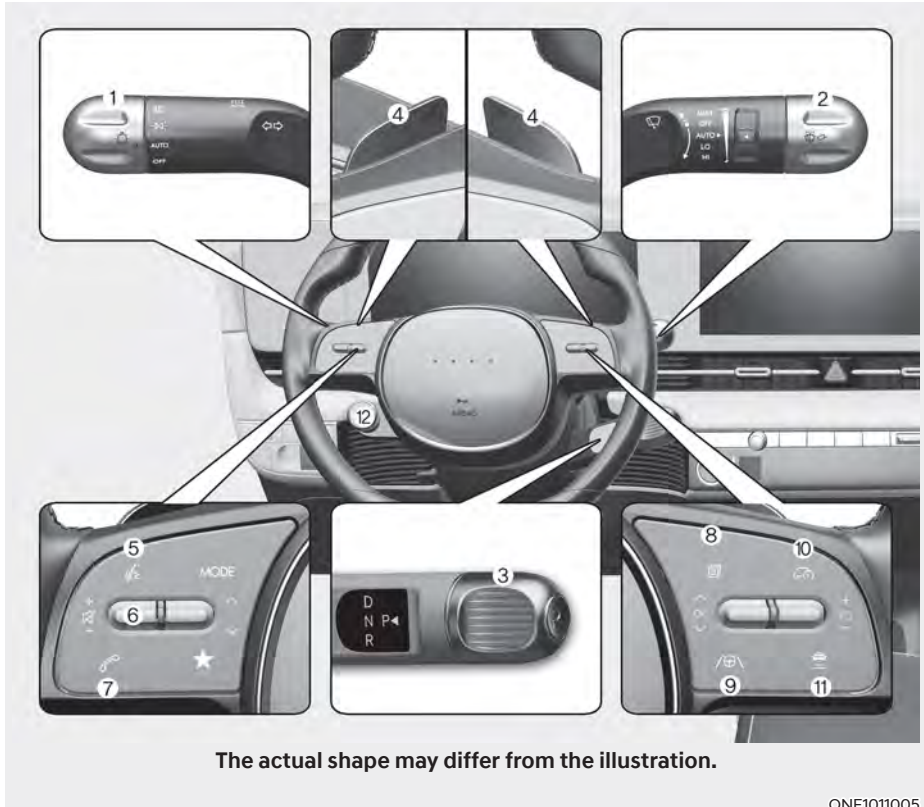

- | | |
|--|---|
| 1. Lighting control lever 5-88 | 7. Bluetooth wireless technology hands-free button..... 5-137 |
| 2. Wiper and washer control lever..... 5-99 | 8. LCD display control 4-29 |
| 3. Rotary shifter(Rotary gear shift dial)..... 6-9 | 9. Lane Driving Assist button..... 7-27, 7-97 |
| 4. Paddle shifter..... 6-16 | 10. Driving Assist button..... 7-71 |
| 5. Voice recognition button 5-137 | 11. Vehicle Distance button..... 7-71 |
| 6. Steering wheel audio controls..... 5-135 | 12. Drive mode button 6-47 |

MOTOR COMPARTMENT

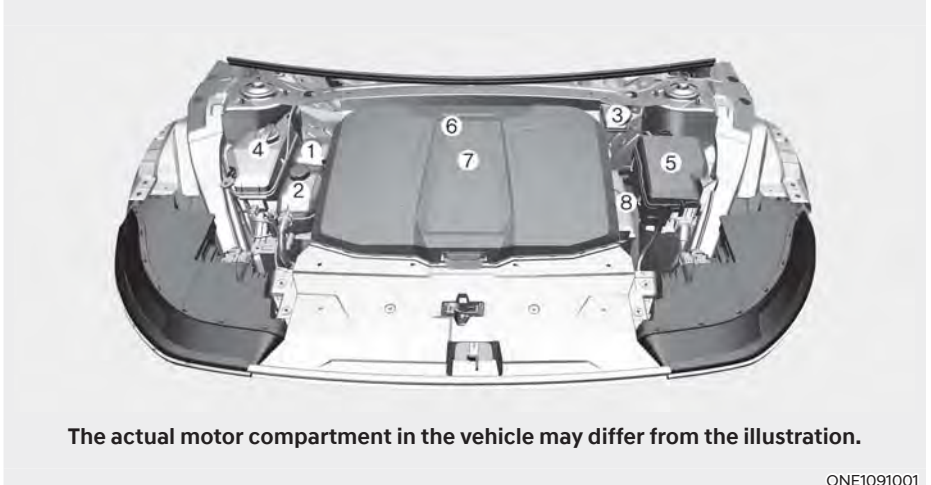

- | | | | |
|--|------|----------------------------|------|
| 1. Coolant reservoir | 9-12 | 5. Fuse box | 9-36 |
| 2. Low Conductivity Coolant | 9-12 | 6. Cabin air filter | 9-15 |
| 3. Brake fluid reservoir | 9-13 | 7. Front trunk | 5-74 |
| 4. Windshield washer fluid reservoir | 9-14 | 8. Battery (12 volt) | 9-19 |

DIMENSIONS

Items		in (mm)	
Overall length		182.48 (4,635)	
Overall width		74.41 (1,890)	
Overall height		63.9 (1,600) / 64.65 (1,642)*	
Tread	Tire size	Front	Rear
	19 in	64.49 (1,638)	64.84 (1,647)
	20 in	64.09 (1,628)	64.49 (1,637)
Wheelbase		118.11 (3,000)	

* : When measuring based on the shark fin antenna

ELECTRIC VEHICLE SPECIFICATIONS

Items		Standard type		Extended type	
		2WD	AWD	2WD	AWD
Motor	Max. output (kW)	125	53+120	168	74+165
	Max. torque (Nm)	350	255 + 350	350	255 + 350
Battery (Lithium-ion)	Capacity (kWh)	58	58	77.4	77.4
	Power output (kW)	195	195	272	272
	Voltage (V)	523	523	697	697
Charger (OBC)	Max. output (kW)	10.5 kW	10.5	10.9	10.9

OBC : On-Board Battery Chargers

BULB WATTAGE

Light bulb		Bulb type	Wattage	
Front	Headlight	Low	LED	
		High	LED	
	Turn signal lamp		STD : PY21W OPT : LED	STD : 21W OPT : LED
	Parking lamp		LED	LED
	Daytime Running Lamp (DRL)		LED	LED
	Side marker		LED	LED
	Front garnish lamp		LED	LED
	Front trunk lamp		LED	LED
Rear	Stop lamp		LED	LED
	Tail lamp		LED	LED
	Turn signal lamp		LED	LED
	Reverse lamp		STD : P21W OPT : LED	STD : P21W OPT : LED
	Side marker		LED	LED
	License plate lamp		LED	LED
	Fog lamp		LED	LED
	High mounted stop lamp		LED	LED
Interior	Front seat map and room lamp		LED	LED
	Rear seat room lamp (without vision roof)		LED	LED
	Rear seat personal lamp (with vision roof)		LED	LED
	Vanity mirror lamp		FESTOON 5W	5W
	Glove box lamp		LED	LED
	Door mood lamp		LED	LED
	Luggage compartment lamp		FESTOON 10W	10W

TIRES AND WHEELS

Items	Tire size	Wheel size	Battery type	Inflation pressure psi (kPa)				Wheel lug nut torque lbf-ft (kgf-m, N-m)
				Normal load		Maximum load		
				Front	Rear	Front	Rear	
Full size tire	235/55R 19	7.5J X 19	2WD Standard	36 (250)	36 (250)	36 (250)	36 (250)	79-94 (11-13, 108-127)
	235/55R 19	7.5J X 19	2WD Extended	38 (260)	38 (260)	38 (260)	38 (260)	
	235/55R 19	7.5J X 19	AWD Extended	36 (250)	37 (255)	36 (250)	37 (255)	
	255/45R20	8.5J X 20	AWD Extended	34 (235)	34 (235)	34 (235)	34 (235)	

NOTICE

- Ambient temperature affects the tire pressure (about 1 psi (7 kPa) for every 12°F (7°C) change). If colder temperatures are anticipated, it is permissible to increase cold tire inflation pressure by up to 3 psi (20 kPa) over the specification. If extreme temperature changes are expected, be sure to check and adjust tire pressure accordingly.
- Tire inflation pressure decreases with higher elevation, and increases with lower elevation (about 2.4 psi (10 kPa) for every mile (or kilometer) elevation change). Be sure to check and adjust tire pressure accordingly when driving through changing elevations.
- Do not exceed the maximum inflation pressure, as found on the sidewall of the tire(s).



CAUTION

When replacing tires, ALWAYS use the same size, type, brand, construction and tread pattern supplied with the vehicle. If not, it can damage the related parts or make it work irregularly.

AIR CONDITIONING SYSTEM

Item		Weight of volume	Classification
Refrigerant	Heat pump	900±25g (32±0.9 oz.)	R-1234yf
	Without heat pump	700±25g (25±0.9 oz.)	
Compressor lubricant	Heat pump	180±10 g (6.35±0.35 oz.)	POE J639
	Without heat pump	150±10 g (5.29±0.35 oz.)	

Contact an authorized HYUNDAI dealer for more details.

VEHICLE WEIGHT AND LUGGAGE VOLUME

Gross vehicle weight		Luggage volume
Standard type	Extended type	
2WD: 5,225 lbs. (2,370 kg) AWD: 5,467 lbs. (2,480 kg)	2WD: 5,357 lbs. (2,430 kg) 4WD: 5,600 lbs. (2,540 kg)	27.2 cu.ft (770 ℓ)

AVAILABLE FRONT TRUNK WEIGHT

2WD	4WD
55 lbs (25 kg)	25 lbs (10 kg)

Available front trunk weight depends on the specifications.

RECOMMENDED LUBRICANTS AND CAPACITIES

To help achieve proper vehicle performance and durability, use only lubricants of the proper quality.

These lubricants and fluids are recommended for use in your vehicle.

Lubricant			Volume	Classification	
Reduction gear fluid	2WD	Rear	3.6~3.7 US qt. (3.4~3.5 ℓ)	HK ATF 65 SP4M-1	
	4WD	Front	3.4~3.5 US qt. (3.2~3.3 ℓ)		
		Rear	3.6~3.7 US qt. (3.4~3.5 ℓ)		
Coolant	Standard type	with heat pump	2WD	6.6 US qt. (6.3 ℓ)	Designated coolant for electric vehicles
			4WD	7.2 US qt. (6.8 ℓ)	
		without heat pump	2WD	6.8 US qt. (6.4 ℓ)	
			4WD	7.2 US qt. (6.8 ℓ)	
	Extended type	with heat pump	2WD	6.6 US qt. (6.3 ℓ)	
			4WD	7.2 US qt. (6.8 ℓ)	
		without heat pump	2WD	6.8 US qt. (6.4 ℓ)	
			4WD	7.2 US qt. (6.8 ℓ)	
LCW Coolant	Standard type	with heat pump	2WD	9.9 US qt. (9.4 ℓ)	
			4WD	9.9 US qt. (9.4 ℓ)	
		without heat pump	2WD	9.3 US qt. (8.8 ℓ)	
			4WD	9.3 US qt. (8.8 ℓ)	
	Extended type	with heat pump	2WD	12.6 US qt. (11.9 ℓ)	
			4WD	12.3 US qt. (11.6 ℓ)	
		without heat pump	2WD	11.8 US qt. (11.2 ℓ)	
			4WD	12.4 US qt. (11.7 ℓ)	
Brake fluid			As required	SAE J1704 DOT-4 LV, FMVSS 116 DOT-4, ISO 4925 CLASS-6	

VEHICLE IDENTIFICATION NUMBER (VIN)

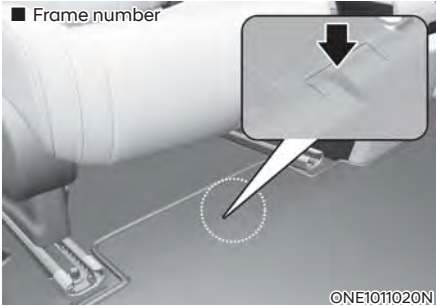

The vehicle identification number (VIN) is the number used in registering your vehicle and in all legal matters pertaining to its ownership, etc.

The number is punched on the floor under the right front seat. To check the number, open the cover.



The VIN is also on a plate attached to the top of the left side dashboard. The number on the plate can easily be seen through the windshield from outside.

VEHICLE CERTIFICATION LABEL



The vehicle certification label attached on the driver's (or front passenger's) side center pillar gives the vehicle identification number (VIN).

TIRE SPECIFICATION AND PRESSURE LABEL



The tires supplied on your new vehicle are chosen to provide the best performance for normal driving. The tire label located on the driver's side center pillar gives the tire pressures recommended for your vehicle.

MOTOR NUMBER

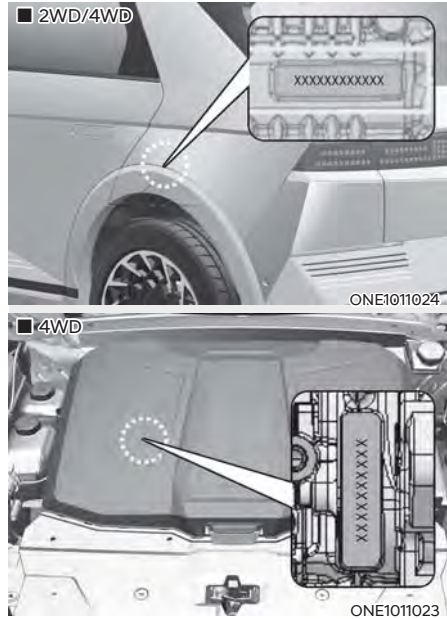

The motor numbers can be checked at the bottom of the vehicle.

AIR CONDITIONER COMPRESSOR LABEL

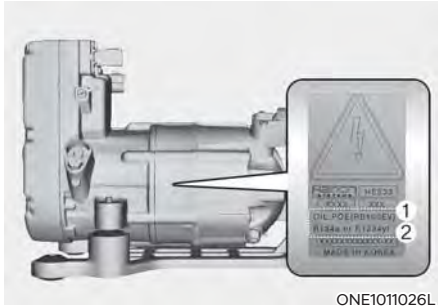

A compressor label informs you the type of compressor your vehicle is equipped with such as model, supplier part number, production number, refrigerant (1) and refrigerant oil (2).

REFRIGERANT LABEL



The refrigerant label provides information such as refrigerant type and amount. (R-1234yf)

CONSUMER INFORMATION

This consumer information has been prepared in accordance with regulations issued by the National Highway Traffic Safety Administration of the U.S. Department of Transportation. Your HYUNDAI dealer will help answer any questions you may have as you read this information.

HYUNDAI motor vehicles are designed and manufactured to meet or exceed all applicable safety standards.

For your safety, however, we strongly urge you to read and follow all directions in this Owner's Manual, particularly the information under the headings "**NOTICE**", "**CAUTION**" and "**WARNING**".

If, after reading this manual, you have any questions regarding the operation of your vehicle, please contact the Hyundai Customer Care Center.

Hyundai Customer Care
P.O. Box 20850
Fountain Valley, CA 92728
800-633-5151
consumeraffairs@hmausa.com

Hyundai's Customer Care representatives are available Monday through Friday, between the hours of 6:00 AM and 5:00 PM PST and Saturday between 6:30 AM and 3:00 PM PST (English).

For Customer Care assistance in Spanish or Korean, representatives are available Monday through Friday between 6:30 AM and 3:00 PM PST.

REPORTING SAFETY DEFECTS

If you believe that your vehicle has a defect which could cause a crash or could cause injury or death, you should immediately inform the National Highway Traffic Safety Administration (NHTSA) in addition to notifying HYUNDAI MOTOR AMERICA.

To contact NHTSA, you may call the Vehicle Safety Hotline toll-free at 1-888-327-4236 (TTY: 1-800-424-9153);

go to <http://www.safercar.gov>;

download the SaferCar mobile application;

or write to: Administrator, NHTSA

1200 New Jersey Ave, SE,

West Building Washington, D.C. 20590.

You can also obtain other information about motor vehicle safety from <http://www.safercar.gov>.

If NHTSA receives similar complaints, it may open an investigation, and if it finds that a safety defect exists in a group of vehicles, it may order a recall and remedy campaign. However, NHTSA cannot become involved in individual problems between you, your dealer, or HYUNDAI MOTOR AMERICA.

3. Seats & Safety System

- Important Safety Precautions3-2
 - Always Wear Your Seat Belt 3-2
 - Restrain All Children 3-2
 - Air Bag Hazards 3-2
 - Driver Distraction 3-2
 - Control Your Speed 3-2
 - Keep Your Vehicle In Safe Condition 3-2
- Seats 3-3
 - Safety Precautions 3-6
 - Front Seats 3-7
 - Rear Seats 3-16
 - Head Restraint 3-20
 - Seat Warmers 3-24
 - Air Ventilation Seats 3-26
- Seat Belts 3-28
 - Seat Belt Safety Precautions 3-28
 - Seat Belt Warning Light 3-29
 - Seat Belt Restraint System 3-30
 - Additional Seat Belt Safety Precautions 3-35
 - Care of Seat Belts 3-37
- Child Restraint System (CRS) 3-38
 - Children Always in the Rear 3-38
 - Selecting a Child Restraint System (CRS) 3-39
 - Installing a Child Restraint System (CRS) 3-40
- Air Bag - Supplemental Restraint System 3-48
 - Where are the Air Bags? 3-50
 - How does the Air Bags System Operate? 3-53
 - What to Expect After an Air Bag Inflates 3-57
 - Occupant Classification System (OCS) 3-58
 - Why didn't my air bag go off in a collision? 3-64
 - SRS Care 3-69
 - Additional Safety Precautions 3-70
 - Air Bag Warning Labels 3-70

IMPORTANT SAFETY PRECAUTIONS

You will find many safety precautions and recommendations throughout this section, and throughout this manual. The safety precautions in this section are among the most important.

Always Wear Your Seat Belt

A seat belt is your best protection in all types of accidents. Air bags are designed to supplement seat belts, not to replace them. So even though your vehicle is equipped with air bags, ALWAYS make sure you and your passengers wear your seat belts, and wear them properly.

Restrain All Children

All children under age 13 should ride in your vehicle properly restrained in a rear seat, not the front seat. Infants and small children should be restrained in an appropriate Child Restraint System. Larger children should use a booster seat with the lap/shoulder belt until they can use the seat belt properly without a booster seat.

Air Bag Hazards

While air bags can save lives, they can also cause serious or fatal injuries to occupants who sit too close to them, or who are not properly restrained. Infants, young children, and short adults are at the greatest risk of being injured by an inflating air bag. Follow all instructions and warnings in this manual.

Driver Distraction

Driver distraction presents a serious and potentially deadly danger, especially for inexperienced drivers. Safety should be the first concern when behind the wheel and drivers need to be aware of the wide array of potential distractions, such as drowsiness, reaching for objects, eating, personal grooming, other passengers, and using mobile phones.

Drivers can become distracted when they take their eyes and attention off the road or their hands off the wheel to focus on activities other than driving. To reduce your risk of distraction and an accident:

- Set up your mobile devices (for example, MP3 players, phones, navigation units, etc.) ONLY when your vehicle is parked or safely stopped.
- ONLY use your mobile device when allowed by laws and conditions permit safe use. NEVER text or email while driving. Most countries have laws prohibiting drivers from texting. Some countries and cities also prohibit drivers from using handheld phones.
- NEVER let the use of a mobile device distract you from driving. You have a responsibility to your passengers and others on the road to always drive safely, with your hands on the wheel as well as your eyes and attention on the road.

Control Your Speed

Excessive speed is a major factor in crash injuries and deaths. Generally, the higher the speed, the greater the risk, but serious injuries can also occur at lower speeds. Never drive faster than is safe for current conditions, regardless of the maximum speed posted.

Keep Your Vehicle In Safe Condition

Having a tire blowout or a mechanical failure can be extremely hazardous. To reduce the possibility of such problems, check your tire pressures and condition frequently, and perform all regularly scheduled maintenance.

SEATS

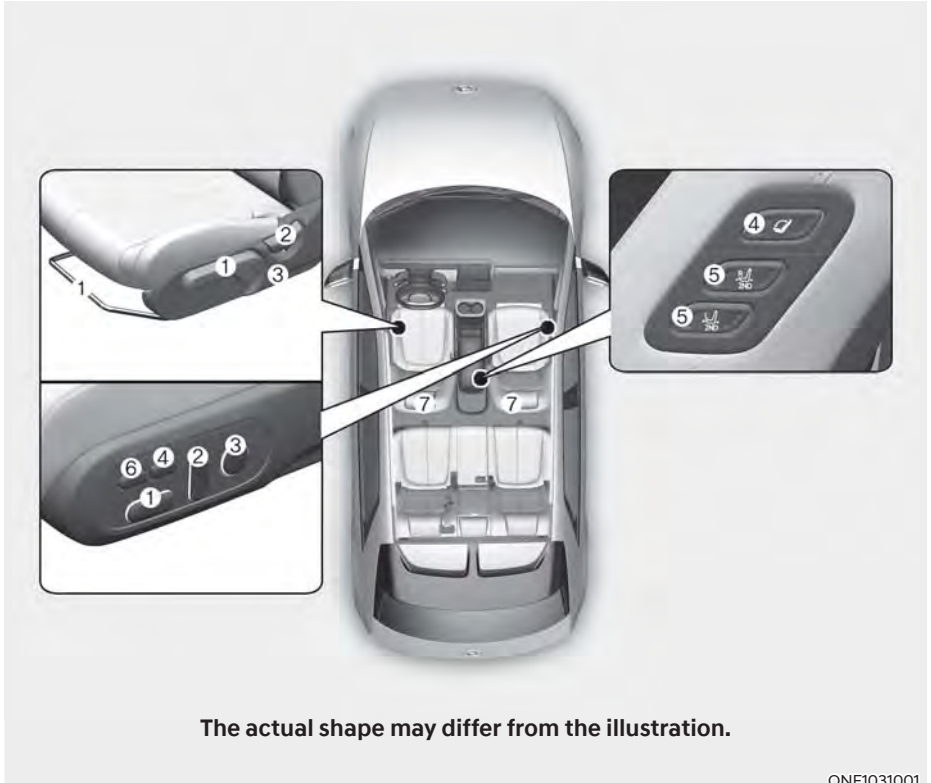

ONE1031001

Front seat

- (1) Seat sliding forward or rearward/Cushion height/Seat cushion(Relaxation comfort) angle
- (2) Seatback angle
- (3) Lumbar support

- (4) Relaxation comfort seat switch
- (5) Rear seat control switch
- (6) Leg support
- (7) Head restraint

* Relaxation: Relax + Position

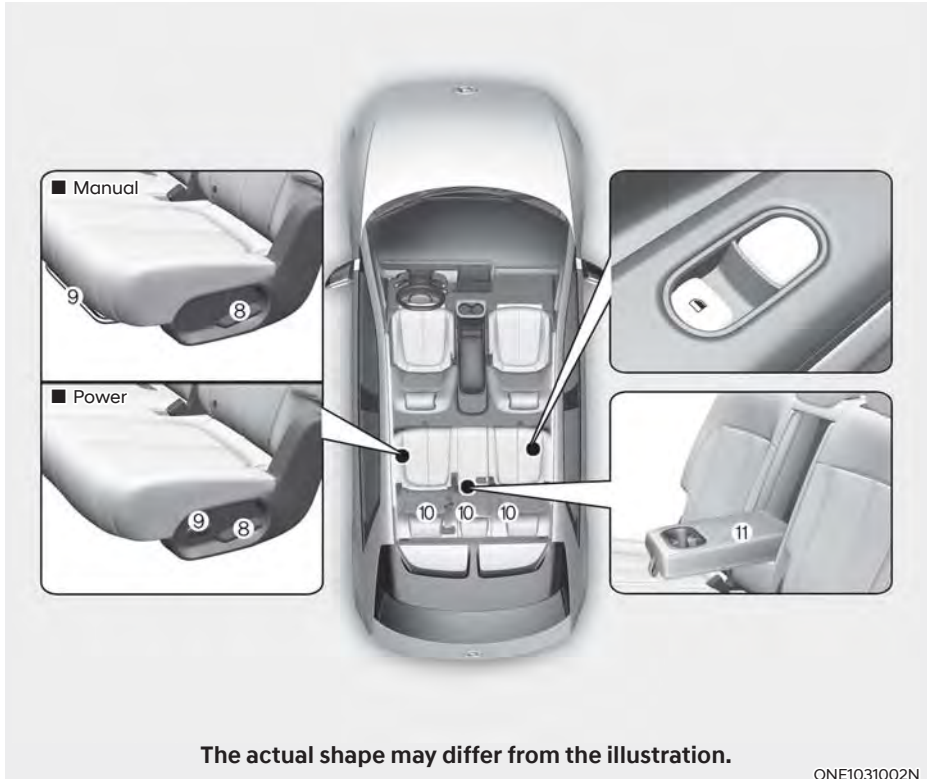

Rear seat

- (8) Seatback angle / Seatback folding lever
- (9) Seat slide forward or rearward

(10) Head restraint

(11) Armrest

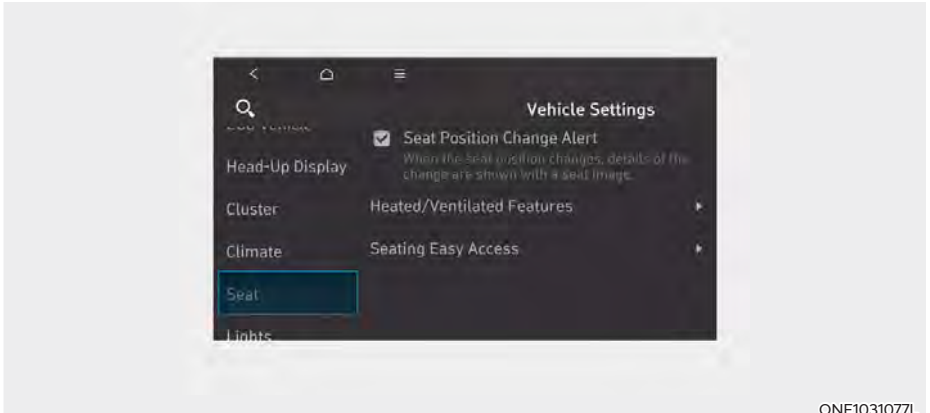

ONE1031077L

Infotainment system

Select 'Setup → Vehicle Settings → Seat' from the Settings menu in the infotainment system screen, you may use various convenience functions.

- Seat position change alert : When the seat position changes, details of the change are shown with a seat image.
- Heated/Ventilated features
 - Auto. Controls That Use Climate Control Settings (for driver's seat) : The seat temperature is automatically controlled.
- Seating easy access
 - Steering wheel easy access : Moves the steering wheel when the driver enters or leaves the vehicle.
 - Driver seat easy access : The distance (Normal/Extended/Off) the seat automatically moves when the driver enters or leaves the vehicle may be selected.

For detailed information, refer to the separately supplied infotainment system manual.

Information

The information provided may differ depending on which functions are applicable to your vehicle.

Safety Precautions

Adjusting the seats so that you are sitting in a safe and comfortable position plays an important role for the safety of the driver and passengers, as much as seat belts and air bags when in an accident.

WARNING

Do not use a cushion that reduces friction between the seat and the passenger. The passenger's hips may slide under the lap portion of the seat belt during an accident or a sudden stop.

Serious or fatal internal injuries could result because the seat belt cannot operate properly.

Air bags

You can take steps to reduce the risk of being injured by an inflating air bag. Sitting too close to an air bag greatly increases the risk of injury in the event the air bag inflates. Move your seat as far back as possible from front air bags, while still maintaining control of the vehicle.

WARNING

To reduce the risk of serious injury or death from an inflating air bag, take the following precautions:

- Adjust the driver's seat as far to the rear as possible while maintaining the ability to control the vehicle.
- Adjust the front passenger seat as far to the rear as possible.
- Hold the steering wheel by the rim with your hands at the 9 o'clock and 3 o'clock positions to minimize the risk of injuries to your hands and arms.
- NEVER place anything or anyone between you and the air bag.
- Do not allow the front passenger to place feet or legs on the dashboard to minimize the risk of leg injuries.

Seat belts

Always fasten your seat belt before starting any trip. At all times, passengers should sit upright and be properly restrained. Infants and small children must be restrained in appropriate Child Restraint Systems. Children who have outgrown a booster seat and adults must be restrained using the seat belts.



WARNING

Take the following precautions when adjusting your seat belt:

- **NEVER** use one seat belt for more than one occupant.
- **Always** position the seatback upright with the lap portion of the seat belt snug and low across the hips.
- **NEVER** allow children or small infants to ride on a passenger's lap.
- **Do not** route the seat belt across your neck, across sharp edges, or reroute the shoulder strap away from your body.
- **Do not** allow the seat belt to become caught or jammed.

Front Seats



WARNING

Take the following precautions when adjusting your seat:

- **NEVER** attempt to adjust the seat while the vehicle is moving. The seat could respond with unexpected movement and may cause loss of vehicle control resulting in an accident.
- **Do not** place anything under the front seats. Loose objects in the driver's foot area could interfere with the operation of the foot pedals, causing an accident.
- **Do not** allow anything to interfere with the normal position and proper locking of the seatback.
- **Do not** place a cigarette lighter on the floor or seat. When you operate the seat, gas may exit out of the lighter causing a fire.
- **Use extreme caution** when picking up small objects trapped under the seats or between the seat and the center console. Your hands might be cut or injured by the sharp edges of the seat mechanism.
- **If there are occupants in the rear seats, be careful while adjusting the front seat position.**
- **Make sure that the seat is locked in place after the adjustment. If not, the seat might move unexpectedly resulting in an accident.**

CAUTION

To prevent injury:

- Do not adjust your seat while wearing your seat belt. Moving the seat cushion forward may cause strong pressure on your abdomen.
- Do not allow your hands or fingers to get caught in the seat mechanisms while the seat is moving.

WARNING

NEVER allow children in the vehicle unattended. The power seats are operable when the vehicle is turned off.

NOTICE

To prevent damage to the seats:

- Always stop adjusting the seats when the seat has been adjusted as far forward or rearward as possible.
- Do not adjust the seats longer than necessary when the vehicle is turned off. This may result in unnecessary battery drain.
- Do not operate two or more seats at the same time. This may result in an electrical malfunction.

Manual adjustment (if equipped)

The front seat can be adjusted by using the levers located underneath the seat cushion. Before driving, adjust the seat to the proper position so that you can easily control the steering wheel, foot pedals and controls on the instrument panel.

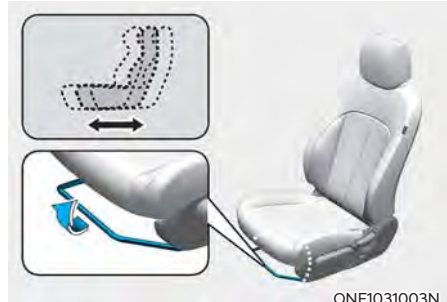

Forward and rearward adjustment

To move the seat forward or rearward:

1. Pull up the seat slide adjustment lever and hold it.
2. Slide the seat to the position you desire.
3. Release the lever and make sure the seat is locked in place. Move forward and rearward without using the lever. If the seat moves, it is not locked properly.

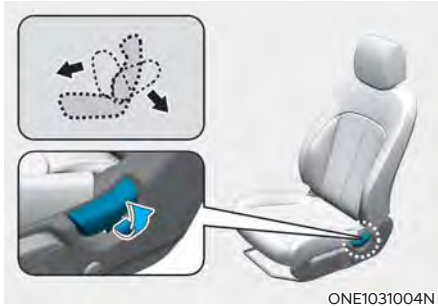

ONE1031004N

Seatback angle

To recline the seatback:

1. Lean forward slightly and lift up the seatback lever.
2. Carefully lean back on the seat and adjust the seatback to the position you desire.
3. Release the lever and make sure the seatback is locked in place. (The lever **MUST** return to its original position for the seatback to lock.)

Reclining seatback

Sitting in a reclined position when the vehicle is in motion can be dangerous. Even when buckled up, the protections of your restraint system (seat belts and/or air bags) is greatly reduced by reclining your seatback.



WARNING

NEVER ride with a reclined seatback when the vehicle is moving.

Riding with a reclined seatback increases your chance of serious or fatal injuries in the event of a collision or sudden stop.

Drivers and passengers should ALWAYS sit well back in their seats, properly belted, and with the seatbacks upright.

Seat belts must be snug against your hips and chest to work properly. When the seatback is reclined, the shoulder belt cannot do its job because it will not be snug against your chest. Instead, it will be in front of you. During an accident, you could be thrown into the seat belt, causing neck or other injuries.

The more the seatback is reclined, the greater chance the passenger's hips will slide under the lap belt or the passenger's neck will strike the shoulder belt.

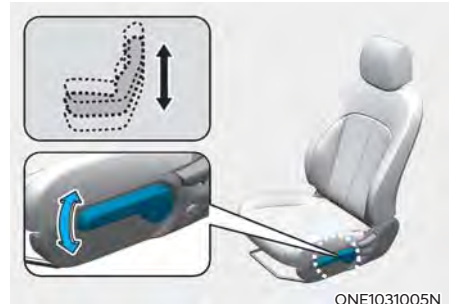

ONE1031005N

Seat height

To change the height of the seat cushion:

- Push down the lever several times, to lower the seat cushion.
- Pull up the lever several times, to raise the seat cushion.

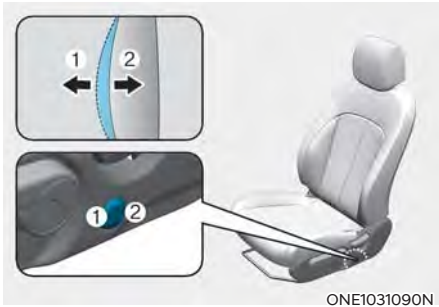

Lumbar support

To adjust the lumbar support:

- Press the front portion of the switch (1) to increase the support or the rear portion of the switch (2) to decrease the support.

NOTICE

Do not continue to operate the lumbar support when the lumbar support provides its maximum support. Damage to the lumbar support motor could occur.

Power adjustment (if equipped)

The front seat can be adjusted by using the control switches located on the outside of the seat cushion. Before driving, adjust the seat to the proper position so that you can easily control the steering wheel, foot pedals and controls on the instrument panel.

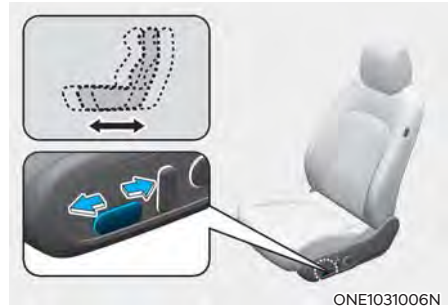

Forward and rearward adjustment

To move the seat forward or rearward:

1. Push the control switch forward or rearward.
2. Release the switch once the seat reaches the desired position.

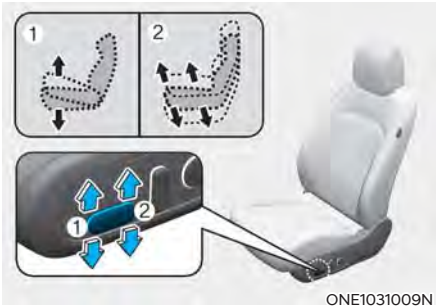

Seat cushion tilt/height adjustment

- Seat cushion tilt (1)

To change the angle of the front part of the seat cushion:

Push the front portion of the control switch up to raise or down to lower the front part of the seat cushion.

Release the switch once the seat reaches the desired position.

- Seat height (2)

To change the height of the seat cushion:

Push the rear portion of the control switch up to raise or down to lower the height of the seat cushion.

Release the switch once the seat reaches the desired position.

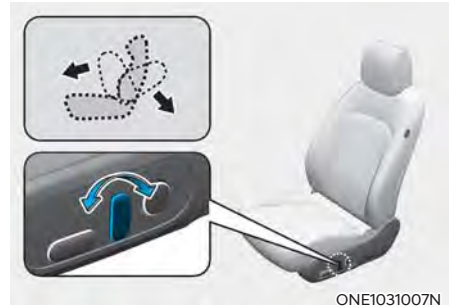

Seatback angle adjustment

To recline the seatback:

1. Push the control switch forward or rearward.
2. Release the switch once the seatback reaches the desired position.

Reclining seatback

Sitting in a reclined position when the vehicle is in motion can be dangerous. Even when buckled up, the protections of your restraint system (seat belts and air bags) is greatly reduced by reclining your seatback.

WARNING

NEVER ride with a reclined seatback when the vehicle is moving.

Riding with a reclined seatback increases your chance of serious or fatal injuries in the event of a collision or sudden stop.

Driver and passengers should ALWAYS sit well back in their seats, properly belted, and with the seatbacks upright.

Seat belts must be snug against your hips and chest to work properly. When the seatback is reclined, the shoulder belt cannot do its job because it will not be snug against your chest. Instead, it will be in front of you. During an accident, you could be thrown into the seat belt, causing neck or other injuries.

The more the seatback is reclined, the greater chance the passenger's hips will slide under the lap belt or the passenger's neck will strike the shoulder belt.



Leg support adjustment (if equipped)

1. Press the front portion of the switch (1) to raise the leg support.
2. Press the rear portion of the switch (2) to lower the leg support.



Lumbar support

To adjust the lumbar support:

- Press the front portion of the switch (1) to increase support or the rear portion of the switch (2) to decrease support.

NOTICE

Do not continue to operate the lumbar support when the lumbar support provides its maximum support. Damage to the lumbar support motor could occur.

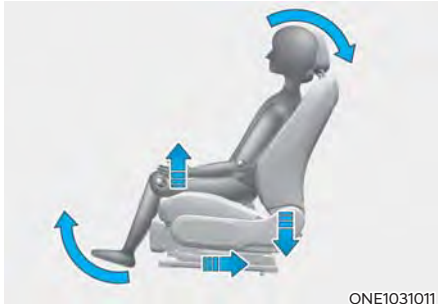

ONE1031011

Relaxation comfort seat (for Driver's seat, if equipped)

Relaxation comfort seats help distribute body pressure and concentrated weight on specific body parts that occur while sitting in the same position for a long period of time. The seat helps relieve fatigue and discomfort by providing the optimal sit position.



CAUTION

Take the following precautions when using the relaxation comfort seat:

- Do not use the relaxation comfort seat while the vehicle is moving. Using the comfort seat could increase the risk of injuries in the event of a collision or sudden stop.
- Do not use the relaxation comfort seat when the luggage or other objects are placed at the rear seat.
- Do not use the relaxation comfort seat while the vehicle is moving. Seat belts may not operate normally due to the lack of adherence between the shoulder belts and the body.
- Do not use the relaxation comfort seat when the rear seats are not in the rearmost position and upright.



ONE1031013N

To activate relaxation comfort seat

Press the switch (1) more than 0.5 seconds, an alarm appears on the infotainment screen. Then, press the switch (1) again for more than 0.5 seconds.

If the switch is not pressed within 5 seconds after the alarm appears, relaxation comfort seat will not be activated.

When relaxation comfort seat is activated:

1. The seat cushion will be moved forward or rearward automatically.
2. The seat cushion, seatback angle and leg support will be adjusted.

In the following cases, an alarm appears on when the infotainment screen is on and the relaxation comfort seat will be deactivated.

- When the gear is not in P (Parking).
- When the vehicle is moving more than 1.8 mph (3 km/h).
- When the rear seat belt is fastened

i Information

When relaxation comfort seat cannot be operated, try to reset Integrated Memory System. If relaxation comfort seat does not operate even after Integrated Memory System is reset, contact an authorized HYUNDAI dealer.

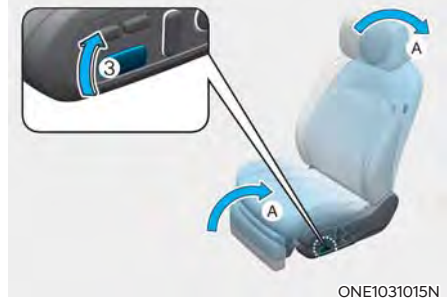
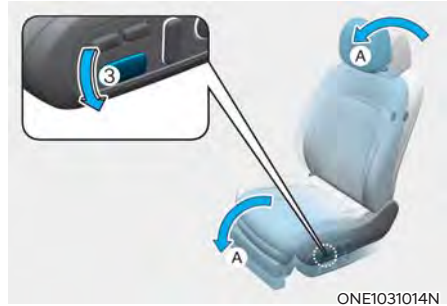

[A] : Moves simultaneously

You can adjust moves simultaneously the seat directly by using the seat adjustment switches (3).

Push down the forward part of the switch (3) to move back the chair to the original position.

Pull up the forward part of the switch (3) to adjust the seat to the relaxation comfort position.

Even when the relaxation comfort seat is operated by others, the additional adjustment is possible by pressing relaxation comfort seat switches.

- To deactivate relaxation comfort seat
If you press the front portion of the switch (2) while the seat is in the relaxation comfort seat position, the seat return backs to the original position.

When relaxation comfort seat is deactivated:

- The driver seat will return to the position which the gear was in P (Park).
- Passenger seat will return to the original position.

In the following cases, the relaxation comfort seat will not return to the original position for the driver' seat.

- When the gear is not in P (Parking).
- When the vehicle is moving more than 1.8 mph (3 km/h).

i Information

When relaxation comfort seat cannot be operated, try to reset Integrated Memory System. If relaxation comfort seat does not operate even after Integrated Memory System is reset, contact an authorized HYUNDAI dealer.

NOTICE

Do not use the seat switches simultaneously. It may damage the seat system.

Seatback pocket

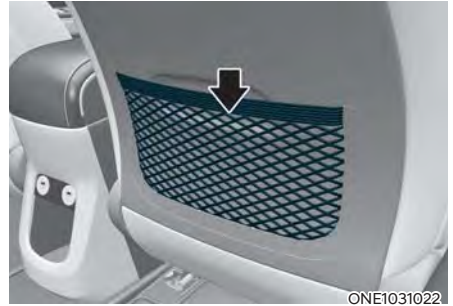

The seatback pocket is provided on the back of the front seatbacks.



CAUTION

Do not put heavy or sharp objects in the seatback pockets. In an accident they could come loose from the pocket and injure occupants.

Rear Seats

Rear seat control switch (if equipped)



The front and rear seat passengers may use the switches to control the rear seats.

- Sliding forward or rearward:
Press the switch (1) or (2) to move the second row right side seat forward or rearward.
Press the switch (3) or (4) to move the second row left side seat forward or rearward.



WARNING

Take the following precautions:

- **Adjusting the seats**
 - **NEVER** attempt to adjust the seat while the vehicle is moving. The seat may suddenly move and may injure the passenger.
 - **Make sure that the seat is locked in place after the adjustment.** If not, the seat might move unexpectedly resulting in an accident.
- **Folding the seats**
 - Do not fold the seatback when the seat is occupied (for example, passenger, pets or luggage). It may injure the passenger or pet, or damage the luggage.
 - Never allow passengers to sit on top of the folded down seatback while the vehicle is moving. This is not a proper seating position and no seat belts are available for use. This could result in serious injury or death in case of an accident or sudden stop.
 - Objects carried on the folded down seatback should not extend higher than the top of the front seatbacks. This could allow cargo to slide forward and cause injury or damage during sudden stops.
 - When returning the rear seatback from a folded to an upright position, hold the seatback and return it slowly. Ensure that the seatback is completely locked into its upright position by pushing on the top of the seatback. In an accident or sudden stop, the unlocked seatback could allow cargo to move forward with great force and enter the passenger compartment, which could result in serious injury or death.
 - When folding the seatback, slightly pushing the seatback or head restraint against the folding direction to control the folding speed. Without the push, the seatback may abruptly fold down and cause injuries when the lever is pulled.

- **Loading cargo**
 - Make sure the vehicle is off, the gear shifted to P (Park), and the parking brake is securely applied whenever loading or unloading cargo. Failure to take these steps may allow the vehicle to move if the shift button or shift dial is inadvertently pressed or rotated to another position.
 - When cargo is loaded through the rear passenger seats, ensure the cargo is properly secured to prevent it from moving while driving.
- **Do not place objects in the rear seats, since they cannot be properly secured and may hit vehicle occupants in a collision causing serious injury or death.**



CAUTION

Do not allow your hands or fingers to get caught in the seat mechanisms while adjusting the seats.

NOTICE

To prevent damage to the vehicle:

- **Rear seat belts**
Before folding the seatback, insert the seat belt buckle in the holder between the seatback and cushion. And insert the seat belt webbing in the guide to prevent the seat belt from being damaged.
- **Cargo**
Be careful when loading cargo through the rear passenger seats to prevent damage to the vehicle interior.

Manual adjustment

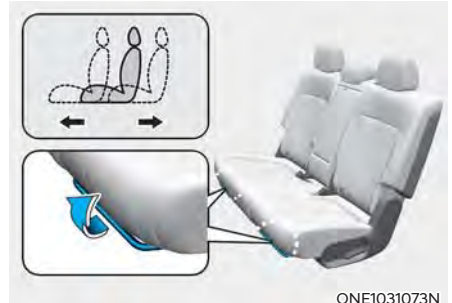

ONE1031073N

Forward and rearward

To move the seat forward or rearward:

1. Pull the seat slide adjustment lever up and hold it.
2. Slide the seat to the position you desire.
3. Release the lever and make sure the seat is locked in place.



Information

For the optimal safety, slide the rear seat to the rearmost position.

Power adjustment (if equipped)

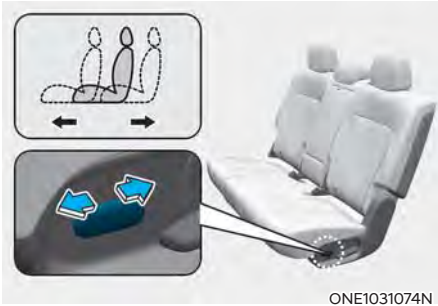

Forward and rearward

To move the seat forward or rearward:

1. Push the control switch forward or rearward.
2. Release the switch once the seat reaches the desired position.

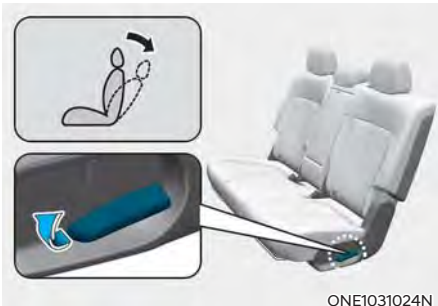

Seatback angle

To recline the seatback:

1. Pull up the seatback recline lever.
2. Hold the lever and adjust the seatback of the seat to the position you desire.
3. Release the lever and make sure the seatback is locked in place. The lever MUST return to its original position for the seatback to lock.

* The seatbacks can be folded with the seatback recline lever.

Folding the rear seats

The rear seatbacks can be folded to facilitate carrying long items or to increase the luggage capacity of the vehicle.

To fold down the rear seatback:

1. Set the front seatback to the upright position and if necessary, slide the front seat forward.

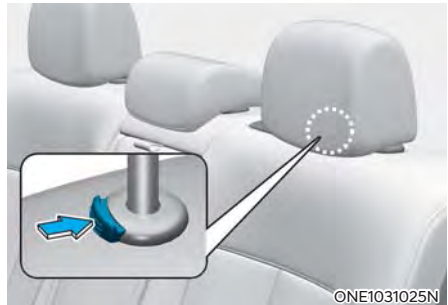

2. Lower the rear head restraints to the lowest position.



3. Route the seat belt webbing to the outward of the rear seat to prevent the belts from being trapped behind or under the seats.

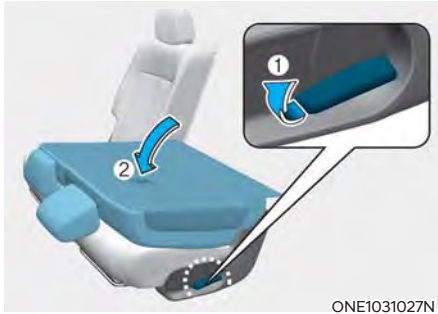

4. Pull up the seatback folding lever (1), then fold the seat (2) toward the front of the vehicle. When you return the seatback to its upright position, always be sure it has locked into position by pushing on the top of the seatback.



5. To use the rear seat, lift and unfold the seatback (2) to the upright position by pulling up the folding lever (1). Push the seatback firmly until it clicks into place. Make sure the seatback is locked in place.
6. Return the rear seat belt to the proper position.

Armrest



The armrest is located in the center of the rear seat. Pull the armrest down from the seatback to use it.

CAUTION

The armrest handle may be pressed when folding the rear seatback, but it will be restored after a certain period of time.

Head Restraint

The vehicle's front and rear seats have adjustable head restraints. The head restraints provide comfort for passengers, but more importantly they are designed to help protect passengers from whiplash and other neck and spinal injuries during an accident, especially in a rear impact collision.

WARNING

To reduce the risk of serious injury or death in an accident, take the following precautions when adjusting your head restraints:

- Always properly adjust the head restraints for all passengers **BEFORE** starting the vehicle.
- **NEVER** let anyone ride in a seat with the head restraint removed or reversed.

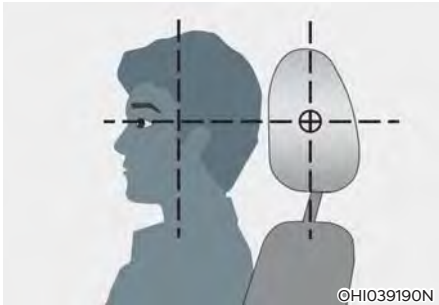

- Adjust the head restraints so the middle of the head restraint is at the same height as the height of the top of the eyes.
- **NEVER** adjust the head restraint position of the driver's seat when the vehicle is in motion.
- Adjust the head restraint as close to the passenger's head as possible. Do not use a seat cushion that holds the body away from the seatback.
- Make sure the head restraint locks into position after adjusting it.

WARNING

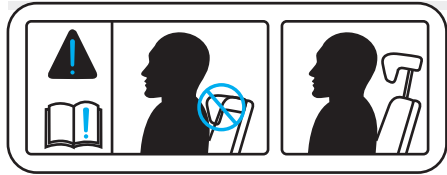

OTL035061

When sitting on the rear seat, do not adjust the height of the head restraint to the lowest position.

CAUTION

When there is no occupant in the rear seats, adjust the height of the head restraint to the lowest position. The rear seat head restraint can reduce the visibility of the rear area.

NOTICE

To prevent damage, **NEVER** hit or pull on the head restraints.

Front seat head restraints



ONE1031076L

The driver's and front passenger's seats are equipped with adjustable head restraints for the passengers safety and comfort.

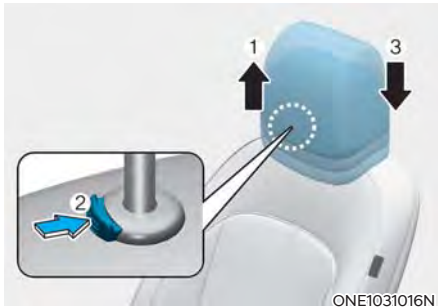

ONE1031016N

Adjusting the height up and down

To raise the head restraint:

1. Pull it up to the desired position (1).

To lower the head restraint:

1. Push and hold the release button (2) on the head restraint support.
2. Lower the head restraint to the desired position (3).

NOTICE



OHI038136

If you recline the seatback towards the front with the head restraint and seat cushion raised, the head restraint may come in contact with the sunvisor or other parts of the vehicle.

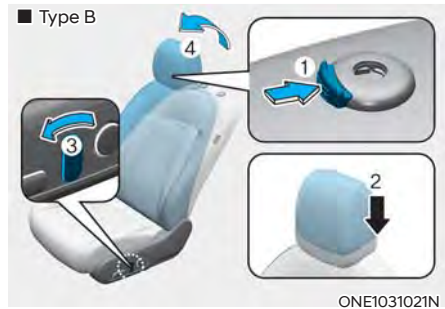
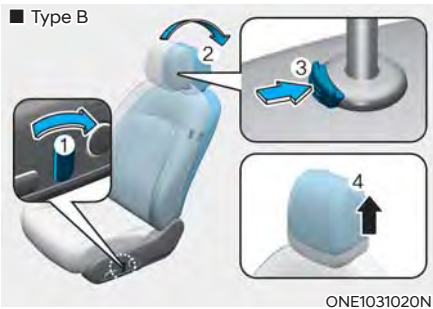
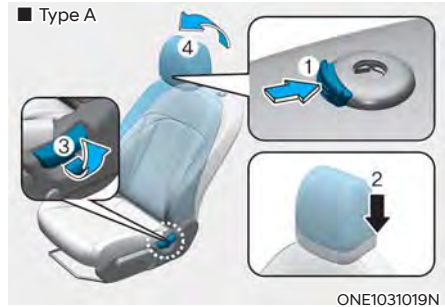
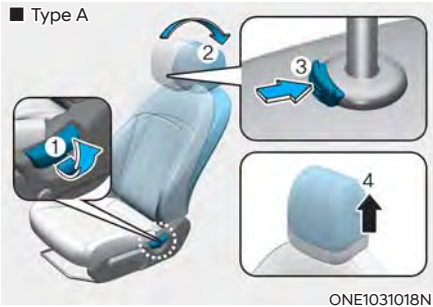

Removal/Reinstall

To remove the head restraint:

1. Recline the seatback (2) with the seatback angle switch (1).
2. Pull up the head restraint to the upmost position and press the release button (3) to remove the head restraint (4).

WARNING

NEVER allow anyone to travel in a seat with the head restraint removed.

To reinstall the head restraint :

1. Recline the seat back by pressing seatback angle lever or switch (3).
2. Put the head restraint poles (2) into the holes while pressing the release button (1).
3. Adjust the head restraint to the appropriate height.
4. Adjust the seatback angle (4) with the seatback angle switch (3).

WARNING

Always make sure the head restraint locks into position after reinstalling and adjusting it properly.

Rear seat head restraints



The rear seats are equipped with head restraints in all the seating positions for the passenger's safety and comfort.

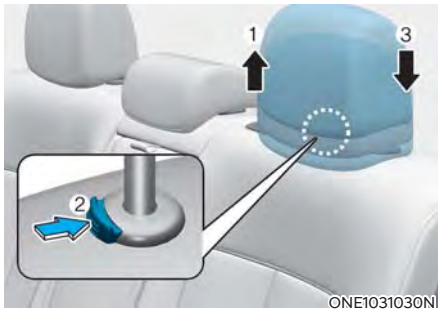

Adjusting the height up and down

To raise the head restraint:

1. Pull it up to the desired position (1).

To lower the head restraint:

1. Push and hold the release button (2) on the head restraint support.
2. Lower the head restraint to the desired position (3).

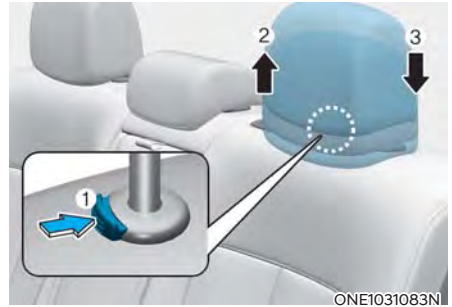

Removal/Reinstallation

To remove the head restraint:

1. Raise the head restraint as far as it can go.
2. Press the head restraint release button (1) while pulling the head restraint up (2).

To reinstall the head restraint:

1. Put the head restraint poles into the holes (3) while pressing the release button (1).
2. Adjust the head restraint to the appropriate height.

Seat Warmers

Seat warmers are provided to warm the seats during cold weather.

During mild weather or under conditions where the operation of the seat warmer is not needed, keep the seat warmers OFF.



WARNING

The seat warmers can cause a **SERIOUS BURN**, even at low temperatures and especially if used for long periods of time.

Passengers must be able to feel if the seat is becoming too warm so they can turn it off, if needed.

Seat warmer consume large amounts of electricity. Please avoid using seat warmers while the vehicle is off in order to prevent battery discharge.

People who cannot detect temperature change or pain to the skin should use extreme caution, especially the following types of passengers:

- Infants, children, elderly or disabled persons, or hospital outpatients.
- People with sensitive skin or who burn easily.
- Fatigued individuals.
- Intoxicated individuals.
- People taking medication that can cause drowsiness or sleepiness.



WARNING

NEVER place anything on the seat that insulates against heat when the seat warmer is in operation, such as a blanket or seat cushion. This may cause the seat warmer to overheat, causing a burn or damage to the seat.

NOTICE

To prevent damage to the seat warmers and seats:

- Never use a solvent such as paint thinner, benzene, alcohol or gasoline to clean the seats.
- Do not place heavy or sharp objects on seats equipped with seat warmers.
- Do not change the seat cover. It may damage the seat warmer.

Front seat warmers

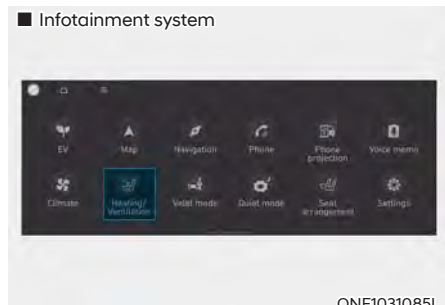

While the vehicle is running, touch Heating/Ventilation icon in the infotainment home screen.

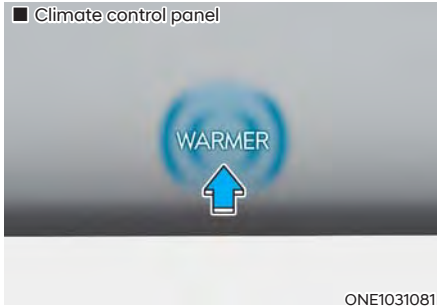

Press WARMER in the front climate control panel.



To activate seat warmer of each front seats, touch \wedge icon on the infotainment screen. Adjust the temperature by pressing either \wedge or \vee icons.

The seat warmer will automatically stop when the seat temperature reaches certain level and will automatically reactivate when the seat temperature drops below certain temperature.

- Manual temperature control
Refer to the infotainment system web manual for manual temperature control.
- Automatic temperature control
The seat warmer starts to automatically control the seat temperature in order to prevent low temperature burns after being manually turned on.



You may manually touch the icon to increase seat temperature. However, the seat temperature is automatically adjusted again.

- Auto. Controls That Use Climate Control Settings (for driver's seat)
The seat warmer automatically controls the seat temperature depending on the ambient temperature when the vehicle is running.
To use this function, it must be enabled from the Settings menu in the infotainment system screen. Select:
- Setup \rightarrow Vehicle Settings \rightarrow Seat \rightarrow Heated/Ventilated Features \rightarrow Auto. Controls That Use Climate Control Settings \rightarrow Seat Warmer/Ventilation
- The seat warmer defaults to the OFF position whenever the Start/Stop button is pressed to the ON position. However, if the Auto. Controls That Use Climate Control Settings function is On, the driver's seat warmer will turn on and off depending on the ambient temperature.

Air Ventilation Seats

The air ventilation seats are provided to cool the front seats by blowing air through small vent holes on the surface of the seat cushions and seatbacks.

When the operation of the air ventilation seat is not needed, keep the air ventilation seats OFF.

NOTICE

To prevent damage to the air ventilation seats:

- Never use a solvent such as paint thinner, benzene, alcohol or gasoline to clean the seats.
- Avoid spilling liquids on the surface of the front seats and seatbacks; this may cause the air vent holes to block and not work properly.
- Do not place materials such as plastic bags or newspapers under the seats. They may block the air intake causing malfunction of the air vent.
- Do not change the seat covers. It may damage the air ventilation seat.
- If the air vents do not operate, restart the vehicle. If there is no change, have the vehicle to be inspected by an authorized HYUNDAI dealer.

Front air ventilation seats (if equipped)

■ Infotainment system



ONE1031085L

While the vehicle is running, touch Heating/Ventilation icon in the infotainment home screen.

■ Climate control panel



ONE1031081

Press WARMER in the front climate control panel.

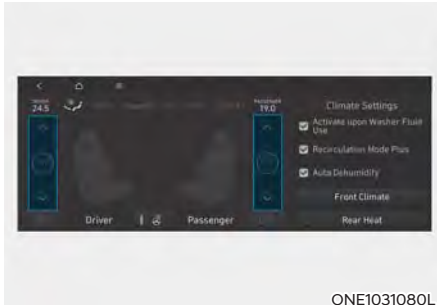

ONE1031080L

To activate air ventilation of each front seats, touch ∇ icon on the infotainment screen. Adjust the airflow by pressing either \wedge or ∇ icons.

- If the air ventilation seat is positioned at HIGH, the airflow speed will increase according to vehicle speed.
- Use the air ventilation seat with the air conditioning on for more effective ventilation.
- It may take 3~5 minutes after switch operation to feel the temperature change.

Refer to the infotainment system web manual for manual temperature control.

- **Auto. Controls That Use Climate Control Settings (for driver's seat)**
The air ventilation seat automatically controls the seat temperature depending on the ambient temperature when the vehicle is running.
To use this function, it must be enabled from the Settings menu in the infotainment system screen. Select:
 - Setup → Vehicle Settings → Seat → Heated/Ventilated Features → Auto. Controls That Use Climate Control Settings → Seat Warmer/Ventilation
- The air ventilation seats defaults to the OFF position whenever the Start/Stop button is pressed to the ON position. However, if the Auto. Controls That Use Climate Control Settings function is on, the driver's seat warmer will turn on and off depending on the ambient temperature.

SEAT BELTS

This section describes how to use the seat belts properly. It also describes some of the things not to do when using seat belts.

Seat Belt Safety Precautions

Always fasten your seat belt and make sure all passengers have fastened their seat belts before starting any trip. Air bags are designed to supplement the seat belt as an additional safety device, not a replacement. Most states require all occupants of a vehicle to wear seat belts.



WARNING

Seat belts must be used by **ALL** passengers whenever the vehicle is moving. Take the following precautions when adjusting and wearing seat belts:

- Children under the age of 13 should be properly restrained in the rear seats.
- Never allow children to ride in the front passenger seat, unless the air bag is deactivated. If a child is seated in the front passenger seat, move the seat as far back as possible. And the child must always be restrained in the seat properly.
- **NEVER** allow an infant or child to be carried on an occupant's lap.
- **NEVER** ride with the seatback reclined when the vehicle is moving.
- Do not allow children to share a seat or seat belt.
- Do not wear the shoulder belt under your arm or behind your back.

- **NEVER** wear a seat belt over fragile objects. If there is a sudden stop or impact, the seat belt can damage it.
- Do not use the seat belt if it is twisted. A twisted seat belt will not protect you properly in an accident.
- Do not use a seat belt if the webbing or hardware is damaged.
- Do not latch the seat belt into the buckles of other seats.
- **NEVER** unfasten the seat belt while driving. This may cause loss of vehicle control resulting in an accident.
- Make sure there is nothing in the buckle interfering with the seat belt latch mechanism, because any materials in the buckle can cause the seat belt not to be fastened securely.
- No modifications or additions should be made by the user which will either prohibit the seat belt adjusting devices from operating to remove slack, or prohibit the seat belt assembly from being adjusted to remove slack.



WARNING

Damaged seat belts and seat belt assemblies will not operate properly. Always replace:

- Frayed, contaminated, or damaged webbing.
- Damaged hardware.
- The entire seat belt assembly after it has been worn in an accident, even if damage to webbing or assembly is not apparent.

Seat Belt Warning Light

Driver's seat belt warning



As a reminder to the driver, the driver's seat belt warning lights will illuminate for approximately 6 seconds each time the START/STOP button is in the ON position regardless of belt fastening. If the seatbelt is not fastened, the warning chime will sound for about 6 seconds.

If you start to drive without the seat belt fastened or you unfasten the seat belt when you drive under 12 mph (20 km/h) or stop, the corresponding warning light will illuminate.

If you start to drive without the seat belt fastened or you unfasten the seat belt when you drive 12 mph (20 km/h) and faster, the warning light will blink and warning chime will sound for approximately 100 seconds.

When the seat belt is unfastened during driving, the warning light will illuminate when the speed is under 12 mph (20 km/h).

When the speed is 12 mph (20 km/h) and faster, the warning light will blink and warning chime will sound for approximately 100 seconds.

Front passenger's seat belt warning

As a reminder to the front passenger, the front passenger's seat belt warning lights will illuminate for approximately 6 seconds each time the START/STOP button is in the ON position regardless of belt fastening.

If you start to drive without the seat belt fastened or you unfasten the seat belt when you drive under 12 mph (20 km/h) or stop, the corresponding warning light will illuminate.

If you start to drive without the seat belt fastened or you unfasten the seat belt when you drive 12 mph (20 km/h) and faster, the warning light will blink and warning chime will sound for approximately 100 seconds.

When the seat belt is unfastened during driving, the warning light will illuminate when the speed is under 12 mph (20 km/h). When the speed is 12 mph (20 km/h) and faster, the warning light will blink and warning chime will sound for approximately 100 seconds.



WARNING

Riding in an improper position adversely affects the front passenger's seat belt warning system. It is important for the driver to instruct the passenger to properly be seated as instructed in this manual.



Information

- Although the front passenger seat is not occupied, the seat belt warning light will blink or illuminate for 6 seconds.
- The front passenger's seat belt warning may operate when luggage is placed on the front passenger seat.

Seat Belt Restraint System

Lap/shoulder belt

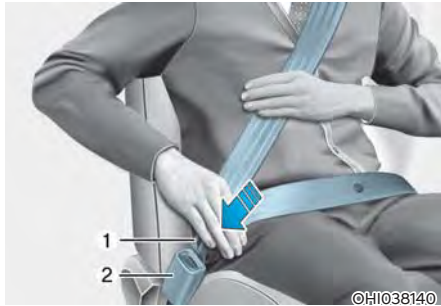

To fasten your seat belt:

Pull it out of the retractor and insert the metal tab (1) into the buckle (2). There will be an audible “click” when the tab locks into the buckle.

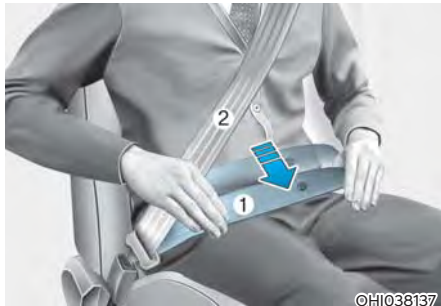

You should place the lap belt (1) portion across your hips and the shoulder belt (2) portion across your chest.

The seat belt automatically adjusts to the proper length after the lap belt portion is adjusted manually so that it fits snugly around your hips. If you lean forward in a slow, easy motion, the belt will extend and move with you.

If there is a sudden stop or impact, the belt will lock into position. It will also lock if you try to lean forward too quickly.

NOTICE

If you are not able to smoothly pull enough of the seat belt out from the retractor, firmly pull the seat belt out and release it. After release, you will be able to pull the belt out smoothly.

WARNING



Improperly positioned seat belts may increase the risk of serious injury in an accident. Take the following precautions when adjusting the seat belt:

- Position the lap portion of the seat belt as low as possible across your hips, not on your waist, so that it fits snugly. This allows your strong pelvic bones to absorb the force of the crash, reducing the chance of internal injuries.
- Position one arm under the shoulder belt and the other over the belt, as shown in the illustration.
- Always position the shoulder belt anchor into the locked position at the appropriate height.
- Never position the shoulder belt across your neck or face.

Height adjustment

You can adjust the height of the shoulder belt anchor to one of the four different positions for maximum comfort and safety.

The shoulder portion should be adjusted so it lies across your chest and midway over your shoulder nearest the door, not over your neck.

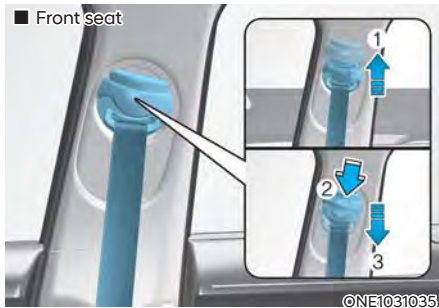

To adjust the height of the seat belt anchor, lower or raise the height adjuster into an appropriate position.

To raise the height adjuster, pull it up (1). To lower it, push it down (3) while pressing the height adjuster button (2).

Release the button to lock the anchor into position. Try sliding the height adjuster to make sure that it has locked into position.

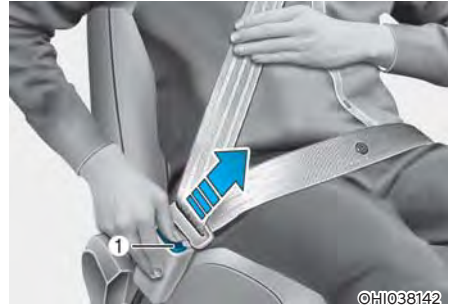

To release your seat belt:

Press the release button (1) in the locking buckle.

Once released, the belt should automatically draw back into the retractor. If this does not happen, check the belt to be sure it is not twisted, then try again.

Rear center seatbelt (3-point rear center seat belt)



When using the rear center seat belt, the buckle with the “CENTER” mark must be used.

i Information

If you are not able to pull out the safety belt from the retractor, firmly pull the belt out and release it. After release, you will be able to pull the belt out smoothly.

! WARNING

Make sure that the seatback is locked in place when using the rear center seat belt.

If not, the seatback may move when there is a sudden stop or collision, which could result in serious injury.

Pre-tensioner seat belt



Your vehicle is equipped with driver's and front passenger's Pre-tensioner Seat Belts (Retractor Pretensioner). The purpose of the pre-tensioner is to make sure the seat belts fit tightly against the occupant's body in certain frontal or side collision(s). The Retractor Pre-tensioner may be activated in certain crashes where the frontal collision(s) is severe enough.

When the vehicle stops suddenly, or if the occupant tries to lean forward too quickly, the seat belt retractor will lock into position. In certain frontal or side collision(s), the pre-tensioner will activate and pull the seat belt into tighter contact against the occupant's body.

(1) Retractor Pretensioner

The purpose of the retractor pre-tensioner is to make sure that the shoulder belts fit in tightly against the occupant's upper body in certain frontal or side collision(s).

If the system senses excessive tension on the driver or passenger's seat belt when the pre-tensioner system activates, the load limiter inside the retractor pre-tensioner will release some of the pressure on the affected seat belt.



WARNING

- **Always wear your seat belt and sit properly in your seat.**
- **Do not use the seat belt if it is loose or twisted. A loose or twisted seat belt will not protect you properly in an accident.**
- **Do not place anything near the buckle. This may adversely affect the buckle and cause it to function improperly.**
- **Always replace your pre-tensioners after activation or an accident.**
- **NEVER inspect, service, repair or replace the pre-tensioners yourself. Have the pre-tensioners inspected, serviced, repaired or replaced by an authorized HYUNDAI dealer.**
- **Do not hit the seat belt assemblies.**



WARNING

Do not touch the pre-tensioner seat belt assemblies for several minutes after they have been activated. When the pre-tensioner seat belt mechanism deploys during a collision, the pre-tensioner can become hot and can burn you.



CAUTION

Body work on the front area of the vehicle may damage the pre-tensioner seat belt system. Therefore, have the system serviced by an authorized HYUNDAI dealer.

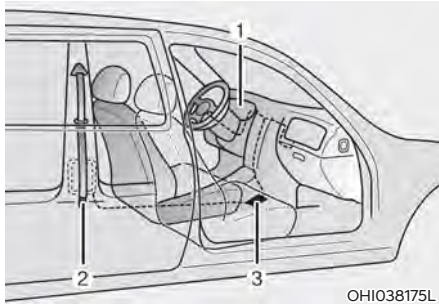

The Pre-Tensioner Seat Belt System consists mainly of the following components. Their locations are shown in the illustration above:

- (1) SRS air bag warning light
- (2) Retractor pre-tensioner
- (3) SRS control module

NOTICE

The sensor that activates the SRS control module is connected with the pre-tensioner seat belts. The SRS air bag warning light on the instrument cluster will illuminate for approximately 3~6 seconds after the Start/Stop button is in the ON position, and then it should turn off.

If the pre-tensioner is not working properly, the warning light will illuminate even if the SRS air bag is not malfunctioning. If the warning light does not illuminate, stays illuminated or illuminates when the vehicle is being driven, have the pre-tensioner seat belts and/or SRS control module be inspected by an authorized HYUNDAI dealer as soon as possible.

Information

- Pre-tensioner seat belts may be activated in certain frontal or side collisions or rollover situations (if equipped with rollover sensor).
- When the pre-tensioner seat belts are activated, a loud noise may be heard and fine dust, which may appear to be smoke, may be visible in the passenger compartment. These are normal operating conditions and are not hazardous.
- Although it is non-toxic, the fine dust may cause skin irritation and should not be inhaled for prolonged periods. Wash all exposed skin areas thoroughly after an accident in which the pre-tensioner seat belts were activated.

Additional Seat Belt Safety Precautions

Seat belt use during pregnancy

The seat belt should always be used during pregnancy. The best way to protect your unborn child is to protect yourself by always wearing the seat belt.

Pregnant women should always wear a lap-shoulder seat belt. Place the shoulder belt across your chest, routed between your breasts and away from your neck. Place the lap belt below your belly so that it fits **SNUGLY** across your hips and pelvic bone, under the rounded part of the belly.



WARNING

To reduce the risk of serious injury or death to an unborn child during an accident, pregnant women should NEVER place the lap portion of the seat belt above or over the area of the abdomen where the unborn child is located.

Seat belt use and children

Infant and small children

Most countries have Child Restraint System laws which require children to travel in approved Child Restraint System devices, including booster seats. The age at which seat belts can be used instead of Child Restraint System differs among countries, so you should be aware of the specific requirements in your country, and where you are travelling. Infant and Child Restraint System must be properly placed and installed in a rear seat.

For more information refer to the “Child Restraint Systems” section in this chapter.



WARNING

ALWAYS properly restrain infants and small children in a Child Restraint System appropriate for the child’s height and weight.

To reduce the risk of serious injury or death to a child and other passengers, NEVER hold a child in your lap or arms when the vehicle is moving. The violent forces created during an accident will tear the child from your arms and throw the child against the interior of the vehicle.

Small children are best protected from injury in an accident when properly restrained in the rear seat by a child restraint system that meets the requirements of the Federal Motor Vehicle Safety Standards. Before buying any child restraint system, make sure that it has a label certifying that it meets Federal Motor Vehicle Safety Standard FMVSS 213. The restraint must be appropriate for your child’s height and weight. Check the label on the child restraint for this information. Refer to the “Child Restraint Systems” section in this chapter.

Larger children

Children under age 13 and who are too large for a booster seat should always occupy the rear seat and use the available lap/shoulder belts. A seat belt should lie across the upper thighs and be snug across the shoulder and chest to restrain the child safely. Check belt fit periodically. A child's squirming could put the belt out of position. In the event of an accident, children are afforded the best safety restrained by a proper Child Restraint System in the rear seats.

If a larger child over age 13 must be seated in the front seat, the child must be securely restrained by the available lap/shoulder belt and the seat should be placed in the rearmost position.

If the shoulder belt portion slightly touches the child's neck or face, try placing the child closer to the center of the vehicle. If the shoulder belt still touches their face or neck, they need to be returned to an appropriate booster seat in the rear seat.



WARNING

- **Always make sure larger children's seat belts are worn and properly adjusted.**
- **NEVER allow the shoulder belt to contact the child's neck or face.**
- **Do not allow more than one child to use a single seat belt.**

Seat belt use and injured people

A seat belt should be used when an injured person is being transported. Consult a physician for specific recommendations.

One person per belt

Two people (including children) should never attempt to use a single seat belt. This could increase the severity of injuries in case of an accident.

Do not lie down

Sitting in a reclined position when the vehicle is in motion can be dangerous. Even when buckled up, the protections of your restraint system (seat belts and/or air bags) is greatly reduced by reclining your seatback.

Seat belts must be snug against your hips and chest to work properly.

During an accident, you could be thrown into the seat belt, causing neck or other injuries.

The more the seat back is reclined, the greater the chance for the passenger's hips to slide under the lap belt or the passenger's neck to strike the shoulder belt.



WARNING

- **NEVER ride with a reclined seatback when the vehicle is moving.**
- **Riding with a reclined seatback increases your chance of serious or fatal injuries in the event of a collision or sudden stop.**
- **Driver and passengers should always sit well back in their seats with the seatbacks upright and should be belted properly.**

Care of Seat Belts

Seat belt systems should never be disassembled or modified. In addition, care should be taken to assure that seat belts and belt hardware are not damaged by seat hinges, doors or other abuse.

Periodic inspection

All seat belts should be inspected periodically for wear or damage of any kind. Any damaged parts should be replaced as soon as possible.

Keep belts clean and dry

Seat belts should be kept clean and dry. If belts become dirty, they can be cleaned by using a mild soap solution and warm water. Bleach, dye, strong detergents or abrasives should not be used because they may damage and weaken the fabric.

When to replace seat belts

The entire seat belt assembly or assemblies should be replaced if the vehicle has been involved in an accident. This should be done even if no damage is visible. Consult an authorized HYUNDAI dealer.

CHILD RESTRAINT SYSTEM (CRS)

Children Always in the Rear



WARNING

Always properly restrain children in the rear seats of the vehicle. Children of all ages are safer when restrained in the rear seat. A child riding in the front passenger seat can be forcefully struck by an inflating air bag resulting in SERIOUS INJURY or DEATH.

Children under age 13 should always ride in the rear seats and must always be properly restrained to minimize the risk of injury in an accident, sudden stop or sudden maneuver.

According to accident statistics, children are safer when properly restrained in the rear seats than in the front seat. **Even with air bags, children can be seriously injured or killed.** Children too large for a Child Restraint System must use the seat belts provided.

All 50 states have child restraint laws which require children to travel in approved Child Restraint Systems.

The laws governing the age or height/weight restrictions at which seat belts can be used instead of Child Restraint System differs among states, so you should be aware of the specific requirements in your country, and where you are travelling.

Child Restraint Systems must be properly placed and installed in the rear seat. You must use a commercially available Child Restraint System that meets the requirements of the Federal Motor Vehicle Safety Standards (FMVSS 213).

Child Restraint Systems are generally designed to be secured in a vehicle seat by lap belt portion of a lap/shoulder belt, or by a LATCH system in the rear seats of the vehicle.

Child Restraint System (CRS)

Infants and younger children must be restrained in an appropriate rearward-facing or forward-facing CRS that has first been properly secured to the seat of the vehicle. Read and comply with the instructions for installation and use provided by the manufacturer of the Child Restraint System.



WARNING

An improperly secured child restraint can increase the risk of SERIOUS INJURY or DEATH in an accident. Always take the following precautions when using a Child Restraint System:

- **NEVER** install a child or infant restraint in the front passenger's seat.
- **Always properly secure the child restraint to a rear seat of the vehicle.**
- **Always follow the child restraint system manufacturer's instructions for installation and use.**
- **Always properly restrain your child in the child restraint.**
- **If the vehicle head restraint prevents proper installation of a child seat (as described in the child restraint system manual), the head restraint of the respective seating position shall be readjusted or entirely removed.**
- **Do not use an infant carrier or a child safety seat that "hooks" over a seatback, it may not provide adequate protection in an accident.**
- **After an accident, have an authorized HYUNDAI dealer check the child restraint system, seat belts, tether anchors and lower anchors.**

Selecting a Child Restraint System (CRS)

When selecting a Child Restraint System for your child, always:

- Make sure the Child Restraint System has a label certifying that it meets applicable Federal Motor Vehicle Safety Standards (FMVSS 213).
- Select a Child Restraint System based on your child's height and weight. The required label or the instructions for use typically provide this information.
- Select a Child Restraint System that fits the vehicle seating position where it will be used.
- Read and comply with the warnings and instructions for installation and use provided with the Child Restraint System.

Child Restraint System types

There are three main types of Child Restraint Systems: rearward-facing, forward-facing and booster Child Restraint Systems.

They are classified according to the child's age, height and weight.



Rearward-facing Child Restraint System

A rearward-facing Child Restraint System provides restraint with the seating surface against the back of the child. The harness system holds the child in place, and in an accident, acts to keep the child positioned in the Child Restraint Systems and reduce the stress to the fragile neck and spinal cord.

All children under the age of one year must always ride in a rearward-facing Child Restraint System. Convertible and 3-in-1 Child Restraint Systems typically have higher height and weight limits for the rearward-facing position, allowing you to keep your child rearward-facing for a longer period of time.

Keep using Child Restraint Systems in the rearward-facing position as long as children fit within the height and weight limits allowed by the Child Restraint System's manufacturer. It's the best way to keep them safe.

Once your child has outgrown the rearward-facing Child Restraint System, your child is ready for a forward-facing Child Restraint System with a harness.



WARNING

NEVER install a child or infant restraint in the front passenger's seat.

Placing a rearward-facing child restraint in the front seat can result in SERIOUS INJURY or DEATH if the child restraint is struck by an inflating air bag.



Forward-facing Child Restraint System

A forward-facing Child Restraint System provides restraint for the child's body with a harness. Keep children in a forward-facing Child Restraint System with a harness until they reach the top height or weight limit allowed by your Child Restraint System's manufacturer.

Once your child outgrows the forward-facing Child Restraint System, your child is ready for a booster seat.

Booster seats

A booster seat is a Child Restraint System designed to improve the fit of the vehicle's seat belt system. A booster seat positions the seat belt so that it fits properly over the stronger parts of your child's body. Keep your children in booster seats until they are big enough to fit in a seat belt properly.

For a seat belt to fit properly, the lap belt must lie comfortable across the upper thighs, not the stomach. The shoulder belt should lie comfortable across the shoulder and chest and not across the neck or face. Children under age 13 must always be properly restrained to minimize the risk of injury in an accident, sudden stop or sudden maneuver.

Installing a Child Restraint System (CRS)

WARNING

Before installing your Child Restraint System always:

Read and follow the instructions provided by the manufacturer of the Child Restraint System.

Failure to follow all warnings and instructions could increase the risk of the SERIOUS INJURY or DEATH if an accident occurs.

WARNING

If the vehicle head restraint prevents proper installation of a Child Restraint System, the head restraint of the respective seating position shall be readjusted or entirely removed.

After selecting a proper Child Restraint System for your child and checking that the Child Restraint System fits properly on the seating position, there are three general steps for a proper installation:

- **Properly secure the Child Restraint System to the vehicle.** All Child Restraint Systems must be secured to the vehicle with the lap belt or lap part of a lap/shoulder belt or with the lower anchor and/or tether anchor and/or with the support leg.

- **Make sure the Child Restraint System is firmly secured.** After installing a Child Restraint System to the vehicle, push and pull the seat forward and from side-to-side to verify that it is securely attached to the seat. A Child Restraint System secured with a seat belt should be installed as firmly as possible. However, some side-to-side movement can be expected.

When installing a Child Restraint System, adjust the vehicle seat and seatback (up and down, forward and rearward) so that your child fits in the Child Restraint System in a comfortable manner.

- **Secure the child in the Child Restraint System.** Make sure the child is properly strapped in the Child Restraint System according to the Child Restraint System manufacturer's instructions.



CAUTION

A Child Restraint System in a closed vehicle can become very hot. To prevent burns, check the seating surface and buckles before placing your child in the Child Restraint System.

Lower Anchors and Tether for Children (LATCH System)

The LATCH system holds a Child Restraint System during driving and in an accident. This system is designed to make installation of the Child Restraint System easier and reduce the possibility of improperly installing your Child Restraint System. The LATCH system uses anchors in the vehicle and attachments on the Child Restraint System. The LATCH system eliminates the need to use seat belts to secure the Child Restraint System to the rear seats.

Lower anchors are metal bars built into the vehicle. There are two lower anchors for each LATCH seating position that will accommodate a Child Restraint System with lower attachments.

To use the LATCH system in your vehicle, you must have a Child Restraint System with LATCH attachments.

The Child Restraint System manufacturer will provide you with instructions on how to use the Child Restraint System with its attachments for the LATCH anchorages.



LATCH anchors have been provided in the left and right outboard rear seating positions. Their locations are shown in the illustration. There are no LATCH anchors provided for the center rear seating position.

 **WARNING**

Do not attempt to install a Child Restraint System using LATCH anchors in the rear center seating position. There are no LATCH anchors provided for this seat. Using the outboard seat anchors can damage the anchors which may break or fail in a collision resulting in serious injury or death.

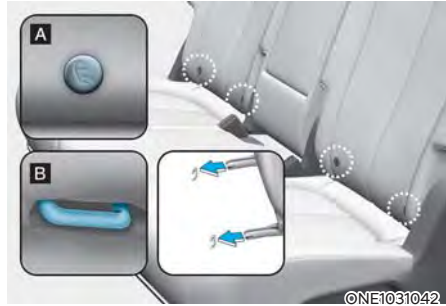

[A] : Lower Anchor Position Indicator
[B] : Lower Anchor

The lower anchor position indicator symbols are located on the left and right rear seat backs to identify the position of the lower anchors in your vehicle (see arrows in illustration).

The LATCH anchors are located between the seatback and the seat cushion of the rear seat left and right outboard seating positions.

 **WARNING**

Before installing the Child Restraint System, make sure that there are no objects (for example, toy, pen, wire) around the lower anchor area. Those objects may damage either the seat belt system or the Child Restraint System during the installment procedure. If necessary, have the vehicle inspected by an authorized HYUNDAI dealer.

Securing a Child Restraint System with the “LATCH Anchors System”

To install a LATCH-compatible Child Restraint System in either of the rear outboard seating positions:

1. Move the seat belt buckle away from the lower anchors.
2. Move any other objects away from the anchorages that could prevent a secure connection between the Child Restraint System and the lower anchors.
3. Place the Child Restraint System on the vehicle seat, then attach the seat to the lower anchors according to the instructions provided by the Child Restraint System manufacturer.
4. Follow the instructions of the Child Restraint System’s manufacturer for proper installation and connection of the lower attachments on the Child Restraint System to the lower anchors.



WARNING

Take the following precautions when using the LATCH system:

- **Read and follow all installation instructions provided with your Child Restraint System.**
- **To prevent the child from reaching and taking hold of unretracted seat belts, buckle all unused rear seat belts and retract the seat belt webbing behind the child. Children can be strangled if a shoulder belt becomes wrapped around their neck and the seat belt tightens.**
- **NEVER attach more than one Child Restraint System to a single anchorage. This could cause the anchor or attachment to come loose or break.**
- **Always have the LATCH system inspected by your dealer after an accident. An accident can damage the LATCH system and may not properly secure the Child Restraint System.**

NOTICE

The recommended weight for the LATCH system is under 65 lb. (30 kg).

How to determine an appropriate child restraint weight: Child weight + Child restraint system weight < 65 lb. (30kg)

Securing a Child Restraint System seat with “Tether Anchor” system

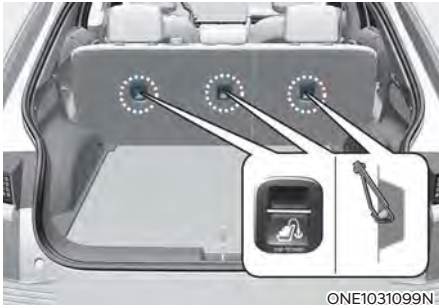

First secure the child restraint with the LATCH lower anchors or the seat belt. If the child restraint manufacturer recommends that the top tether strap be attached, attach and tighten the top tether strap to the top tether strap anchor.

Child restraint hook holders are located on the rear of the seatbacks.



To install the tether anchor:

1. Route the Child Restraint System top-tether strap over the seatback. Route the tether strap under the head restraint and between the head restraint posts, or route the tether strap over the top of the vehicle seatback. Make sure the strap is not twisted.
2. Connect the tether strap hook to the tether anchor, then tighten the top-tether strap according to the instructions of your Child Restraint System's manufacturer to firmly attach the Child Restraint System to the seat.
3. Check that the Child Restraint System is securely attached to the seat by pushing and pulling the seat forward-and-back and side-to-side.

**WARNING**

Take the following precautions when installing the top-tether:

- Read and follow all installation instructions provided with your Child Restraint System.
- **NEVER** attach more than one Child Restraint System to a single tether anchor. This could cause the anchorage or attachment to come loose or break.
- Do not attach the tether strap to anything other than the correct top-tether anchor. It may not work properly if attached to something else.
- Child Restraint System anchors are designed to withstand only those loads imposed by correctly fitted Child Restraint System.

Under no circumstances are the anchors to be used for adult seat belts or harnesses or for attaching other items or equipment to the vehicle.

Securing a Child Restraint System with a lap/shoulder belt**WARNING**

ALWAYS place a rearward-facing Child Restraint System in the rear seat of the vehicle.

Placing a rearward-facing child restraint in the front seat can result in serious injury or death if the Child Restraint System is struck by an inflating air bag.

When not using the LATCH system, all Child Restraint Systems must be secured to a rear seat with the lap part of a lap/shoulder belt.



Automatic locking mode

Since all passenger seat belts move freely under normal conditions and only lock under extreme or emergency conditions (emergency locking mode), you must manually pull the seat belt all the way out to shift the retractor to the "Automatic Locking" mode to secure a Child Restraint System.

The "Automatic Locking" mode will help prevent the normal movement of the child in the vehicle from causing the seat belt to loosen and compromise the Child Restraint System. To secure a Child Restraint System, use the following procedure.

To install a Child Restraint System on the rear seats, do the following:

1. Place the Child Restraint System on a rear seat and route the lap/shoulder belt around or through the Child Restraint System, following the Child Restraint System manufacturer's instructions. Make sure the seat belt webbing is not twisted.

i Information

When using the rear center seat belt, you should also refer to the "Rear Seat Belt – Passenger's 3-point system" section in this chapter.

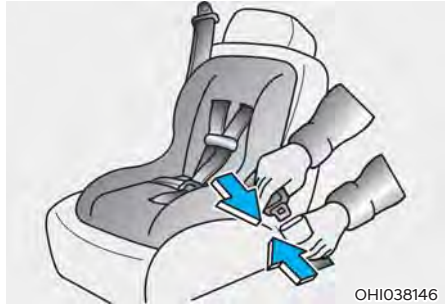

2. Fasten the lap/shoulder belt latch into the buckle. Listen for the distinct "click" sound.

i Information

Position the release button so that it is easy to access in case of an emergency.



3. Pull the shoulder portion of the seat belt all the way out. When the shoulder portion of the seat belt is fully extended, it will shift the retractor to the "Automatic Locking" (child restraint) mode.



OHIO38148

4. Slowly allow the shoulder portion of the seat belt to retract and listen for an audible "clicking" or "ratcheting" sound. This indicates that the retractor is in the "Automatic Locking" mode. If no distinct sound is heard, repeat steps 3 and 4.
5. Remove as much slack from the belt as possible by pushing down on the Child Restraint System while feeding the shoulder belt back into the retractor.
6. Push and pull on the Child Restraint System to confirm that the seat belt is holding it firmly in place. If it is not, release the seat belt and repeat steps 2 through 6.
7. Double check that the retractor is in the "Automatic Locking" mode by attempting to pull more of the seat belt out of the retractor. If you cannot, the retractor is in the "Automatic Locking" mode.

If your Child Restraint System manufacturer instructs or recommends you to use a tether anchor with the lap/shoulder belt, refer to the previous pages for more information.

i Information

When the seat belt is allowed to retract to its fully stowed position, the retractor will automatically switch from the "Automatic Locking" mode to the emergency lock mode for normal adult usage.

! WARNING

If the retractor is not in the "Automatic Locking" mode, the child restraint can move when your vehicle turns or stops suddenly. A child can be seriously injured or killed if the child restraint is not properly anchored in the car, including manually pulling the seat belt all the way out to shift the retractor to the "Automatic Locking" mode.

To remove the Child Restraint System, press the release button on the buckle and then pull the lap/shoulder belt out of the Child Restraint System and allow the seat belt to retract fully.

AIR BAG - SUPPLEMENTAL RESTRAINT SYSTEM

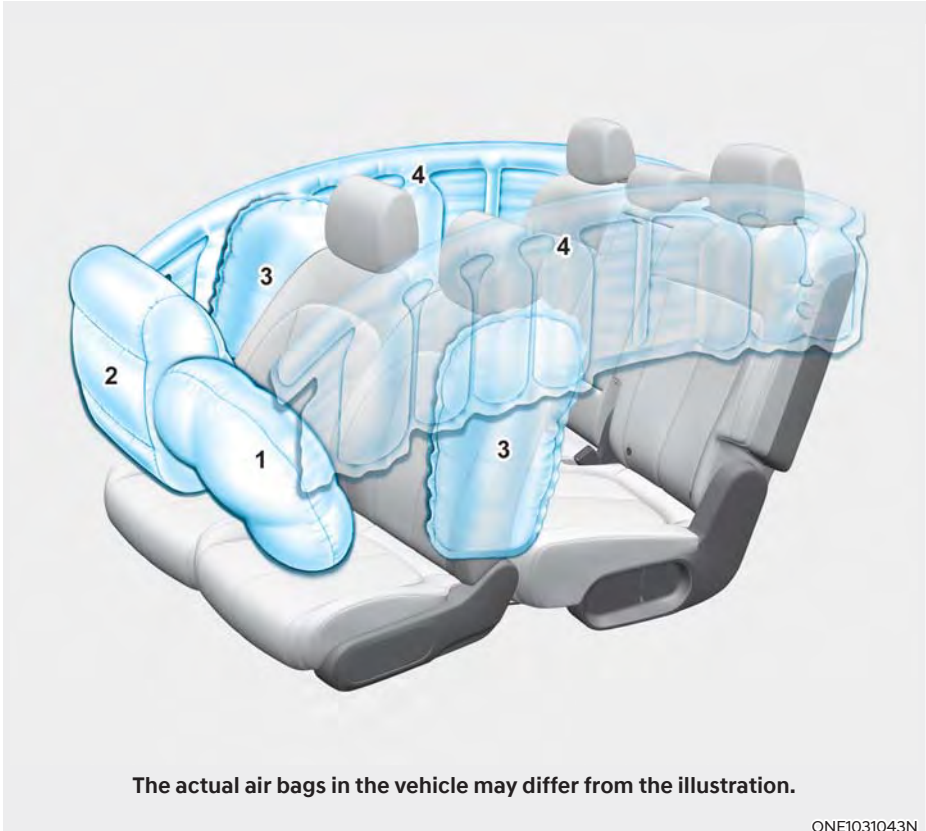

1. Driver's front air bag
2. Passenger's front air bag

3. Side air bag
4. Curtain air bag

The vehicles are equipped with a Supplemental Air Bag System for the driver's seat and front passenger's seats.

The front air bags are designed to supplement the three-point seat belts. For these air bags to provide protection, the seat belts must be worn at all times when driving.

You can be severely injured or killed in an accident if you are not wearing a seat belt. Air bags are designed to supplement seat belts, but do not replace them. Also, air bags are not designed to deploy in every collision. In some accidents, the seat belts are the only restraint protecting you.



WARNING

AIR BAG SAFETY PRECAUTIONS

ALWAYS use seat belts and Child Restraint Systems - every trip, every time, everyone! Even with air bags, you can be seriously injured or killed in a collision if you are improperly belted or not wearing your seat belt when the air bag inflates.

NEVER place a child in any Child Restraint System or booster seat in the front passenger seat, unless the air bag is deactivated.

An inflating air bag could forcefully strike the infant or child causing serious or fatal injuries.

ABC - Always Buckle Children under age 13 in the back seat. It is the safest place for children of any age to ride. If a child age 13 or older must be seated in the front seat, he or she must be properly belted and the seat should be moved as far back as possible.

All occupants should sit upright with the seatback in an upright position, centered on the seat cushion with their seat belt on, legs comfortably extended and their feet on the floor until the vehicle is parked and the vehicle is turned off. If an occupant is out of position during an accident, the rapidly deploying air bag may forcefully contact the occupant causing serious or fatal injuries.

You and your passengers should never sit or lean unnecessarily close to the air bags or lean against the door or center console.

Move your seat as far back as possible from front air bags, while still maintaining control of the vehicle. The U.S. National Highway Traffic Safety Administration (NHTSA) recommends that drivers allow at least 10 inches (25 cm) between the center of the steering wheel and the chest.

Where are the Air Bags?

Driver's and passenger's front air bags



■ Passenger's front air bag



Your vehicle is equipped with a Supplemental Restraint System (SRS) and lap/shoulder belts at both the driver and passenger seating positions.

The SRS consists of air bags which are located in the center of the steering wheel and the passenger's side front panel pad above the glove box.

The air bags are labeled with the letters "AIR BAG" embossed on the pad covers.

The purpose of the SRS is to provide the vehicle's driver and front passengers with additional protection than that offered by the seat belt system alone in case of a frontal impact of sufficient severity.

The seat belt buckle sensors determine if the driver and front passenger's seat belts are fastened. These sensors provide the ability to control the SRS deployment based on whether or not the seat belts are fastened, and how severe the impact is.

The advanced SRS offers the ability to control the air bag inflation within two levels. A first stage level is provided for moderate-severity impacts. A second stage level is provided for more severe impacts.

According to the impact severity, and seat belt usage, the SRS Control Module (SRSCM) controls the air bag inflation. Failure to properly wear seat belts can increase the risk or severity of injury in an accident.

WARNING

To reduce the risk of serious injury or death from inflating front air bags, take the following precautions:

- **Seat belts must be worn at all times to help keep occupants positioned properly.**
- **Move your seat as far back as possible from front air bags, while still maintaining control of the vehicle.**
- **Never lean against the door or center console.**
- **Do not allow the front passenger to place their feet or legs on the dashboard.**
- **No objects (such as crash pad cover, mobile phone holder, cup holder, perfume or stickers) should be placed over or near the air bag modules on the steering wheel, instrument panel, windshield glass, and the front passenger's panel above the glove box. Such objects could cause harm if the vehicle is in a crash severe enough to cause the air bags to deploy.**
- **Do not attach any objects on the front windshield and inside mirror.**

Side air bags (if equipped)

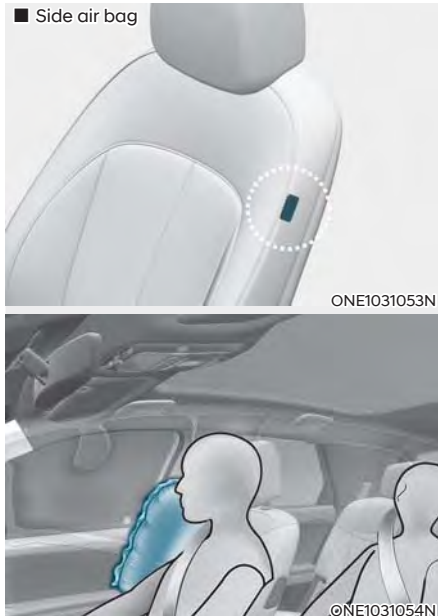

Your vehicle is equipped with a side air bag in each front seat. The purpose of the air bag is to provide the vehicle's driver and the front passenger with additional protection than that offered by the seat belt alone.

The side air bags are designed to deploy during certain side impact collisions, depending on the crash severity, angle, speed and point of impact.

The side air bags on both sides of the vehicle are designed to deploy when a rollover is detected by a rollover sensor. (if equipped with rollover sensor)

The side air bags are not designed to deploy in all side impact or rollover situations.

The side air bags are designed to deploy during certain side impact collisions, depending on the crash severity.

For vehicles equipped with a rollover sensor the side and/or curtain air bags and pre-tensioners on both sides of the vehicle may deploy if a rollover or possible rollover is detected.

The side air bags are not designed to deploy in all side impact or rollover situations.

WARNING

To reduce the risk of serious injury or death from an inflating side air bag, take the following precautions:

- **Seat belts must be worn at all times to help keep occupants positioned properly.**
- **Do not allow passengers to lean their heads or bodies onto doors, put their arms on the doors, stretch their arms out of the window, or place objects between the doors and seats.**
- **Hold the steering wheel at the 9 o'clock and 3 o'clock positions, to minimize the risk of injuries to your hands and arms.**
- **Do not use any accessory seat covers. This could reduce or prevent the effectiveness of the system.**
- **Do not hang other objects except clothes. In an accident it may cause vehicle damage or personal injury especially when air bag is inflated.**

- Do not place any objects over the air bag or between the air bag and yourself. Also, do not attach any objects around the area the air bag inflates such as the door, side door glass, front and rear pillar.
- Do not place any objects between the door and the seat. They may become dangerous projectiles if the side air bag inflates.
- Do not install any accessories on the side or near the side air bags.
- Do not cause impact to the doors when the Start/Stop button is in the ON or START position as this may cause the side air bags to inflate.
- If the seat or seat cover is damaged, have the system serviced by an authorized HYUNDAI dealer.

Curtain air bags

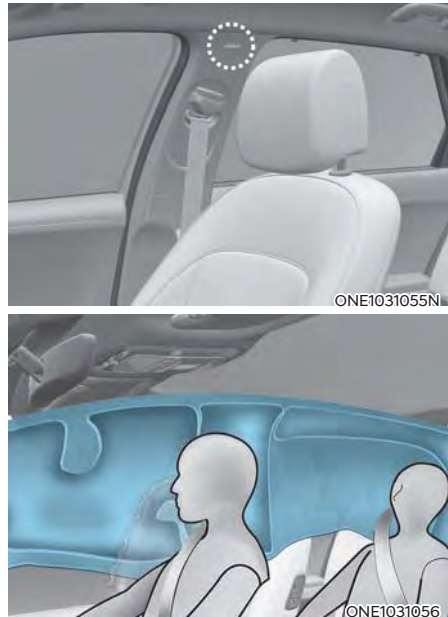

Curtain air bags are located along both sides of the roof rails above the front and rear doors.

They are designed to help protect the heads of the front seat occupants and the rear outboard seat occupants in certain side impact collisions.

The curtain air bags are designed to deploy during certain side impact collisions, depending on the crash severity.

For vehicles equipped with a rollover sensor the side and/or curtain air bags and pre-tensioners on both sides of the vehicle may deploy if a rollover or possible rollover is detected.

The curtain air bags are not designed to deploy in all side impact or rollover situations.



WARNING

To reduce the risk of serious injury or death from an inflating curtain air bag, take the following precautions:

- All seat occupants must wear seat belts at all times to help keep occupants positioned properly.
- Properly secure Child Restraint System as far away from the door as possible.
- Do not place any objects over the air bag. Also, do not attach any objects around the area the air bag inflates such as the door, side door glass, front and rear pillar, roof side rail.
- Do not hang other objects except clothes, especially hard or breakable objects.

In an accident, it may cause vehicle damage or personal injury.

- Do not allow passengers to lean their heads or bodies onto doors, put their arms on the doors, stretch their arms out of the window, or place objects between the doors and seats.
- Do not attempt to open or repair the side curtain airbags yourself. If necessary, have the air bag inspected by an authorized HYUNDAI dealer.

How does the Air Bags System Operate?

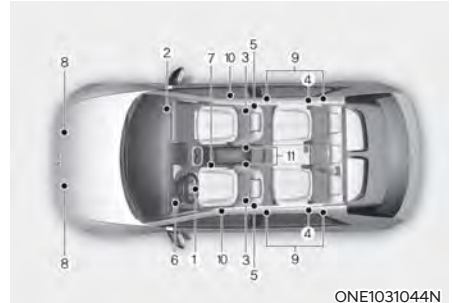

The SRS consists of the following components:

- (1) Driver's front air bag module
- (2) Passenger's front air bag module
- (3) Side air bag modules
- (4) Curtain air bag modules
- (5) Front retractor pre-tensioner
- (6) Air bag warning light
- (7) SRS control module (SRSCM) / Rollover sensor
- (8) Front impact sensors
- (9) Side impact sensors (acceleration)
- (10) Side impact sensors (pressure)
- (11) Driver's and front passenger's seat belt buckle sensors.

The SRSCM (Supplemental Restraint System Control Module) continually monitors all SRS components while the Start/Stop button is ON to determine if a crash impact is severe enough to require air bag deployment or pre-tensioner seat belt deployment.



SRS warning light

The SRS (Supplemental Restraint System) air bag warning light on the instrument panel displays the air bag symbol depicted in the illustration. The system checks the air bag electrical system for malfunctions. The light indicates that there is a potential problem with your air bag system, which could include your side and/or curtain air bags used for rollover protection (if equipped with rollover sensor).



WARNING

If your SRS malfunctions, the air bag may not inflate properly during an accident increasing the risk of serious injury or death.

If any of the following conditions occur, your SRS is malfunctioning:

- **The light does not turn on for approximately three to six seconds when the Start/Stop button is in the ON position.**
- **The light stays on after illuminating for approximately three to six seconds.**
- **The light comes on while the vehicle is in motion.**
- **The light blinks when the vehicle is running.**

Have an authorized HYUNDAI dealer inspect the SRS as soon as possible if any of these conditions occur.

During a moderate to severe frontal collision, sensors will detect the vehicle's rapid deceleration. If the rate of deceleration is high enough, the control unit will inflate the front air bags, at the time and with the force needed.

The front air bags help protect the driver and front passenger by responding to frontal impacts in which seat belts alone cannot provide adequate restraint. When needed, the side air bags help provide protection in the event of a side impact or rollover by supporting the side upper body area.

- Air bags are activated (able to inflate if necessary) only when the Start/Stop button is in the ON or START position, and it can be activated within about 3 minutes after the vehicle is turned off.
- Air bags inflate in the event of certain frontal or side collisions to help protect the occupants from serious physical injury.
- Generally, air bags are designed to inflate based upon the severity of a collision, its direction, or etc. These two factors determine whether the sensors produce an electronic deployment/inflation signal.
- The front air bags will completely inflate and deflate in an instant. It is virtually impossible for you to see the air bags inflate during an accident. It is much more likely that you will simply see the deflated air bags hanging out of their storage compartments after the collision.

- In addition to inflating in serious side collisions, vehicles equipped with a rollover sensor, side and/or curtain air bags will inflate if the sensing system detects a rollover.

When a rollover is detected, curtain air bags will remain inflated longer to help provide protection from ejection, especially when used in conjunction with the seat belts. (if equipped with a rollover sensor)

- To help provide protection, the air bags must inflate rapidly. The speed of air bag inflation is a consequence of extremely short time in which to inflate the air bag between the occupant and the vehicle structures before the occupant impacts those structures. This speed of inflation reduces the risk of serious or life-threatening injuries and is thus a necessary part of air bag design. However, the rapid air bag inflation can also cause injuries which can include facial abrasions, bruises and broken bones because the inflation speed also causes the air bags to expand with a great deal of force.
- There are even circumstances under which contact with the air bag can cause fatal injuries, especially if the occupant is positioned excessively close to the air bag.

You can take steps to reduce the risk of being injured by an inflating air bag. The greatest risk is sitting too close to the air bag. An air bag needs about 10 in. (25 cm) of space to inflate. NHTSA recommends that drivers allow at least 10 in. (25 cm) between the center of the steering wheel and the chest.



WARNING

To reduce the risk of serious injury or death from an inflating air bag, take the following precautions:

- **NEVER** place a child restraint in the front passenger seat.
Always properly restrain children under age 13 in the rear seats of the vehicle.
- **Adjust the front passenger's and driver's seats as far to the rear as possible while allowing you to maintain full control of the vehicle.**
- **Hold the steering wheel with hands at the 9 o'clock and 3 o'clock positions.**
- **Never place anything or anyone between the air bag and the seat occupant.**
- **Do not allow the front passenger to place their feet or legs on the dashboard.**

■ Driver's front air bag (1)



When the SRSCM detects a sufficiently severe impact to the front of the vehicle, it will automatically deploy the front air bags.

■ Driver's front air bag (2)



Upon deployment, tear seam molded directly into the pad cover will separate under pressure from the expansion of the air bags. Further opening of the covers allows full inflation of the air bags.

A fully inflated air bag, in combination with a properly worn seat belt, slows the driver's or the front passenger's forward motion, reducing the risk of head and chest injury.

■ Driver's front air bag (3)

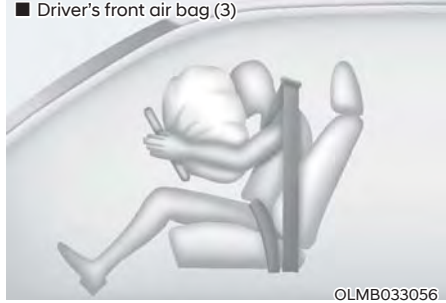

■ Passenger's front air bag



After complete inflation, the air bag immediately starts deflating, enabling the driver to maintain forward visibility and the ability to steer or operate other controls.

WARNING

To prevent objects from becoming dangerous projectiles when the passenger's air bag inflates:

- **Do not install or place any objects (drink holder, CD holder, stickers, etc.) on the front passenger's panel above the glove box where the passenger's air bag is located.**
- **Do not install a container of liquid air freshener near the instrument cluster or on the instrument panel surface.**

What to Expect After an Air Bag Inflates

After a frontal or side air bag inflates, it will deflate very quickly. Air bag inflation will not prevent the driver from seeing out of the windshield or being able to steer. Curtain air bags may remain partially inflated for some time after they deploy.



WARNING

After an air bag inflates, take the following precautions:

- **Open your windows and doors as soon as possible after impact to reduce prolonged exposure to the smoke and powder released by the inflating air bag.**
- **Do not touch the air bag storage area's internal components immediately after an air bag has inflated. The parts that come into contact with an inflating air bag may be very hot.**
- **Always wash exposed skin areas thoroughly with cold water and mild soap.**
- **Have an authorized HYUNDAI dealer replaced the air bag immediately after deployment. Air bags are designed to be used only once.**

Noise and smoke from inflating air bag

When the air bags inflate, they make a loud noise and may produce smoke and powder in the air inside of the vehicle. This is normal and is a result of the ignition of the air bag inflator. After the air bag inflates, you may feel substantial discomfort in breathing because of the contact of your chest with both the seat belt and the air bag, as well as from breathing the smoke and powder. The powder may aggravate asthma for some people. If you experience breathing problems after an air bag deployment, seek medical attention immediately.

Though the smoke and powder are nontoxic, they may cause irritation to the skin, eyes, nose, throat, etc. If this is the case, wash and rinse with cold water immediately and seek medical attention if the symptoms persist.

Occupant Classification System (OCS)



Your vehicle is equipped with an Occupant Classification System (OCS) in the front passenger's seat.

Main components of the Occupant Classification System

- A detection device located within the front passenger seat cushion.
- Electronic system to help determine whether the passenger air bag systems should be activated or deactivated.
- An indicator light located on the overhead console which illuminates the words "PASSENGER AIR BAG OFF" indicating the front passenger air bag system is deactivated.
- The overhead console air bag indicator light is interconnected with the OCS.

The OCS is designed to help detect the presence of a properly-seated front passenger and determine if the passenger's front air bag should be enabled (may inflate) or not.

The purpose is to help reduce the risk of injury or death from an inflating air bag to certain front passenger seat occupants, such as children, by requiring the air bag to be automatically turned OFF.

For example, if a child restraint of the type specified in the regulations is on the seat, the occupant classification sensor can detect it and cause the air bag to turn OFF.

Front passenger seat adult occupants who are properly seated and wearing the seat belt properly, should not cause the passenger air bag to be automatically turned OFF. For smaller adults it may turn OFF, however, if the occupant does not sit in the seat properly (for example, by not sitting upright, by sitting on the edge of the seat, or by otherwise being out of position), this could cause the sensor to turn the air bag OFF.

You will find the "PASSENGER AIR BAG OFF" indicator on the overhead console panel. This system detects the conditions 1-4 in the following table and activates or deactivates the front passenger air bag based on these conditions.

Always be sure that you and all vehicle occupants are seated properly and wearing the seat belt properly for the most effective protection by the air bag and the seat belt.

The OCS may not function properly if the passenger takes actions which can affect the classification system. These include:

- Failing to sit in an upright position.
- Leaning against the door or center console.
- Sitting towards the sides of the front of the seat.
- Putting their legs on the dashboard or resting them on other locations which reduce the passenger weight on the front seat.
- Wearing the seat belt improperly.
- Reclining the seatback.
- Wearing thick clothes like ski wear or hip protection wear.
- Putting an additional thick cushion on the seat.
- Putting electrical devices (for example, notebook, satellite radio) on the seat with inverter charging.

Condition and operation in the front passenger Occupant Classification System

Condition detected by the occupant classification system	Indicator/Warning light		Devices
	“PASSENGER AIR BAG OFF” indicator light	SRS warning light	Front passenger air bag
1. Adult*1	Off	Off	Activated
2. Infant**2 or child restraint system with 12 months old *3*4	On	Off	Deactivated
3. Unoccupied	On	Off	Deactivated
4. Malfunction in the system	Off	On	Activated

*1: The system judges a person of adult size as an adult. When a smaller adult sits in the front passenger seat, the system may recognize him/her as a child depending on his/her physique and posture.

*2: Do not allow children to ride in the front passenger seat. When a larger child who has outgrown a child restraint system sits in the front passenger seat, the system may recognize him/her as an adult depending upon his/her physique or sitting position.

*3: Never install a child restraint system on the front passenger seat.

*4: The PASSENGER AIR BAG “OFF” indicator may turn on or off when a child above 12 months to 12 years old (with or without child restraint system) sits in the front passenger seat. This is a normal condition.

 **WARNING**

Riding in an improper position or placing weight on the front passenger's seat when it is unoccupied by a passenger adversely affects the OCS. To reduce the risk of serious injury or death:



- **NEVER** put a heavy load in the front seat or seatback pocket, or hang any items on the front passenger seat.



- **NEVER** place your feet on the front passenger seatback.



- **NEVER** sit with your hips shifted towards the front of the seat.



- **NEVER** ride with the seatback reclined when the vehicle is moving.



- **NEVER** place your feet or legs on the dashboard.



- **NEVER** lean on the door or center console or sit on one side of the front passenger seat.



- Do not sit on the passenger seat wearing heavily padded clothes such as ski wear and hip protector.



- Do not use car seat accessories such as thick blankets and cushions which cover up the car seat surface.



- Do not place electronic devices such as laptops, DVD player, or conductive materials such as water bottles on the passenger seat.
- Do not use electronic devices such as laptops and satellite radios which use inverter chargers.



- If large quantity of liquid has been spilled on the passenger seat, the air bag warning light may illuminate or malfunction.
Therefore, make sure the seat has been completely dried before driving the vehicle.

- Do not place sharp objects on the front passenger seat. These may damage the occupant detection system, if they puncture the seat cushion.
- Do not place any items under the front passenger seat.
- When changing or replacing the seat or seat cover, use original items only. The OCS has been developed based on using original HYUNDAI car seats only. Altering or changing the authentic parts may result in system malfunction and increase risk of injury when in collision. Any of the above could interfere with the proper operation of the OCS sensor thereby increasing the risk of an injury in an accident.



Proper seated position for OCS

If the “PASSENGER AIR BAG OFF” indicator is on when an adult is seated in the front passenger seat, place the Start/Stop button in the OFF position and ask the passenger to sit properly (sitting upright with the seat back in an upright position, centered on the seat cushion with their seat belt on, legs comfortably extended and their feet on the floor). Restart the vehicle and have the person remain in that position. This will allow the system to detect the person and to enable the passenger air bag. If the “PASSENGER AIR BAG OFF” indicator is still on, ask the passenger to move to the rear seat.

WARNING

NEVER allow an adult passenger to ride in the front passenger seat when the “PASSENGER AIR BAG OFF” indicator is illuminated. During a collision, the air bag will not inflate if the indicator is illuminated. Have your passenger reposition themselves in the seat. If the “PASSENGER AIR BAG OFF” indicator remains illuminated after the passenger repositions themselves properly and the vehicle is restarted, have the passenger move to the rear seat because the air bag will not inflate.

NOTICE

The “PASSENGER AIR BAG OFF” indicator generally illuminates for approximately 4 seconds after the Start/Stop button is in the ON or START position. But, if the START/STOP button is pressed to the ON or START position within 3 minutes after the vehicle is turned OFF, the indicator does not illuminate. If the front passenger seat is occupied, the OCS will then classify the front passenger after several more seconds.

Do not install a Child Restraint System on the Front Passenger's Seat



Even though your vehicle is equipped with the OCS, never install a child restraint in the front passenger's seat. An inflating air bag can forcefully strike a child or child restraint resulting in serious or fatal injury.



WARNING

NEVER use a rearward facing Child Restraint on a seat protected by an **ACTIVE AIRBAG** in front of it, **DEATH** or **SERIOUS INJURY** to the **CHILD** can occur.

Why didn't my air bag go off in a collision?

There are certain types of accidents in which the air bag would not be expected to provide additional protection. These include rear impacts, second or third collisions in multiple impact accidents, as well as low speed impacts. Damage to the vehicle indicates a collision energy absorption, and is not an indicator of whether or not an air bag should have inflated.

Air bag collision sensors



WARNING

To reduce the risk of an air bag deploying unexpectedly and causing serious injury or death:

- Do not hit or allow any objects to impact the locations where air bags or sensors are installed.
- Do not perform maintenance on or around the air bag sensors. If the location or angle of the sensors is altered, the air bags may deploy when they should not or may not deploy when they should.
- Installing bumper guards with non-genuine Hyundai or non-equivalent parts may adversely affect the collision and airbag deployment performance.

To ensure correct function of the airbag system, have the bumper replaced with genuine Hyundai part or the equivalent (of the genuine part) specified for your vehicle.

- Press the Start/Stop button to the **OFF** or **ACC** position and wait for 3 minutes when the vehicle is being towed to prevent inadvertent air bag deployment.
- Have all air bag repairs conducted by an authorized **HYUNDAI** dealer.



- | | |
|--|---|
| <p>1. SRS control module / Rollover sensor</p> <p>2. Front impact sensor</p> <p>3. Side impact sensor (Pressure)</p> | <p>4. Side impact sensor (Acceleration)</p> <p>5. Side impact sensor (Acceleration)</p> |
|--|---|

Air bag inflation conditions



Front air bags

Front air bags are designed to inflate in a frontal collision depending on the severity of impact of the front collision.



Side and curtain air bags

Side and curtain air bags are designed to inflate when an impact is detected by side collision sensors depending on the severity of impact resulting from a side impact collision.

Although the driver's and front passenger's air bags are designed to inflate in frontal collisions, they also may inflate in other types of collisions if the front impact sensors detect a sufficient impact. Side and curtain air bags are designed to inflate in side impact collisions, but they may inflate in other collisions if the side impact sensors detect a sufficient impact.

Also, the side and curtain air bags are designed to inflate when a rollover is detected by a rollover sensor (if equipped with rollover sensor).

If the vehicle chassis is impacted by bumps or objects on unimproved roads, the air bags may deploy. Drive carefully on unimproved roads or on surfaces not designed for vehicle traffic to prevent unintended air bag deployment.

Air bag non-inflation conditions



In certain low-speed collisions the air bags may not deploy. The air bags are designed not to deploy in such cases because they may not provide benefits beyond the protection of the seat belts.



Front air bags are not designed to inflate in rear collisions, because occupants are moved backward by the force of the impact. In this case, inflated air bags would not provide any additional benefit.



Front air bags may not inflate in side impact collisions, because occupants move in the direction of the collision, and thus in side impacts, front air bag deployment would not provide additional occupant protection.

However, side and curtain air bags may inflate depending on the severity of impact.

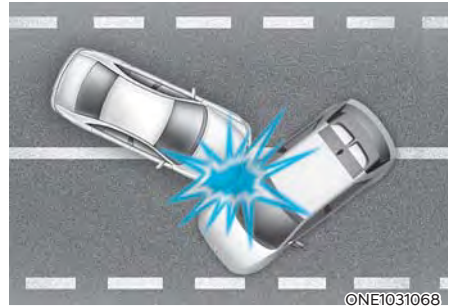

In an angled collision, the force of impact may direct the occupants in a direction where the air bags would not be able to provide any additional benefit, and thus the sensors may not deploy any air bags.

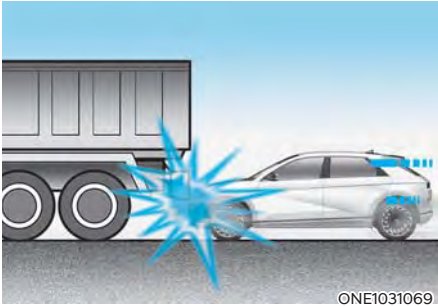

Just before impact, drivers often brake heavily. Such heavy braking lowers the front portion of the vehicle causing it to “ride” under a vehicle with a higher ground clearance. Air bags may not inflate in this “underride” situation because deceleration forces that are detected by sensors may be significantly reduced by such “underride” collisions.

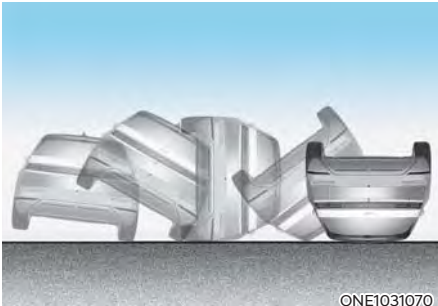

Front air bags may not inflate in rollover accidents because front air bag deployment would not provide additional occupant protection.

i Information

With rollover sensor

The side and curtain air bags may inflate in a rollover situation, when it is detected by the rollover sensor.

i Information

Without rollover sensor

The side and/or curtain air bags may inflate when the vehicle is rolled over by a side impact collision, if the vehicle is equipped with side and/or curtain air bags.

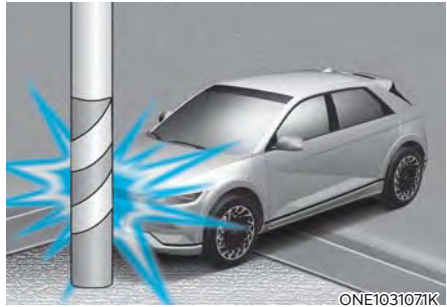

Air bags may not inflate if the vehicle collides with objects such as utility poles or trees, where the point of impact is concentrated and the collision energy is absorbed by the vehicle structure.

SRS Care

The SRS is virtually maintenance-free and there are no parts you can safely service by yourself. If the SRS air bag warning light does not illuminate when the Start/Stop button is in the ON position, or continuously remains on, have the system be immediately inspected by an authorized HYUNDAI dealer.

We recommend any work on the SRS system, such as removing, installing, repairing, or any work on the steering wheel, the front passenger's panel, front seats and roof rails be performed by an authorized HYUNDAI dealer. Improper handling of the SRS system may result in serious personal injury.



WARNING

To reduce the risk of serious injury or death take the following precautions:

- **Do not attempt to modify or disconnect the SRS components or wiring, including the addition of any kind of badges to the pad covers or modifications to the body structure.**
- **Do not place objects over or near the air bag modules on the steering wheel, instrument panel, and the front passenger's panel above the glove box.**
- **Clean the air bag pad covers with a soft cloth moistened with plain water. Solvents or cleaners could adversely affect the air bag covers and proper deployment of the system.**
- **Have the inflated air bags be replaced by an authorized HYUNDAI dealer.**
- **If components of the air bag system must be discarded, or if the vehicle must be scrapped, certain safety precautions must be observed. Consult an authorized HYUNDAI dealer for the necessary information. Failure to follow these precautions could increase the risk of personal injury.**

Additional Safety Precautions

Passengers should not move out of or change seats while the vehicle is moving. A passenger who is not wearing a seat belt during a crash or emergency stop can be thrown against the inside of the vehicle, against other occupants, or be ejected from the vehicle.

Do not use any accessories on seat belts. Devices claiming to improve occupant comfort or reposition the seat belt can reduce the protection provided by the seat belt and increase the chance of serious injury in a crash.

Do not modify the front seats. Modification of the front seats could interfere with the operation of the supplemental restraint system sensing components or side air bags.

Do not place items under the front seats. Placing items under the front seats could interfere with the operation of the supplemental restraint system sensing components and wiring harnesses.

Do not cause impact to the doors. Impact to the doors when the Start/Stop button is in the ON or START position may cause the air bags to inflate.

Modifications to accommodate disabilities. If you require modification to your vehicle to accommodate a disability, contact the HYUNDAI Customer Connect Center at 800-633-5151.

Adding equipment to or modifying your air bag equipped vehicle

If you modify your vehicle by changing your vehicle's frame, bumper system, front end or side sheet metal or ride height, this may affect the operation of your vehicle's air bag system.

Air Bag Warning Labels



Air bag warning labels, required by the U.S. National Highway Traffic Safety Administration (NHTSA), are attached to alert the driver and passengers of potential risks of the air bag system. Be sure to read all of the information about the air bags that are installed on your vehicle in this Owners Manual.

4. Instrument Cluster

Instrument Cluster	4-4
Instrument Cluster Control.....	4-5
Instrument panel illumination.....	4-5
Gauges and Meters	4-5
Speedometer	4-5
Power/Charge Gauge	4-6
State of Charge (SOC) Gauge for High Voltage Battery	4-6
Outside temperature gauge.....	4-7
Odometer	4-8
Distance to empty	4-8
Reduction Gear Shift Indicator.....	4-9
Regenerative braking level indicator.....	4-9
Warning and Indicator Lights	4-9
Ready indicator	4-9
Service warning light	4-9
Power down indicator light	4-10
Charging connector indicator light	4-10
High voltage battery level warning light	4-10
Seat belt warning light	4-10
Air bag warning light	4-11
Regenerative brake warning light.....	4-11
Parking brake & brake fluid warning light	4-11
Anti-lock Brake System (ABS) warning light	4-12
Electronic Brake Force Distribution (EBD) system warning light	4-12
Motor Driven Power Steering (MDPS) warning light.....	4-13
Master warning light.....	4-13
Electronic Parking Brake (EPB) warning light	4-14
Low tire pressure warning light	4-14
Forward safety warning light	4-15
Lane safety indicator light.....	4-15
All Wheel Drive (AWD) warning light	4-15
LED headlight warning light.....	4-16
Icy road warning light.....	4-16
Electronic Stability Control (ESC) indicator light.....	4-17
Electronic Stability Control (ESC) OFF indicator light.....	4-17
Immobilizer indicator light.....	4-17
Turn signal indicator light.....	4-18
High beam indicator light	4-18
Light ON indicator light.....	4-18
High Beam Assist indicator light.....	4-19
AUTO HOLD indicator light	4-19

LCD Display Messages.....	4-19
Shift to P	4-19
Low key battery.....	4-19
Press START button while turning wheel	4-19
Press brake pedal to start vehicle.....	4-19
Key not in vehicle.....	4-20
Key not detected.....	4-20
Press START button again	4-20
Press START button with key.....	4-20
Check BRAKE SWITCH fuse	4-20
Shift to P to start vehicle	4-20
Check smart key system.....	4-20
Door, Hood, Liftgate open indicator.....	4-21
Low tire pressure	4-21
Lights	4-21
Wiper	4-22
Low washer fluid	4-22
Check headlight.....	4-22
Check turn signal	4-22
Check headlight LED	4-22
Shift to P to charge/Shift to P to start charging	4-23
Remaining time.....	4-23
Unplug vehicle to start	4-23
Charging door open.....	4-23
Charging stopped. Check the AC/DC charger.....	4-24
Charging stopped. Check the cable connection.....	4-24
Check regenerative brakes.....	4-25
Low EV battery.....	4-25
Charge immediately. Power limited	4-25
12V battery discharging due to additional electrical devices	4-26
Power limited due to low EV battery temperature. Charge battery.....	4-26
EV battery overheated! Stop vehicle	4-27
Power limited	4-27
Stop vehicle and check power supply.....	4-28
Check active air flap system	4-28
Check virtual engine sound system.....	4-28
Check electric vehicle system	4-28

4. Instrument Cluster

LCD Display	4-29
LCD Display Control	4-29
View Modes	4-29
Driving Assist view	4-30
Turn By Turn (TBT) view	4-30
Utility view	4-31
Additional information display	4-33
Vehicle Settings (Infotainment System)	4-34
Setting Your Vehicle	4-34

INSTRUMENT CLUSTER

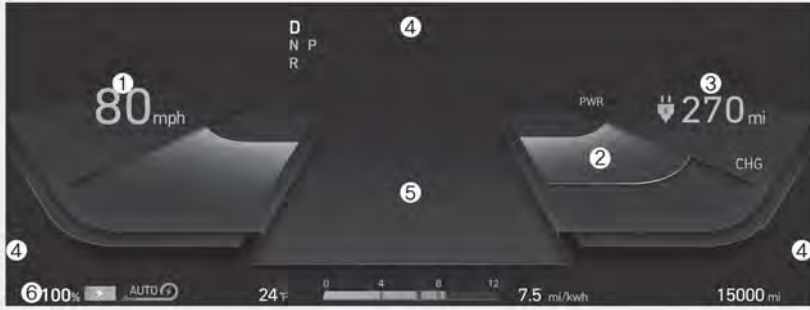

The actual cluster in the vehicle may differ from the illustration.
For more information, refer to “Gauges and meters” section in this chapter.

ONE1041021N

1. Speedometer
2. Power/Charge gauge
3. Distance to empty
4. Warning indicator light
5. LCD display
6. Battery SOC (State of Charge) gauge

i Information

- **SNOW/NORMAL/ECO/SPORT mode by pressing the drive mode button will change the main theme of the cluster**

Instrument Cluster Control

Instrument panel illumination

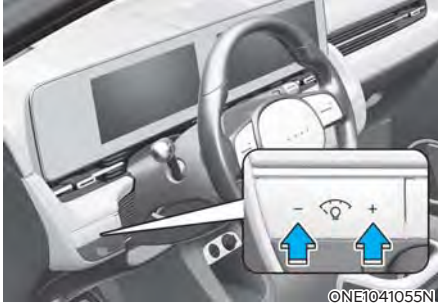

When the vehicle's position lights or headlights are on, press the illumination control switch to adjust the brightness of the instrument panel illumination.

When pressing the illumination control switch, the interior switch illumination intensity is also adjusted.



WARNING

Never adjust the instrument cluster while driving. This could result in loss of control and lead to an accident that may cause death, serious injury, or vehicle damage.

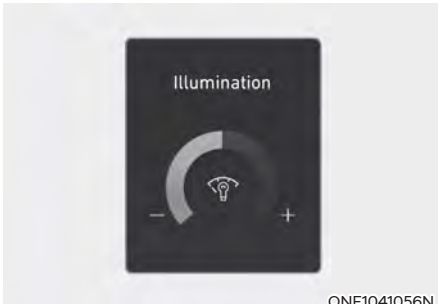

- The brightness of the instrument panel illumination is displayed.
- If the brightness reaches the maximum or minimum level, a chime will sound.

Gauges and Meters

Speedometer



The speedometer indicates the speed of the vehicle and is calibrated in miles per hour (MPH).

Power/Charge Gauge

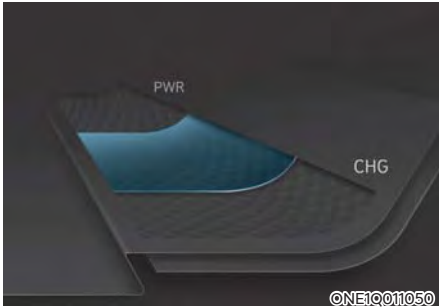

The Power/Charge Gauge shows the energy consumption rate of the vehicle and the charge/discharge status of the regenerative brakes.

- **POWER :**
It shows the energy consumption rate of the vehicle when driving uphill or accelerating. The more electric energy is used, the higher the gauge level.
- **CHARGE :**
It shows the charging status of the battery when it is being charged by the regenerative brakes (decelerating or driving on a downhill road). The more electric energy is charged, the lower the gauge level.

State of Charge (SOC) Gauge for High Voltage Battery

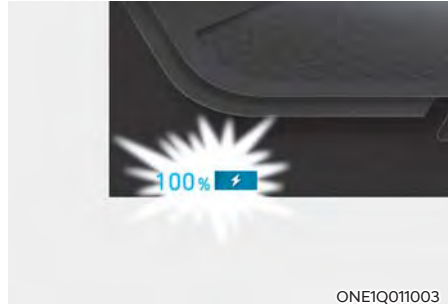

- The SOC gauge shows the charging status of the high voltage battery.
- The low percentage number on the indicator indicates that there is not enough energy in the high voltage battery. 100% indicates that the driving battery is fully charged.
- When driving on highways or motorways, make sure to check in advance if the driving battery is charged enough.

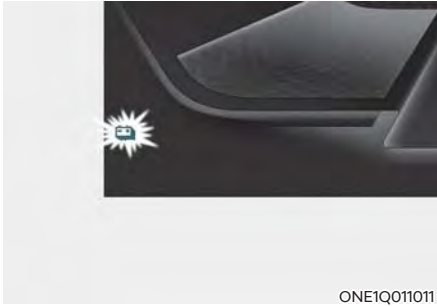

ONE1Q011011

When the remaining battery is lower than 10 % on the SOC gauge, the warning light (🔋⚡) turns ON to alert you of the battery level.

When the warning light (🔋⚡) turns ON, the vehicle can drive an additional 18 ~ 25 miles (30 ~ 40 km) depending on the driving speed, heater/air conditioner, weather, driving style, and other factors. Charging is required.

NOTICE

The output is limited as the remaining battery is low.

When the Power Down Indicator Light is on, the vehicle may be limited to a certain speed, it may be difficult to climb hills, or the vehicle may be pushed back, so charge it immediately.

Outside temperature gauge

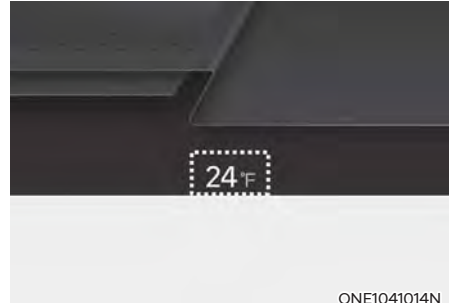

ONE1041014N

This gauge indicates the current outside air temperatures by 1°F (1°C).

Note that the temperature indicated on the LCD display may not change as quickly as the outside temperature (there may be a slight delay before the temperature changes.)

You can change the temperature unit from the Settings menu in the infotainment system screen. Select:

- General Settings → Unit → Temperature Unit → °C/°F

For detailed information, refer to the separately supplied infotainment system manual.

Both the temperature unit on the cluster LCD display and climate control screen will change.

Odometer



The odometer indicates the total distance that the vehicle has been driven and should be used to determine when periodic maintenance should be performed.

Distance to empty



- The distance to empty is the estimated distance the vehicle can be driven with the remaining electric energy.
- The distance to empty varies depend on which drive mode is selected among ECO/NORMAL/SPORT mode.

For more detail information, refer to 'Distance to empty' in chapter 1.

i Information

- **If the vehicle is not on level ground or the battery power has been interrupted, the distance to empty function may not operate correctly.**
- **The distance to empty may differ from the actual driving distance as it is an estimate of the available driving distance.**
- **The distance to empty may vary significantly based on driving conditions, driving habits, and condition of the vehicle.**

Reduction Gear Shift Indicator



The indicator displays which gear is selected.

Regenerative braking level indicator



The regenerative brake indicates the level of the regenerative braking that you set. And it also indicates Smart regenerative system's operation status.

For more details, refer to "Regenerative Braking System" in chapter 6.

Warning and Indicator Lights

i Information

Make sure that all warning lights are OFF after starting the vehicle. If any light is still ON, this indicates a situation that needs attention.

Ready indicator

READY

This indicator illuminates:

When the vehicle is ready to be driven.

- ON : Normal driving is possible.
- OFF : Normal driving is not possible, or a problem has occurred.
- Blinking : Emergency driving.

When the ready indicator goes OFF or blinks, there is a problem with the system. In this case, have your vehicle inspected by an authorized HYUNDAI dealer.

Service warning light



This warning light illuminates:

- When the START/STOP button is in the ON position.
 - It illuminates for approximately 3 seconds and then goes off.
- When there is a problem with related parts of the electric vehicle control system, such as sensors, etc.

When the warning light illuminates while driving, or does not go OFF after starting the vehicle, have your vehicle inspected by an authorized HYUNDAI dealer.

Power down indicator light



This indicator light illuminates:

- When the START/STOP button is in the ON position.
 - It illuminates for approximately 3 seconds and then goes off.
- When the power is limited for the safety of the high-powered parts of an electric vehicle. The power is limited for the following reasons. (Unless both Service Warning Light and Power Down Indicator Light illuminate at the same time, it is not a failure.)
 - The high voltage battery level is too low or voltage is decreasing
 - The temperature of the high voltage battery is too high or too low
 - The temperature of the motor is high

NOTICE

- **Do not accelerate or start the vehicle suddenly when the power down indicator light is ON.**
- **When the power is limited for the safety of the high-powered parts of an electric vehicle, the power down indicator light illuminates. Your vehicle may not be driven, or may roll back on a slope with the indicator light ON due to the limitation of vehicle power.**

Charging connector indicator light



This warning light indicates the connection status of the charging connector. When the charging connector is connected to the vehicle, the green light illuminates for approximately 1 minute.

High voltage battery level warning light



This warning light illuminates:

- When the high voltage battery level is low.
- When the warning light turns ON, charge the battery immediately.

Seat belt warning light



This warning light informs the driver that the seat belt is not fastened.

For more details, refer to “Seat Belts” section in chapter 3.

Air bag warning light



This warning light illuminates:

- When you set the Start/Stop button to the ON position.
 - The air bag warning light illuminates for about 6 seconds and then turns off when all checks have been performed.
- The air bag warning light will remain illuminated if there is a malfunction with the Safety Restraint System (SRS) air bag operation.

If this occurs, have the vehicle inspected by an authorized HYUNDAI dealer.

Regenerative brake warning light



This warning light illuminates:

When the regenerative brake does not operate and the brake does not perform well. This causes the Brake Warning light (red) and Regenerative Brake Warning Light (yellow) to illuminate simultaneously.

In this case, drive safely and have your vehicle inspected by an authorized HYUNDAI dealer.

The operation of the brake pedal may be more difficult than normal and the braking distance can increase.

Parking brake & brake fluid warning light



This warning light illuminates:

- When you set the START/STOP button in the ON position.
 - It illuminates for approximately 3 seconds.
 - It remains on if the parking brake is applied.
- When the parking brake is applied.
- When the brake fluid level in the reservoir is low.
 - If the warning light illuminates with the parking brake released, it indicates the brake fluid level in the reservoir is low.
- When the regenerative brake does not operate.

If the brake fluid level in the reservoir is low:

1. Drive carefully to the nearest safe location and stop your vehicle.
2. With the motor stopped, check the brake fluid level immediately and add fluid as required (**For more details, refer to “Brake Fluid” section in chapter 9**). After adding brake fluid, check all brake components for fluid leaks. If a brake fluid leak is found, or if the warning light remains on, or if the brakes do not operate properly, do not drive the vehicle. Have the vehicle inspected by an authorized HYUNDAI dealer.

Dual-diagonal braking system

Your vehicle is equipped with dual-diagonal braking system. This means you still have braking on two wheels even if one of the dual systems should fail.

With only one of the dual systems working, more than normal pedal travel and greater pedal pressure is required to stop the vehicle.

Also, the vehicle will not stop in as short a distance with only a portion of the brake system working.

If the brakes fail while you are driving, shift to a lower gear for additional vehicle braking and stop the vehicle as soon as it is safe to do so.



WARNING

Parking Brake & Brake Fluid warning light

Driving the vehicle with a warning light ON is dangerous. If the Parking Brake & Brake Fluid warning light illuminates with the parking brake released, it indicates that the brake fluid level is low.

If this occurs, have the vehicle inspected by an authorized HYUNDAI dealer.

Anti-lock Brake System (ABS) warning light



This warning light illuminates:

- When you set the Start/Stop button to the ON position.
 - The ABS warning light illuminates for about 3 seconds and then goes off.
- Whenever there is a malfunction with the ABS.

Note that the hydraulic braking system will still be operational even if there is a malfunction with the ABS.

If this occurs, have the vehicle inspected by an authorized HYUNDAI dealer.

Electronic Brake Force Distribution (EBD) system warning light



When the ABS warning and Parking Brake warning lights are on simultaneously, it may indicate a problem with the Electronic Brake Force Distribution system.

If this occurs, have the vehicle inspected by an authorized HYUNDAI dealer.

**WARNING**

Electronic Brake Force Distribution (EBD) system warning light

When both ABS and Parking Brake & Brake Fluid warning lights are on, the brake system will not work normally and you may experience an unexpected and dangerous situation during sudden braking.

If this occurs, avoid high speed driving and abrupt braking.

Have the vehicle inspected by an authorized HYUNDAI dealer as soon as possible.

NOTICE

Electronic Brake Force Distribution (EBD) system warning light

When the ABS warning light is on or both ABS and Parking Brake & Brake Fluid warning lights are on, the speedometer, odometer, or tripmeter may not work. Also, the MDPS warning light may illuminate and the steering effort may increase or decrease.

If this occurs, have the vehicle inspected by an authorized HYUNDAI dealer as soon as possible.

Motor Driven Power Steering (MDPS) warning light

This warning light illuminates:

- When you set the Start/Stop button to the ON position.
 - The motor driven power steering warning light illuminates for about 3 seconds and then goes off.
- Whenever there is a malfunction with the electric power steering.
 - If this occurs, have the vehicle inspected by an authorized HYUNDAI dealer.

Master warning light

This warning light illuminates:

When there is a malfunction in operation in any of the following systems:

- Forward Collision-Avoidance Assist malfunction (if equipped)
- Forward Collision-Avoidance Assist radar blocked (if equipped)
- Blind-Spot Collision Warning malfunction (if equipped)
- Blind-Spot Collision Warning radar blocked (if equipped)
- LED headlight malfunction (if equipped)
- High Beam Assist malfunction (if equipped)
- Smart Cruise Control malfunction (if equipped)
- Smart Cruise Control radar blocked (if equipped)
- Tire Pressure Monitoring System (TPMS) malfunction

To identify the details of the warning, look at the LCD display.

Electronic Parking Brake (EPB) warning light

EPB

This warning light illuminates:

- When you set the Start/Stop button to the ON position.
 - The EPB warning light illuminates for about 3 seconds and then goes off.
- Whenever there is a malfunction with EPB.

If this occurs, have the vehicle inspected by an authorized HYUNDAI dealer.

Information

The Electronic Parking Brake (EPB) warning light may illuminate when the Electronic Stability Control (ESC) indicator light comes on to indicate that ESC is not working properly. This does not indicate malfunction of EPB.

Low tire pressure warning light



This warning light illuminates:

- When you set the Start/Stop button to the ON position.
 - The low tire pressure warning light illuminates for approximately 3 seconds and then goes off.
- When one or more of your tires are significantly underinflated. (The location of the underinflated tires are displayed on the LCD display.)

For more details, refer to “Tire Pressure Monitoring System (TPMS)” section in chapter 8.

This warning light remains ON after blinking for approximately 60 seconds, or repeatedly blinks ON and OFF in 3 second intervals:

When there is a malfunction with the TPMS.

If this occurs, have the vehicle inspected by an authorized HYUNDAI dealer as soon as possible.

For more details, refer to “Tire Pressure Monitoring System (TPMS)” section in chapter 8.

**WARNING****Safe Stopping**

- The TPMS cannot alert you to severe and sudden tire damage caused by external factors.
- If you notice any vehicle instability, immediately take your foot off the accelerator pedal, apply the brakes gradually with light force, and slowly move to a safe position off the road.

Forward safety warning light (if equipped)**This warning light illuminates:**

- When you set the Start/Stop button to the ON position.
 - The Forward Safety warning light illuminates for approximately 3 seconds and then goes off.
- Whenever there is a malfunction with Forward Collision-Avoidance Assist.

If this occurs, have the vehicle inspected by an authorized HYUNDAI dealer.

For more details, refer to “Forward Collision-Avoidance Assist (FCA)” section in chapter 7.

Lane safety indicator light (if equipped)**This indicator light illuminates:**

- [Green] When Lane Keeping Assist operating conditions are satisfied.
- [White] When Lane Keeping Assist operating conditions are not satisfied.
- [Yellow] Whenever there is a malfunction with Lane Keeping Assist. If this occurs, have the vehicle inspected by an authorized HYUNDAI dealer.

For more details, refer to “Lane Keeping Assist (LKA)” section in chapter 7.

All Wheel Drive (AWD) warning light (if equipped)**This warning light illuminates:**

Whenever there is a malfunction with the AWD system.

If this occurs frequently, have the vehicle inspected by an authorized HYUNDAI dealer.

For more details, refer to “All Wheel Drive (AWD)” section in chapter 6.

**LED headlight warning light
(if equipped)**



This warning light illuminates:

- When you set the Start/Stop button to the ON position.
 - The LED headlight warning light illuminates for approximately 3 seconds and then goes off.
- Whenever there is a malfunction with the LED headlight.

If this occurs, have the vehicle inspected by an authorized HYUNDAI dealer.

This warning light blinks:

Whenever there is a malfunction with a LED headlight related part.

If this occurs, have the vehicle inspected by an authorized HYUNDAI dealer.

NOTICE

Continuous driving with the LED Headlight warning light on or blinking can reduce LED headlight life.

**Icy road warning light
(if equipped)**



This warning light is to warn the driver the road may be icy.

When the temperature on the outside temperature gauge is approximately below 4°C (40°F), the Icy Road warning light and Outside Temperature Gauge blinks and then illuminates. Also, the warning chime sounds 1 time.

You can activate or deactivate Icy Road Warning function from the Settings menu in the infotainment system screen. Select:

- Setup → Vehicle Settings → Cluster → Content Selection → Icy Road Warning

For detailed information, refer to the separately supplied infotainment system manual.

***i* Information**

If the Icy Road warning light appears while driving, you should drive more attentively and safely refraining from over-speeding, rapid acceleration, sudden braking or sharp turning, etc.

Electronic Stability Control (ESC) indicator light



This indicator light illuminates:

- When you set the Start/Stop button to the ON position.
 - The Electronic Stability Control indicator light illuminates for about 3 seconds and then goes off.
- Whenever there is a malfunction with ESC system.

If this occurs, have the vehicle inspected by an authorized HYUNDAI dealer.

This indicator light blinks:

While ESC is operating.

For more details, refer to “Electronic Stability Control (ESC)” section in chapter 6.

Electronic Stability Control (ESC) OFF indicator light



This indicator light illuminates:

- When you set the Start/Stop button to the ON position.
 - The ESC OFF indicator light illuminates for approximately 3 seconds and then goes off.
- When you deactivate ESC system by pressing the ESC OFF button.

For more details, refer to “Electronic Stability Control (ESC)” section in chapter 6.

Immobilizer indicator light



This indicator light illuminates for up to 30 seconds:

When the vehicle detects the smart key in the vehicle with the Start/Stop button in the ACC or ON position.

- Once the smart key is detected, you can start the vehicle.
- The indicator light goes off after starting the vehicle.

This indicator light blinks for a few seconds:

When the smart key is not in the vehicle.

- If the smart key is not detected, you cannot start the vehicle.

This indicator light illuminates for 2 seconds and goes off:

If the smart key is in the vehicle and the Start/Stop button is ON, but the vehicle cannot detect the smart key.

If this occurs, have the vehicle inspected by an authorized HYUNDAI dealer.

This indicator light blinks:

Whenever there is a malfunction with the immobilizer system.

If this occurs, have the vehicle inspected by an authorized HYUNDAI dealer.

Turn signal indicator light



This indicator light blinks:

When you operate the turn signal indicator stalk.

If any of the following occur, there may be a malfunction with the turn signal system.

- The turn signal indicator light illuminates but does not blink
- The turn signal indicator light blinks rapidly
- The turn signal indicator light does not illuminate at all

If any of these conditions occur, have the vehicle inspected by an authorized HYUNDAI dealer.

High beam indicator light



This indicator light illuminates:

- When the headlights are on and in the high beam position
- When the turn signal lever is pulled into the Flash-to-Pass position.

Light ON indicator light



This indicator light illuminates:

When the Parking lamps or headlights are on.

High Beam Assist indicator light (if equipped)



This indicator light illuminates:

When the high-beam is on with the light switch in the AUTO position.

- White : When High Beam Assist is ready to operate.
- Green : When High Beam Assist is operating.

If your vehicle detects oncoming or preceding vehicles, High Beam Assist will switch the high beam to low beam automatically.

For more details, refer to “High Beam Assist (HBA)” section in chapter 5.

AUTO HOLD indicator light



This indicator light illuminates:

- [White] When you activate Auto Hold by pressing the AUTO HOLD switch.
- [Green] When you stop the vehicle completely by depressing the brake pedal with Auto Hold activated.
- [Yellow] Whenever there is a malfunction with the Auto Hold function.

If this occurs, have the vehicle inspected by an authorized HYUNDAI dealer.

For more details, refer to “Electronic Parking Brake (EPB)” section in chapter 6.

LCD Display Messages

Shift to P

This message is displayed if you try to turn off the vehicle without the gear in the P (Park) position.

If this occurs, the Start/Stop button turns to the ACC position.

Low key battery

This message is displayed if the battery of the smart key is discharged while changing the Start/Stop button to the OFF position.

Press START button while turning wheel (if equipped)

This message is displayed if the steering wheel does not unlock normally when the Start/Stop button is pressed.

You should press the Start/Stop button while turning the steering wheel right and left.

Press brake pedal to start vehicle

This message is displayed if the Start/Stop button changes to the ACC position twice by pressing the button repeatedly without depressing the brake pedal.

You can start the vehicle by depressing the brake pedal and then pressing the Start/Stop button.

Key not in vehicle

This message is displayed if the smart key is not in the vehicle when you leave the vehicle with the Start/Stop button in the ON or Start position.

Always turn off the vehicle before leaving your vehicle.

Key not detected

This message is displayed if the smart key is not detected when you press the Start/Stop button.

Press START button again

This message is displayed if you were unable to start the vehicle when the Start/Stop button was pressed.

If this occurs, attempt to start the vehicle by pressing the Start/ Stop button again.

If the warning message appears each time you press the Start/Stop button, have the vehicle inspected by an authorized HYUNDAI dealer.

Press START button with key

This message is displayed if you press the Start/Stop button while the warning message “Key not detected” is displayed.

At this time, the immobilizer indicator light blinks.

Check BRAKE SWITCH fuse

This message is displayed if the brake switch fuse is disconnected.

You need to replace the fuse with a new one before starting the vehicle.

If that is not possible, you can start the vehicle by pressing the Start/Stop button for 10 seconds in the ACC position.

Shift to P to start vehicle

This message is displayed if you try to start the vehicle in any other position except P (Park).

Information

For your safety, we recommend that you start the engine with the gear shifted to P (Park).

Check smart key system

This message is displayed when there is a problem with the smart key system. Have the vehicle inspected by an authorized HYUNDAI dealer.

Door, Hood, Liftgate open indicator



This warning is displayed if any door or hood or liftgate is left open. The warning will indicate which door is open in the display.



CAUTION

Before driving the vehicle, you should confirm that the door/ hood/liftgate are fully closed.

Low tire pressure



This warning message is displayed if the tire pressure is low. The corresponding tire on the vehicle will be illuminated.

For more details, refer to “Tire Pressure Monitoring System (TPMS)” section in chapter 8.

Lights



This indicator displays which exterior light is selected using the lighting control.

You can activate or deactivate Wiper/Lights display function from the Settings/Lights display menu in the infotainment system screen. Select:

- Setup → Vehicle Settings → Cluster
→ Content Selection → Wiper/Lights Display

For detailed information, refer to the separately supplied infotainment system manual.

Wiper



This indicator displays which wiper speed is selected using the wiper control.

You can activate or deactivate Wiper/Lights display function from the Settings menu in the infotainment system screen. Select:

- Setup → Vehicle Settings → Cluster → Content Selection → Wiper/Lights Display

For detailed information, refer to the separately supplied infotainment system manual.

Low washer fluid (if equipped)

This message is displayed if the washer fluid level in the reservoir is nearly empty. Have the washer fluid reservoir refilled.

Check headlight (if equipped)

This message is displayed if the headlights are not operating properly. A lamp may need to be replaced.

Make sure to replace the burned out bulb with a new one of the same wattage rating.

Check turn signal (if equipped)

This message is displayed if the turn signal lamps are not operating properly. A lamp may need to be replaced.

Make sure to replace the burned out bulb with a new one of the same wattage rating.

Check headlight LED (if equipped)

This message is displayed if there is a problem with the LED headlight. Have the vehicle inspected by an authorized HYUNDAI dealer.

Shift to P to charge/Shift to P to start charging



This message is displayed if you connect the charging cable without the gear in the P (Park) position.

Shift to P (Park) before connecting the charging cable.

Remaining time

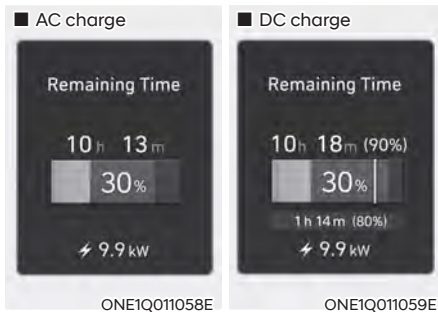

This message is displayed to notify the remaining time to charge the battery to the selected target battery charge level.

Unplug vehicle to start



This message is displayed when you start the vehicle without unplugging the charging cable. Unplug the charging cable, and then turn on the vehicle.

Charging door open



This message is displayed when the vehicle is driven with the charging door opened. Close the charging door and then start driving.

Charging stopped. Check the AC/DC charger

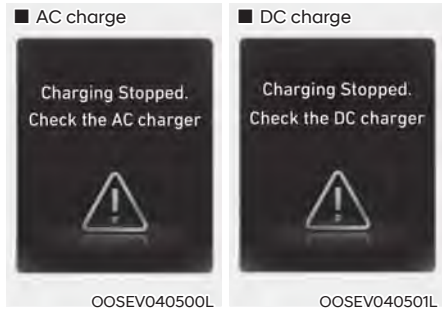

- This warning message is displayed when charging is stopped for the reasons below:
 - There is a problem with the external AC charger or DC charger
 - The external AC charger stopped charging
 - The charging cable is damaged

In this case, check whether there is any problem with the external AC or DC charger and charging cable.

If the same problem occurs when charging the vehicle with a normally operating AC charger or genuine HYUNDAI portable charger, have your vehicle inspected by an authorized HYUNDAI dealer.

Charging stopped. Check the cable connection



This warning message is displayed when charging is stopped because the charging connector is not correctly connected to the charging inlet

In this case, separate the charging connector and re-connect it and check whether there is any problem (external damage, foreign substances, etc.) with the charging connector and charging inlet.

If the same problem occurs when charging the vehicle with a replaced charging cable or genuine HYUNDAI portable charger, have your vehicle inspected by an authorized HYUNDAI dealer.

Check regenerative brakes



These warning messages are displayed when the regenerative brake system does not work properly.

In this case, have the vehicle inspected by an authorized HYUNDAI dealer.

Low EV battery



When the high voltage battery level reaches below approximately 10 %, this warning message is displayed.

The warning light on the instrument cluster (⚡) will turn ON simultaneously.

Charge the high voltage battery immediately.

Charge immediately. Power limited



When the high voltage battery level reaches below approximately 5 %, this warning message is displayed.

The warning light on the instrument cluster (⚡) will turn on simultaneously.

The vehicle's power will be reduced to minimize the energy consumption of the high voltage battery. Charge the battery immediately.

12V battery discharging due to additional electrical devices



This warning message is displayed when a battery discharge due to excessive current is detected by mounting an unauthorized electrical device such as a black box.

Be careful as it may cause battery discharge problems.

If the warning message is not disappeared after the external electrical device is removed, have the vehicle inspected by an authorized HYUNDAI dealer.

Power limited due to low EV battery temperature. Charge battery



Both warning messages are displayed to protect electric vehicle system when outside temperature is low. If the high voltage battery charging level is low and parked outside in low temperature for a long time, vehicle power could be limited.

Charging the battery before driving helps increase power.

NOTICE

If these warning messages are still displayed even after the ambient temperature has increased, have the vehicle inspected by an authorized HYUNDAI dealer.

EV battery overheated! Stop vehicle

This warning message is displayed to protect battery and electric vehicle system when the high voltage battery temperature is too high.

Turn off the START/STOP button and stop the vehicle so that the battery temperature decreases.

Power limited

This Indicator light illuminates:

- When the START/STOP button is in the ON position.
 - It illuminates for approximately 3 seconds and then goes off.
- When the power is limited for the safety of the high-powered parts of an electric vehicle. The power is limited for the following reasons. (Unless both Service Warning Light and Power Down Indicator Light illuminate at the same time, it is not a failure.)
 - The high voltage battery level is too low or voltage is decreasing
 - The temperature of the high voltage battery is too high or too low
 - The temperature of the motor is high

NOTICE

- **When this warning message is displayed, do not accelerate or start the vehicle suddenly.**
- **When the power is limited for the safety of the high-powered parts of an electric vehicle, the warning message is displayed. Your vehicle may not be driven, or may roll back on a slope with the warning message displayed due to the limitation of vehicle power.**

Stop vehicle and check power supply



This warning message is displayed when a failure occurs in the power supply system.

In this case, park the vehicle in a safe location and tow your vehicle to the nearest authorized HYUNDAI dealer and have the vehicle inspected.

Check active air flap system



This warning message is displayed in the following situations:

- There is a malfunction with the actuator flap
- There is a malfunction with the actuator air flap controller
- The air flap does not open

When all of the above conditions are fixed, the warning will disappear.

Check virtual engine sound system



This message is displayed when there is a problem with the Virtual Engine Sound System (VESS).

In this case, have the vehicle inspected by an authorized HYUNDAI dealer.

Check electric vehicle system



This warning message is displayed when there is a problem with the electric vehicle control system.

Refrain from driving when the warning message is displayed.

In this case, have the vehicle inspected by an authorized HYUNDAI dealer.

LCD DISPLAY

LCD Display Control



ONE1041018

The LCD display modes can be changed by using the control switches.

Switch	Operation	Function
	Press	MODE button for changing View modes
	Press	UP, DOWN switch for changing items in Utility view and Option menu
OK	Press	SELECT/RESET switch for entering Option menu
	Press and hold	SELECT/RESET switch for retrieving assist information or resetting the selected item

View Modes

View modes	Explanation
Driving Assist	Driving Assist view displays the status of the vehicle's Driver Assistance systems.
Turn by Turn	Turn By Turn view displays the state of the navigation.
Utility	Utility view displays driving information such as the trip distance, electric energy economy and etc.

The information provided may differ depending on which features are applicable to your vehicle.



Driving Assist, Turn by Turn, Utility view modes are displayed in the center (A) of the instrument cluster.

Driving Assist view

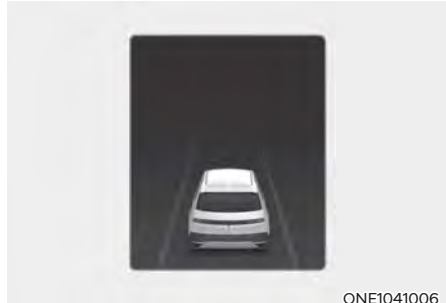

The status of Manual Speed Limit Assist, Smart Cruise Control, Lane Following Assist, Highway Driving Assist, etc., is displayed when Driving Assist view is selected.

For more details, refer to each function information section in chapter 7.

Turn By Turn (TBT) view



Turn-by-turn navigation, distance/time to destination information is displayed when Turn by Turn view is selected.

Utility view

In the Utility view, using the \wedge , \vee (UP, DOWN) switch, you may change through items in the following order.



Drive info

Trip distance, average electric energy economy and total driving time are displayed.

The driver's door is opened after turning off the vehicle or the vehicle is turned on after 3 minutes have passed, the Drive Info screen will reset.



After Recharging

Trip distance, total driving time and average energy consumption after the vehicle has been recharged are displayed. To reset manually, press the OK button on the steering wheel for more than 1 second when 'After recharging' is displayed.

Accumulated info



This display shows the accumulated trip distance (1), the average energy consumption (2), and the total driving time (3).

The information is accumulated starting from the last reset.

To manually reset the information, press and hold the OK button when viewing the Accumulated driving info. The trip distance, the average energy consumption, and total driving time will reset simultaneously.

The accumulated driving information will continue to be counted while the vehicle is in the ready (READY) mode (for example, when the vehicle is in traffic or stopped at a stop light).

i Information

The vehicle must be driven for a minimum of 0.19 miles (300 meters) since the last ignition key cycle before the accumulated driving information is recalculated.



ONE1041059L

Attention level

The driver's attention level is shown based on the driver's driving pattern.

For more details, refer to "Driver Attention Warning (DAW)" section in chapter 7.



ONE1041010L

Tire pressure

The tire pressure of each tire is displayed.

For more details, refer to "Tire Pressure Monitoring System (TPMS)" section in chapter 8.

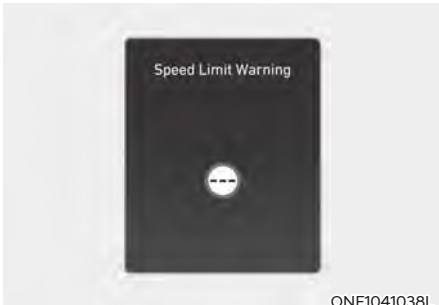

ONE1041038L

Speed limit warning (if equipped)

The driver can monitor the information provided from Intelligent Speed Limit Assist.

For more details, refer to "Intelligent Speed Limit Assist (ISLA)" section in chapter 7.



ONE1041011

Energy flow / Driving force distribution (if equipped)

- The electric vehicle system informs the drivers its energy flow in various operating modes.
- The distribution status of the driving power of the front and rear wheels are displayed when Auto AWD mode is activated.

For more details, refer to "Four Wheel Drive (AWD)" section in chapter 6.

Additional information display

■ Type A



ONE1041047N

Drive info

Drive information is displayed for 4 seconds after the vehicle is turned off.



ONE1041031N

Driving assist information

The current operation conditions of Manual Speed Limit Assist, Cruise Control, Smart Cruise Control, Lane Following Assist, Highway Driving Assist, etc., is displayed.

VEHICLE SETTINGS (INFOTAINMENT SYSTEM)

Vehicle Settings in the infotainment system provides user options for a variety of settings including door lock/unlock features, convenience features, driver assistance settings, etc.

Vehicle Settings menu

- Driver Assistance
- Drive Mode
- EV
- Head-Up Display
- Cluster
- Climate
- Seat
- Lights
- Door
- Convenience

The information provided may differ depending on which features are applicable to your vehicle.

WARNING

Do not operate the Vehicle Settings while driving. This may cause distraction resulting in an accident.

Setting Your Vehicle

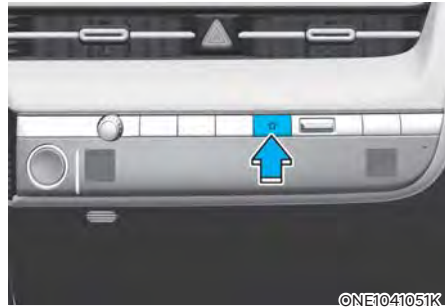

1. Press the Custom (★) button on the main keyboard.
2. Select 'Vehicle' to change the Vehicle Settings.

For detailed information, refer to the separately supplied infotainment system manual.

5. Convenience Features

Accessing Your Vehicle.....	5-4
Smart Key.....	5-4
Immobilizer System	5-14
Hyundai Digital Key.....	5-15
Door Locks.....	5-30
Operating Door Unlocks from Outside the Vehicle (Manual type).....	5-30
Operating Door Unlocks from Outside the Vehicle (Electric type).....	5-30
Operating Door Locks from Outside the Vehicle (Manual type).....	5-32
Operating Door Locks from Outside the Vehicle (Electric type).....	5-32
Operating Door Lock/Unlock from Inside the Vehicle.....	5-34
Automatic Door Lock and Unlock Features.....	5-36
Electronic Child Safety Lock.....	5-37
Vehicle Auto-Shut Off Function	5-38
Theft-Alarm System	5-39
Advanced Rear Occupant Alert (ROA).....	5-40
System Setting.....	5-40
System Operation.....	5-40
Integrated Memory System.....	5-41
Storing Memory Positions	5-41
Recalling Memory Positions	5-41
Resetting the System.....	5-42
Seat Easy Access.....	5-43
Memory Seat Configurations	5-44
Storing Memory Positions	5-44
Recalling Memory Positions	5-44
Steering Wheel.....	5-45
Motor Driven Power Steering (MDPS)	5-45
Tilt/Telescopic Steering	5-46
Horn.....	5-47
Heated Steering Wheel.....	5-47
Mirrors	5-49
Inside Rearview Mirror.....	5-49
Side View Mirrors	5-60
Reverse Parking Aid	5-62
Digital Center Mirror (DCM).....	5-64
System Component	5-66
How To Change the Mode	5-67
Display Settings (Digital Mirror Mode).....	5-68

Windows	5-72
Power Windows.....	5-73
Vision Roof	5-76
Resetting the Vision Roof	5-78
Exterior Features.....	5-79
Hood.....	5-79
Front trunk	5-80
Power Liftgate	5-81
Smart Liftgate.....	5-87
Electric Charging Door	5-90
Augmented Reality HUD	5-91
Head-up Display Settings.....	5-91
Head-up Display Information.....	5-92
Precautions while Using the Head-up Display.....	5-93
Lighting.....	5-94
Exterior Lights	5-94
Interior Lights	5-98
High Beam Assist (HBA)	5-102
High Beam Assist Settings.....	5-102
High Beam Assist Operation.....	5-103
High Beam Assist Malfunction and Limitations	5-104
Wipers and Washers	5-105
Front Windshield Wipers	5-105
Front Windshield Washers.....	5-107
Automatic Climate Control System	5-108
Climate.....	5-109
Automatic Temperature Control Mode.....	5-109
Manual Temperature Control Mode.....	5-111
System Operation.....	5-119
System Maintenance	5-120
Windshield Defrosting And Defogging.....	5-122
To Defog Inside Windshield.....	5-122
To Defrost Outside Windshield.....	5-123
Defogging Logic.....	5-123
Rear Window Defroster.....	5-124

5. Convenience Features

Climate Control Additional Features	5-125
A/C Automatic Drying	5-125
Auto Defogging System	5-126
Auto Dehumidify	5-127
Recirculating Air When Washer Fluid Is Used	5-127
Auto. Controls That Use Climate Control Settings (for driver's seat)	5-128
Smart Ventilation	5-128
Storage Compartment.....	5-129
Center Console Storage.....	5-129
Glove Box.....	5-130
Interior Features.....	5-131
Cup Holder.....	5-131
Sunvisor	5-132
Power Outlet.....	5-132
USB Charger	5-133
Wireless Smart Phone Charging System	5-134
Cluster Fascia Side Panel.....	5-137
Vehicle to Load (V2L)	5-137
Clock	5-137
Coat Hook.....	5-138
Floor Mat Anchor(s).....	5-138
Rear Side Window Sunshades.....	5-139
Luggage Net Holder.....	5-139
Cargo Security Screen	5-140
Infotainment System	5-142
USB Port.....	5-142
Antenna.....	5-142
Steering Wheel Remote Controls.....	5-142
Infotainment System.....	5-143
Voice Recognition	5-144
Bluetooth® Wireless Technology.....	5-144

ACCESSING YOUR VEHICLE

Smart Key

■ Type A



ONE1051259N

■ Type B



ONE1052034N

■ Type C



ONE1051260N

■ Type D



ONE1052035N

Your electric vehicle uses a Smart Key, which you can use to lock or unlock the driver and passenger doors, the charging door or the rear liftgate.

1. Door lock
2. Door unlock
3. Liftgate open/close
4. Panic
5. Remote Start
6. Charging door open/close
7. Forward / Backward (if equipped)

Locking your vehicle

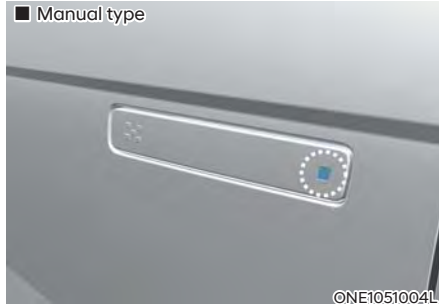

To lock your vehicle using the door handle button or the Smart Key:

1. Make sure all doors, the hood and the liftgate are closed.
2. Press the Door Lock button (1) on the Smart Key. The hazard warning lights will blink with an alarm, and the doors will be locked.
3. In addition, pushing the button on the door handle (the engraved part) while keeping the smart key will lock all doors.

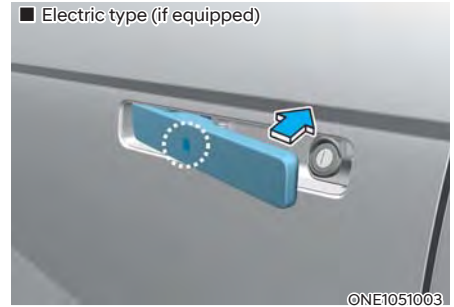

To lock your vehicle using the door handle touch sensor or the Smart Key:

1. Make sure all doors, the hood and the liftgate are closed.
 2. Press the Door Lock button (1) on the Smart key. The hazard warning lights will blink with an alarm, and the handles will retract back.
- In addition, touching the touch sensor on the door handle (the engraved part) while keeping the smart key will lock all doors and let the door handle to retract back.

Information

- The side view mirror will fold if 'Enable on Door Unlock' is selected from the Settings menu in the infotainment system screen. Select:
 - Setup → Vehicle Settings → Convenience → Welcome Mirror → Enable on Door Unlock
- The door handle touch sensor will only operate when the smart key is within 0.7~1 m (28~40 in.) from the outside door handle.
- Touching the door handle touch sensor does not unlock the doors. To unlock the doors, refer to the following page.

Note that you cannot lock your vehicle using the door handle touch sensor if any of the following occur:

- The Smart Key is in the vehicle.
- The Start/Stop button is in ACC or ON position.
- Any of the doors are open except for the liftgate.

WARNING

Do not leave the Smart Key in your vehicle with unsupervised children. Unattended children could press the Start/ Stop button and may operate power windows or other controls, or even make the vehicle move, which could result in serious injury or death.

Information

- To fold/unfold the rearview mirror simultaneously when the door is locked/unlocked, select 'Settings → Vehicle → Convenience → Welcome Mirror → Enable on Door Unlock' in the infotainment screen.
- The door handle button will only operate when the smart key is within 0.7~1 m (28~40 in.) from the outside door handle. Other people can also open the doors without the smart key in possession.
- After unlocking the doors, the doors will lock automatically after 30 seconds unless a door is opened.

For detailed information, refer to the separately supplied infotainment system manual.

Unlocking your vehicle

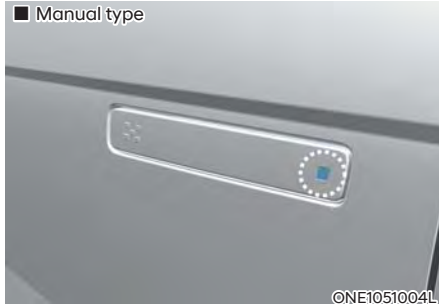

To unlock your vehicle using the door handle button or the Smart Key:

1. Make sure you have the smart key in your possession.
2. Pushing the button on the door handle(engraved part) or press the Door Unlock button (2) on the smart key. All doors handles will be unlocked and the hazard warning lights will blink twice.
3. After unlocking the doors, the doors will automatically re-lock after 30 seconds unless a door is opened.

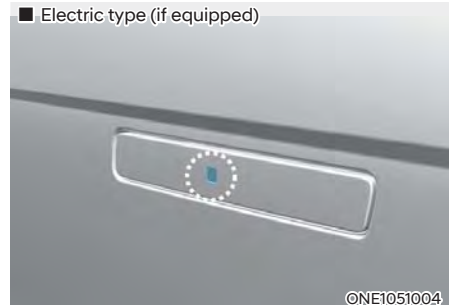

When you release the Two Press Unlock function

To unlock your vehicle using the door handle touch sensor or the Smart Key:

1. Make sure you have the smart key in your possession.
2. Touch the touch sensor on the door handle(engraved part) or press the Door Unlock button (2) on the smart key. All door handles will pop out and the doors will be unlocked and the hazard warning lights will blink and the chime will sound.
3. After unlocking the doors, the doors will automatically re-lock after 30 seconds unless a door is opened.

When you set the Two Press Unlock function

1. Make sure you have the smart key in your possession.
2. Touch the touch sensor on the door handle(engraved part) or press the Door Unlock button (2) on the smart key. The driver's door handle will pop out and the driver's door will be unlocked.
3. Touch the touch sensor on the door handle(engraved part) or press the Door Unlock button (2) on the smart key within 4 seconds again. All door handles will pop out and the doors will be unlocked and the hazard warning lights will blink twice and the chime will sound.
4. After unlocking the doors, the doors will automatically re-lock after 30 seconds unless a door is opened.

Two Press Unlock Feature

The priority for unlocking the driver door only, or unlocking all the doors with one press may be adjusted in the User Settings menu in the LCD cluster display.

The Two Press Unlock feature, when enabled, will require the user to press the door unlock button once for driver door only and twice for unlocking all the doors.

Select or Deselect the Two Press Unlock Feature in the User Settings menu in the LCD cluster display. The option can be found under the following menu:

USER SETTINGS → DOOR → TWO PRESS UNLOCK

The Two Press Unlock Feature can also be enabled or disabled by pressing the door lock and unlock buttons simultaneously on the Key FOB:

Press and hold both the DOOR LOCK button and the DOOR UNLOCK button simultaneously until the hazard warning lights blink.

This will enable or disable the Two Press Unlock feature. Repeat this procedure to enable/disable the mode again.

i Information

- The side view mirror will unfold if 'Enable on Door Unlock' is selected from the Settings menu in the infotainment system screen. Select:
 - Setup → Vehicle Settings → Convenience → Welcome Mirror → Enable on Door Unlock
- The door handle touch sensor will only operate when the smart key is within 0.7~1 m (28~40 in.) from the outside door handle.
- The doors may lock or unlock if the touch sensor of the outer door handle is recognized while washing your car or due to heavy rain.
- To prevent unintentional door lock or unlock:

Press the lock button on the smart key and immediately press the unlock button along with the lock button for more than 4 seconds. The hazard warning lights will blink four times. At this time, the doors will not lock or unlock even though the touch sensor is touched on the outside door handle.

To deactivate the function, press the door lock or unlock button on the smart key.
- The doors may not lock or unlock in the following situations.
 - If the touch sensor is touched with gloves on
 - If the door is suddenly approached

i Information

During a car wash or rain, in order to minimize unintentional operation of the touch sensor, the touch sensor may become insensitive. This is not a malfunction.

Opening the liftgate

To open the liftgate:

1. Make sure you have the smart key in your possession.
2. Press the liftgate open/close button (3) on the vehicle or press and hold the Liftgate handle switch on the smart key for more than one second. The hazard warning lights will blink two times and the liftgate will open.

i Information

The liftgate open/close button will only operate when the smart key is within 0.7 m (28 in.) from the liftgate.

Remotely opening and closing the charging door

To open charging door remotely:

Press the Charging Door Open/Close button (4) for more than one second, or press the charging door open/close button in the vehicle while carrying the smart key.

To close the charging door:

Press the Charging Door Open/Close button (4) for more than a second while the door is open, or press the charging door open/close button in the vehicle while carrying the smart key when the charging door is opened.

Remotely initiating electricity charging

To remotely start charging the vehicle:

Press the charging door open/close button in the smart key while the charging connector is connected to the vehicle.

For more details, refer to “Charging Electric Vehicle” section in chapter 1.

Remotely starting vehicle

You can start the vehicle using the Remote Start button (5) on the smart key.

To start the vehicle remotely:

1. Press the door lock button on the smart key within 10 m (32 feet) from the vehicle.
2. Press the Remote Start button (5) for more than 2 seconds within 4 seconds after pressing the door lock button.
3. The hazard warning lights will blink and the vehicle will start.
4. To turn off the remote start function, press the Remote Start button (5) once.

Information

- **The vehicle must be in P (Park) for the remote start function to start.**
- **The vehicle turns off if you get on the vehicle without a registered smart key.**
- **The vehicle turns off if you do not get on the vehicle within 10 minutes after remotely starting the vehicle.**
- **The Remote Start button (5) may not operate if the smart key is not within 10 m (32 feet).**
- **The vehicle will not remotely start if the vehicle hood or liftgate is opened.**

Remotely moving vehicle forward or backward (if equipped)

With the smart key, the driver can move the vehicle forward or backward using the Forward or Backward button (6, 7) on the smart key.

For more details, refer to “Remote Smart Parking Assist (RSPA)” section in chapter 7.

Start-up

You can start the vehicle without inserting the key.

For more details, refer to the “Start/ Stop Button” section in chapter 6.



Information

If the smart key is not moved for some time, the detection function for smart key operation will pause. Lift the smart key to activate the detection again.

NOTICE

To prevent damaging the smart key:

- **Keep the smart key in a cool, dry place to avoid damage or malfunction. Exposure to moisture or high temperature may cause the internal circuit of the smart key to malfunction which may not be covered under warranty.**
- **Avoid dropping or throwing the smart key.**
- **Protect the smart key from extreme temperatures.**

Mechanical key

If the Smart Key does not operate normally, you can lock or unlock the driver’s door by using the mechanical key.

To remove the mechanical key from the smart key FOB:

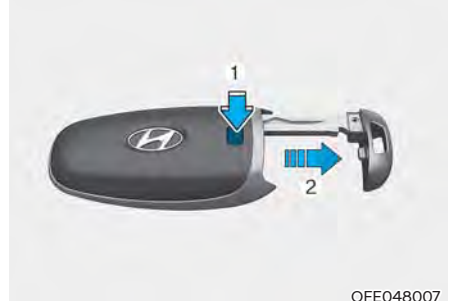

1. Press the mechanical key and remove it from the smart key FOB.
2. Move the release lever in the direction of the arrow (1) and then remove the mechanical key (2). Insert the mechanical key into the key hole on the door.

To reinstall the mechanical key, put the key into the hole and push it until a click sound is heard.

Loss of a smart key

A maximum of three Smart Keys can be registered to a single vehicle. If you happen to lose your smart key, it is recommended that you should immediately take the vehicle and remaining keys to your authorized HYUNDAI dealer or tow the vehicle, if necessary.

Smart key precautions

The smart key may not work if any of the following occur:

- The smart key is close to a radio transmitter such as a radio station or an airport which can interfere with normal operation of the transmitter.
- The smart key is near a mobile two way radio system or a mobile phone.
- Another vehicle's smart key is being operated close to your vehicle.

If the smart key does not work correctly, open and close the door with the mechanical key. If you have a problem with the smart key, contact an authorized HYUNDAI dealer.

If the smart key is in close proximity to your mobile phone, the signal could be blocked by your mobile phone's normal operational signals. This is specifically relevant when the phone is active such as making and receiving calls, text messaging, and/or sending/receiving emails. When possible, avoid keeping the smart key and your mobile phone in the same location such as a pants or jacket pocket in order to avoid interference between the two devices.

i Information

Changes or modifications not expressly approved by the party responsible for compliance could void the user's authority to operate the equipment. If the keyless entry system is inoperative due to changes or modifications not expressly approved by the party responsible for compliance, it will not be covered by your manufacturer's vehicle warranty.

i Information

This device complies with Part 15 of the FCC rules.

Operation is subject to the following three conditions:

- 1. This device may not cause harmful interference, and**
- 2. This device must accept any interference received, including interference that may cause undesired operation.**
- 3. Changes or modifications not expressly approved by the party responsible for compliance could void the user's authority to operate the device.**

NOTICE

- **Keep the smart key away from electromagnetic materials that blocks electromagnetic waves to the key surface.**
- **Always have the smart key with you when leaving the vehicle. If the smart key is left near the vehicle, the vehicle battery may be discharged.**

Battery replacement

If the Smart Key is not working properly, try replacing the battery with a new one.

Battery Type: CR2032

To replace the battery:



OFE048009

If the Smart Key is not working properly, try replacing the battery with a new one.



ODN8059266

Battery Type: CR2032

To replace the battery:

1. Remove the mechanical key.
2. Use a slim tool to pry open the rear cover of the smart key.
3. Remove the old battery and insert the new battery. Make sure the battery position is correct.
4. Reinstall the rear cover of the smart key.

If you suspect your smart key might have sustained some damage, or you feel your smart key is not working correctly, contact an authorized HYUNDAI dealer.

WARNING

THIS PRODUCT CONTAINS A BUTTON BATTERY.

If swallowed, a lithium button battery can cause severe or fatal injuries within 2 hours. Keep batteries out of reach of children.

If you think batteries may have been swallowed or placed inside any part of the body, seek immediate medical attention.

Information



An inappropriately disposed battery can be harmful to the environment and human health. Dispose of the battery according to your local law(s) or regulations.

Immobilizer System

The immobilizer system helps protect your vehicle from theft. If an improperly coded key (or other device) is used, the vehicle is disabled.

When the Start/Stop button is pressed to the ON position, the immobilizer system indicator should come on briefly, then go off. If the indicator starts to blink, the system does not recognize the coding of the key.

Press the Start/Stop button to the OFF position, then press the Start/Stop button to the ON position again.

In some circumstances, the vehicle may not recognize your smart key if another smart key device is nearby or a metal object such as a key chain is causing interference with the smart key.

If this occurs, your vehicle may not start. Remove any metal objects or additional keys near the smart key before attempting to start the vehicle again.

If the system repeatedly does not recognize the coding of the key, contact an authorized HYUNDAI dealer.

Do not attempt to alter this system or add other devices to it. Electrical problems could result that may make your vehicle inoperable.



WARNING

In order to prevent theft of your vehicle, do not leave spare keys anywhere in your vehicle. Your immobilizer password is a customer unique password and should be kept confidential.

NOTICE

The transponder in your key is an important part of the immobilizer system. It is designed to give years of trouble-free service, however you should avoid exposure to moisture, static electricity and rough handling. Immobilizer system malfunction could occur.



Information

This device complies with Part 15 of the FCC rules.

Operation is subject to the following three conditions:

- 1. This device may not cause harmful interference.**
- 2. This device must accept any interference received, including interference that may cause undesired operation.**
- 3. Changes or modifications not expressly approved by the party responsible for compliance could void the user's authority to operate the device**

Hyundai Digital Key (if equipped)

Digital Key Application

To use Hyundai Digital Key mobile app, you should install Hyundai digital key application. Search 'Hyundai digital key' in the Google Play Store and download the app. Please refer to the detailed manual of the digital key app. The option can be found under the following app menu:

Menu → Application Info → Tutorial

Please note the manual before using the app.

- * This service is only available for Android smartphones. Please confirm supported/compatible devices on our website.



WARNING

For used vehicle

If any of the digital key (smartphone key or card key) is already registered when you press ON button after unlocking the doors, the message 'Digital key(s) active' appears on the instrument cluster once. If you buy a used vehicle, you should confirm the message and delete the registered smartphone key and card key. In addition, please notify the Hyundai Customer Care Center.

If the card key does not work properly, please delete the card key and register the smartphone key and re-register the card key.

For vehicle maintenance

If you need to have your Digital Key System repaired or replaced please ensure your Smartphone Key is still active. You may have to pair your phone again.

In the case, re-initialize your Digital Keys using the Hyundai Digital Key mobile app.

Digital key (smartphone) NFC function

You can use the Digital Key NFC (Near Field Communication) function after turn your smartphone NFC settings on. And you should unlock & turn on smartphone screen to use it.

- * To change the NFC mode of the smartphone, please refer to the smartphone manual or contact to the customer service center of smartphone manufacturers.

Digital key (smartphone)

Hyundai Digital Key (Smartphone) Pairing

1. Turn the vehicle on with the Smart key and make sure to keep the smart key inside the vehicle during digital key registration.

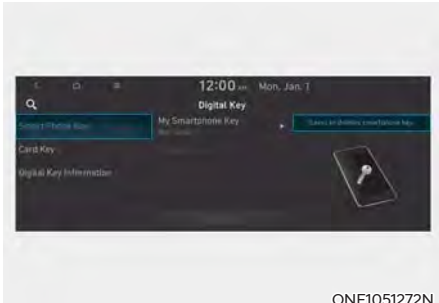

2. Register your Digital key from the vehicle user setting menu as follows. From the infotainment screen menu, go to [Setup] - [Vehicle] - [Digital Key] - [Smart Phone Key] then select the [Save] from submenu.

i Information

The [Save] button will be disabled if the digital key (Smartphone key) is already saved.

Please refer to “Digital Key Delete” in this manual and follow the digital key delete procedure in your car before Digital key save.

Please refer to the ‘Tutorial’ on your Digital key app and delete the previous saved key in your smartphone before save.

3. Select the vehicle to save on your Digital key application and activate the save mode.
- * Save mode is available only on the vehicle owner’s Digital key application.
4. Place the backside of smartphone onto the wireless charging pad (in-vehicle authentication pad). The saving process will begin automatically.
5. Once the digital key save is complete, a message will be shown on the infotainment screen or cluster.
6. Remove the smartphone from the pad and complete the saving process.



[A] : Wireless Charging Pad (In-vehicle Authentication Pad)

Hyundai Digital Key (Smartphone Key) Deletion

1. Turn the vehicle on with the Smart key and make sure to keep the smart key inside the vehicle during delete process.



2. Delete your Digital key from the vehicle user setting menu as follows. From the infotainment screen menu, go to [Setup] - [Vehicle] - [Digital Key] - [Smart Phone Key] then select the [Delete] from submenu.

i Information

The [Delete] button will be disabled if there is no digital key (Smartphone key) saved.

3. Once the digital key delete is complete, a message will be shown on the infotainment screen or cluster.
4. Go to [Initialize Digital Key] menu on the digital key application and select the vehicle to delete the digital key information.
 - Open the Hyundai Digital Key app → Menu → Initialize Digital Key
 - * If the saved digital key information in your car is deleted due to vehicle maintenance, the digital key in your smartphone should be deleted as well.
 - * For more information, please refer to the 'Tutorial' on your Digital key app.

⚠ CAUTION

- If the smartphone is removed from the interior authentication pad during enrollment, the saving process will be cancelled.
- If the infotainment or instrument cluster screen is changed during enrollment, the saving process will be cancelled.
- If the vehicle is turned off during enrollment, the saving process will be cancelled.
- If the gear is shifted, the saving process will be cancelled.
- If you try to save the smartphone which is not logged in with the vehicle owner's ID or if you try to save the Card key, the saving process will not begin.
- If the NFC setting on your smartphone is off, the saving process will not begin.
- If the smartphone screen is changed to off or locked status, the saving process will be cancelled.
- If there is no Smart key during the save process, the saving process will not begin.

Set up main vehicle

You can manage multiple digital keys from the Digital key app. From the list of digital keys you own, select the vehicle you want to make your priority vehicle.

For more information, please refer to the 'Tutorial' on your Digital key app.



[A] : Door handle authentication pad

[B] : NFC Antenna in the rear side of smart phone

NFC door lock/unlock

You should contact your smartphone's NFC antenna (backside of phone) to door handle authentication pad (A) marked position near by the lock button) of driver's (or front passenger's) outside door for 2 seconds to lock or unlock the doors. If the Two Press Unlock feature is applied (press twice for unlocking), driver's seat door will be unlocked by contacting the digital key (smartphone key). In this state, if you contact one more time within 4 seconds, all the doors unlock. Please make sure the doors are locked. If you do not open any of the doors after unlocking, it automatically re-lock after 30 seconds.

Note that you cannot lock your vehicle when you contact NFC antenna in the smartphone to the door handle pad if any of the following occurs:

- The Proximity / Smart Key is in the vehicle.
- The Engine Start/Stop button is in ACC or ON position.
- Any of the doors, hood and trunk is opened.

If the smartphone digital key does not work, please remove the smartphone more than 4 inches (0.1 m) from the door handle authentication pad and try it again.

After unlock the door or start up the vehicle with digital key, even though the driver tries to lock the doors by the central door lock switch, the door lock will be once locked and immediately released at the moment of door closed.

Start-up with Digital Key

1. After placing your registered smartphone onto the interior authentication pad (wireless charger), step on the brake and press the Engine Start/Stop button.
2. After start-up, the digital key data will be automatically updated. It takes 5 to 20 seconds, after that, the smartphone can be go into the wireless charging mode automatically. Once the engine started, you can remove the smartphone from the pad.



[A] : Wireless Charging Pad (In-vehicle Authentication Pad)

i Information

After reconnecting the vehicle battery power supply or charging the battery, it may take time to operate due to remote renewal of security information. When you lock or unlock the door with NFC, please contact and hold your smartphone on the door handle until it works.

The solution allows for offline mode usage when the mobile data connection of the smartphone is weak. When you are in the place where the mobile data connection of your smartphone is available and place your smartphone on the interior authentication pad (wireless charger) and start up your vehicle or contact the digital key on the door handle to lock or unlock the door, the remote renewal of security information starts automatically. Even though the engine is turned on, please wait until the remote renewal process is completed and wireless charger is converted to charging mode.

⚠ CAUTION

The engine can be turned on if the registered smartphone or card key is placed on the interior authentication pad (wireless charger). Do not leave unsupervised children or people who are not aware of the system since it can result in serious injury or death. Always have the registered digital key (smartphone) or card key with you to prevent vehicle theft when leaving the vehicle.

For more information, refer to the Engine Start/Stop button in chapter 6.

Remote Control with Digital Key

To use the remote control function with your android smartphone, Bluetooth must be turned on.

Remote Control Connection with Digital Key

1. Open Hyundai digital key application on the smartphone. Select the vehicle to activate the remote control function as a main vehicle.
2. Approach with the activated smartphone app to your vehicle and you can check whether the connection is available. If it enables your smartphone to connect, connect with your vehicle by pressing the connect button. The remote control function is activated after completing the process.

Remote Control Operation with Digital Key

You can execute the remote control operation including door lock/unlock, panic on/off, remote start / remote stop and trunk opening. The icon for each function will be highlighted and alarm/vibration also provided when the operation is performed.

Note that you cannot lock your vehicle using the Hyundai digital key app if any of the following occurs:

- The Engine Start/Stop button is in ACC or ON position.
- Any doors are open.

When the smartphone and the vehicle are connected by the Bluetooth function but the remote control command cannot be received over 5 minutes, the remote control connection is cancelled automatically.



CAUTION

- If metallic window tint was applied to your vehicle, it may cause bad Bluetooth connection or performance degradation of the digital key.
- If multiple users operate the remote control function simultaneously, the connection between the digital key and the vehicle might result in failed commands. Please connect and operate the remote control function only the necessary user.
- When using the remote control operation, the driver (the remote control user) should leave the vehicle after confirming the door lock (the chime sounds once and the hazard warning lights blink).
- The remote functions of the Digital Key app enables the vehicle to be controlled from a set distance. If the digital key or the vehicle goes beyond the operable distance, the remote control function might be disconnected or cancelled.
- If the digital key (smartphone) is connected with the vehicle for the remote control, the driver with the key goes far away from the vehicle, the function might not work.
- If the remote control operation is executed where the mobile connection is weak, Bluetooth connection is poor due to several Bluetooth devices or there is an object such as metal or concrete, it might be delayed or the operable distance might decrease. You should not cover the smartphone with your hand or place other devices which can cause frequency interference. It may result in poor performance.
- If the remote control function is not available, please use NFC function to lock or unlock the doors.

Remote Start with Digital Key

- When the shift button of your vehicle is in P (Park) and all of the doors including trunk and hood is locked and the vehicle is off, press the Door Lock button in the Hyundai Digital Key app then press the Remote Start button within 4 seconds.
You can confirm the engine is on if the hazard warning lights blinks two times and the chime sounds.
- If you want to turn off the engine, press Remote Engine Stop. Air Conditioner / Heating system maintains the same status as when you last used the vehicle.
- Unless you put the registered digital key (smartphone) on the interior authentication pad (wireless charger) when the remote start function is on, the engine will turn off.
- If you do not get on the vehicle within 10 minutes after the engine turns on, the vehicle will turn off.

For more information, refer to the Engine Start/Stop button in chapter 6.

Vehicle information Display

The digital key application displays the vehicle information such as driving or door conditions through the communication with the vehicle.

- How to check : Select the vehicle what you want to check and touch the vehicle image, then vehicle information display page will be shown.
- Contents : accumulated odometer, latest fuel economy, driving range, fuel remaining, tire pressure, doors lock/unlock status and last data updated time.
- * Displayed vehicle date could be differed from the current vehicle condition.
- * **For more information, please refer to the 'Tutorial' on your Digital key app.**

Smartphone change/App deletion

If you change your smartphone or delete the Hyundai Digital Key App, please refer to the following to set up your Digital Key:

Smartphone Change/ Reset

If you change or reset the smartphone, the registered digital key in your previous smartphone may not be used. Please refer to following procedure to use the digital key.

1. Install the digital key application and log in.
2. If you are the owner, retry the Digital key save process.
3. If you are the sharer, need to re-share the key from owner.

App delete & reinstall/ Delete App data

You can re-download the digital key from server in these cases as follow procedure.

1. Reinstall the application and log in.
2. Input the PIN number for user verification.
3. If PIN is correct, digital key data will be re-downloaded to your smartphone and you can use it without any further registration or sharing.

Smartphone operability with Digital Key

The digital key application may not be available to old type smartphones. Please check the available smartphone models with your dealer. NFC antenna position on the smartphone can be confirmed on each smartphone's manual or contact to customer service center of the smartphone manufacture.



CAUTION

- Do not leave the registered digital key (smartphone) and card key in your vehicle. Please carry around your keys all the times.
- If you happen to lose your digital key (smartphone) or card key registered as a main user's key, you should immediately delete the key on the vehicle's key menu. For more information, refer to the Digital Key Deletion in this chapter.
- If you registered your digital key (smartphone) or card key in the vehicle, a message appears on the instrument cluster and let you know the key is registered. (Message: Digital key(s) active.)
- If you buy a used vehicle, you should confirm the message and delete the registered smartphone key and card key. In this case, you should carry your smart key.
- If you keep place the NFC card of the digital key on the interior authentication pad (wireless charger) while driving, it may cause a malfunction of the NFC card.
- You should remove your NFC card of the digital key on the interior authentication pad after turning on the engine.
- Hyundai digital key app may not work properly when the NFC or Bluetooth communication between smartphone and car is not good.
- If the remote control operation is executed where the mobile connection is weak, Bluetooth connection is poor due to lots of Bluetooth devices or there is an object such as metal or concrete, it might be delayed or the operable distance might decrease. Especially, you should not cover the smartphone with your hand or place other devices which can cause frequency interference. It may result in poor performance.
- If the remote control function is not activated, please use NFC function to lock or unlock the doors
- You should be careful not to press the remote control button on the digital key (smartphone) accidentally.
- If the digital key (smartphone) is discharged or defective or you cannot use the digital key since the vehicle battery is discharged, use the inside door lock button to lock all of the doors.



CAUTION

- Hyundai digital key app on the smartphone and card key may not work if any of the following occurs:
 - Hyundai digital key app on the smartphone is deleted. (Required to reinstall the app)
 - Account log in information of Hyundai digital key app is expired. (Required to re-log in)
 - When you try to log in to another smartphone instead of the registered smartphone with same user account.
 - Smartphone rooting or app hacking is detected.
 - Smartphone battery or the vehicle battery is discharged.
 - Smartphone's screen is off or locked.
 - NFC or Bluetooth is turned off on the smartphone settings.
 - Smartphone's mobile network setting is off or airplane mode is activated.
 - A credit card is overlapped in the back of your smartphone or metal or thick case is used.
 - Use the card key with insert it into the wallet or card holder or overlapping with other cards.
 - If you use a smart phone cover that uses wireless communication or is made of metal, the digital key NFC function may not work properly. Remove the smart phone cover before using the digital key NFC function.
- The vehicle may not be controlled by the smartphone if any of the following occurs:
 - Basic and necessary functions of the smartphone manufacturer are operating. (General call, urgent call, audio or NFC payment)
 - Wireless earphone is operating. (General call, urgent call or audio)
 - The digital key app function such as basic setting or app launching is limited by prior policy according to the manufacturer while using a smartphone produced by domestic and foreign manufactures.
- * If you change the smartphone number, you should modify the user account information on the HYUNDAI customer web site to use the digital key app.
- * If the vehicle owner changes the smartphone device, the new smartphone should be registered in the car after deleting the registered digital key(smartphone).
- * If a sharer changes or reset the smartphone, the key should be re-shared from owner.
- * Some of the old smartphone may not work properly. Please check the available smartphone models with your dealer.
- * NFC antenna position on the smartphone can be confirmed on each smartphone's manual or contact to customer service center of the smartphone manufacture.

Digital key (Card key)

Digital key (Card key) save

1. Install Hyundai digital key app in main user's smartphone and register the digital key (smartphone). Please refer to the registration method of the digital key (smartphone).
2. Using the [Pair Card Key] menu on the digital key application, you can activate the Card Key registration mode.
 - * NFC authentication : enter the NFC authentication menu and contact the smartphone on the outside door handle.
 - * Bluetooth authentication : enter the Bluetooth authentication menu and press the [OK] button for activation.
If you activate the registration mode, you should complete the Card saving process within 5 minutes.
 - * If you have not registered the digital key (smartphone), please register the digital key (card key) with two smart keys.

3. Register the NFC card key on the User's Settings menu after turning on the vehicle.

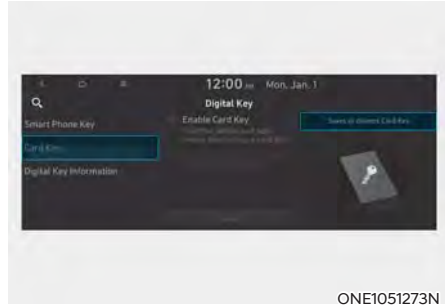

From the infotainment screen menu, go to [Setup] - [Vehicle] - [Digital Key] - [Card Key] then select the [Save] from submenu.

The [Save] button will be disabled if the digital key (Card key) is already saved.

Please refer to “Digital Key Delete” in this manual and follow the digital key delete procedure in your car before Digital key save.

4. Place the NFC card key onto the interior authentication pad (wireless charger). The saving process will begin automatically.
5. If the key is enrolled, the message will be displayed on the infotainment screen or instrument cluster.
 - Once the card key registration mode is activated, the process should be completed within 5 minutes. After then, you should reactivate once again for registration.
 - For the digital key(card key) saving, the smart key(fob) must be exist inside of vehicle.
 - Once a Card key is registered, it cannot be reuse onto another vehicle.

Digital key (Card key) deletion

You should have the smart key to delete the digital key (card key) so please carry around the key.

1. Get on the vehicle with the smart key.
2. Delete the NFC card key on the User's Settings menu after turning on the engine.

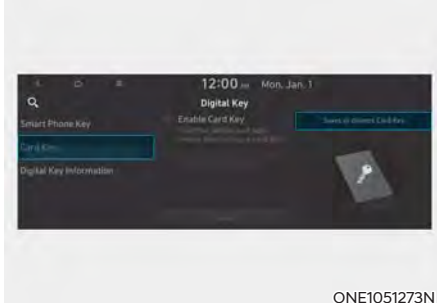

From the infotainment screen menu, go to [Setup] - [Vehicle] - [Digital Key] - [Card Key] then select the [Delete] from submenu.

If there is no saved digital key(card key), [Delete] menu will not be activated.

- To delete the saved digital key (card key), the smart key must be exist inside the vehicle.
- The deleted digital key (card key) can be re-registered before registering a new digital key (card key).
- If you try to register a new digital key (card key), the previously registered digital key (card key) cannot be used again.

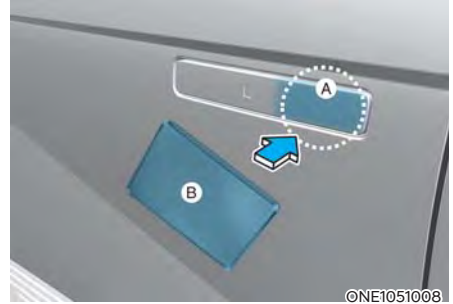

[A] : Door handle authentication pad

[B] : NFC Antenna of the card key

NFC door lock/unlock

You should contact digital key (card key) to door handle authentication pad (1, marked position near by the lock button) of driver's (or front passenger's) outside door for 2 seconds to lock or unlock the doors. If the Two Press Unlock feature is applied (press twice for unlocking), driver's seat door will be unlocked by contacting the digital key (card key). In this state, if you contact one more time within 4 seconds, all the doors unlock.

Inoperable condition

If you do not contact the digital key (card key) to the center of the door handle authentication pad accurately, it may not work. In addition, if you overlap and use the key with NFC-enabled cards such as transportation card or credit card, it does not work.

Note that if you try to lock your vehicle with digital key (card key) in following cases, the doors will not be locked and chime will sound for 3 seconds.

- The Smart Key is in the vehicle.
- The Engine Start/Stop button is in ACC or ON position.
- Any of the doors, hood and trunk are open

If the digital key (card key) does not work, please detach the key around 4 inches (0.1 m) from the handle authentication pad and retry to contact. The card key may be damaged by the impact. It would not work properly if the key is damaged. You should buy a new card and register again. Long-time exposure to high temperature may cause the card key to malfunction. Please be careful not to expose the key to direct sunlight or high temperature.

After unlock the door or start up the vehicle with digital key, even though the driver tries to lock the doors by the central door lock switch, the door lock will be once locked and immediately released at the moment of door closed.

Start-up with Card key

After placing your registered card key onto the interior authentication pad (wireless charger), step on the brake and press the Engine Start/Stop button.



WARNING

- **If you do not place the digital key (card key) onto the center of the interior authentication pad (wireless charger) exactly, the card key may not be recognized. If the engine is not turned on, adjust and place the key again.**
- **If you overlap and use the key with NFC-enabled cards such as transportation card or credit card, the card key may not be recognized.**
- **If the digital key (card key) does not work, please detach the key around 4 inches (0.1 m) from the handle authentication pad and retry to contact.**
- **The card key may be damaged due to impact. It would not work properly if the key is damaged. You should buy a new card and register again.**

For more information, refer to the Engine Start/Stop button in chapter 6.

Digital key application/cancellation

If you do not want to use the digital key (smartphone and card key), you can disable the function temporarily. You should have the smart key when you change the settings

From the infotainment screen menu, go to [Setup] - [Vehicle] - [Digital Key] - [Enable Digital Keys] (deselect)



Information

For the digital key disable, the smart key must be exist inside the car. For the digital key enable, the smart key is not needed.



CAUTION

If you uncheck Enable digital keys, it is impossible to lock or unlock the doors or start up the vehicle with digital keys such as smartphone and card key. If you check Enable digital keys again, the registered digital keys (smartphone and card key) are available. Even though you stop the digital key function, the registered keys (smartphone and card key) are not deleted.

Personalized profile and vehicle settings

Connect the registered digital key with personalized profile. Then in case you lock or unlock the door with the digital key NFC function or unlock the door remotely by digital key application Bluetooth connection, the vehicle will play the personalized user profile settings. Profile connection and personalization are available for Driver 1 and Driver 2.

Profile link/unlinked

Profile link

1. Select Setup → User Profile → Profile Settings → Link Digital Key (Smartphone) on the infotainment system menu.
2. Unlock and place your smartphone on the wireless charger according to a message and it automatically starts to interwork.
3. It begins the profile link with a message.
4. If you select Link, the registered phone number's digital key and the user's profile are linked.
5. The interconnection process is completed with a message.

Profile unlink

1. Select Digital Key information on infotainment Vehicle Settings menu. It is possible to unlink only if the profile is interconnected.
2. Profile unlink is completed with a message.

i Information

If you connect both Driver 1 and Driver 2 with a single smartphone, the smartphone digital key always works as Driver 1.

If you unlink the Driver 1, personalization function will operate as Driver 2.

PRECAUTION for vehicle profile link and unlink

When you link or unlink the profile of digital key, you should be careful of the following.

- Profile link is possible to use with the digital key. (Infotainment Vehicle Settings Mode → Digital Key → Enable Digital Keys)
- Profile link information remains even when you set the digital key function disable.
- Only the smart phone with digital key app enables you to link your profile. (Impossible to link with NFC card)
- Profile link works only when the smart phone and the digital key are registered to the vehicle. The smart phone with another vehicle's digital key cannot link profile.
- If you remove the smart phone from the wireless charger before completing the profile link, it does not work.
- To unlink the profile, the smart phone does not need to be on the wireless charger.

Vehicle personalization operation

The personalization function linked with digital key works as following conditions:

- Contact the driver's door handle with the profile linked smart phone to lock or unlock the doors (Personalization does not operate when locking or unlocking the front passenger door.)
- Remote door unlock with the profile linked smartphone digital key app.

The profile linked with digital key can be changed manually in the infotainment system setup screen.

Precaution for digital key profile link and unlink

Profile operation according to door lock/unlock system is as follows.

Item	Personalization Operation
Initial value	Guest
Profile linked smart phone key	Linked profile
Profile unlinked smart phone key	Recently activated profile
NFC card key	
Smart key	

- The personalization function using the digital key can be operated after linking the digital key on the infotainment system profile menu.
- You should use the personalization function during stopping your vehicle safely.

Vehicle personalization with digital key

The available personalization function in the vehicle is as follows.

System	Personalization Item	
USM	HUD	Display mode, Display control, AR matching adjustment, Content selection
	Lamp	Blink number of one-touch signal lamps
	Cluster	Information display on the cluster, Voice volume, Welcome sound, Theme selection
	Seat/Mirror	-
	Door	Automatic door lock/unlock, Two Press Unlock
	Air conditioning	Temperature unit, shut off outside air (interlocked with washer fluid), Automatic ventilation, Auto defogging on/off
	Convenience	Wireless charging system on/off
	NFC	Digital key on/off, Smartphone Key Paring/Deletion, Card key Save/Delete
AVN	Navigation	Preferred volume of the navigation system, Recent destination
	User preset	Radio preset
	Phone connectivity	Bluetooth preferential connect CarPlay/Android Auto/MirrorLink On/Off
Air conditioning	Operating condition	Latest operation setup of the following functions: Temperature, AUTO, air flow direction, air volume, air conditioner, air intake control, SYNC, Front windshield defroster, OFF
Driving	Smart mode	-

For more information of personalization, refer to the infotainment system manual.



CAUTION

If you leave the digital key after locking or unlocking the doors or starting up the vehicle with the smart key, the doors can be locked by the central door lock. Please carry around the digital key all the time.

DOOR LOCKS

Operating Door Unlocks from Outside the Vehicle (Manual type)

Smart key



Push the button on the front outside door handle (the engraved part) while carrying the Smart Key with you, all doors will unlock.

The hazard warning lights will blink twice and chime also sounds twice.

Once the doors are unlocked, when press the front of the door handle (1) then rear of the door handle will pop out (2).

Pull the outside door handle to open the door.

Operating Door Unlocks from Outside the Vehicle (Electric type) (if equipped)

Smart key

Approach unlock system

The outside door handle will slide out and the doors will unlock when the driver approaches the vehicle possessing the smart key.

The driver can activate/deactivate the “Approach unlock” system on the infotainment screen.

To activate Approach unlock system for only the driver’s seat, select ‘Settings → Vehicle → Door → Remote power door open → Unlock all doors’ in the infotainment system screen.

To activate Approach unlock system, select ‘Settings → Vehicle → Door → activate approach unlock’ in the infotainment system. The outside door handle will slide out and the door will unlock when the driver approaches the vehicle possessing the smart key. If Approaching unlock system is deactivated, the door handle will not slide out even when the driver approaches to the vehicle with the smart key. To unlock doors when Approach unlock system is deactivated, touch the lock/unlock sensor(engraved part) on the handle.



- When the “Approach unlock” is activated :
 - If you approach (within 1 m) the driver or front passenger’s door handle possessing the smart key, the outside door handles slide out and the doors are unlocked. In this case, Hazard Warning Flasher blinks twice and chime also sounds twice.
 - After first approach, the vehicle tries detecting the smart key every 5 seconds and if the key is not detected, the doors will lock automatically and the handles will slide in.
- When the “Approach unlock” is deactivated : The handle does not slide out even when you approach with the smart key in possession. The doors are unlocked if you press the outside handle as the handles slide out.
- The doors will lock automatically and the handles will slide in after 30 seconds unless a door is opened.

i Information

In emergency situations, such as battery is dead, the outside electric door handle can still be operated in a way that the outside manual door handle operate.

Operating Door Locks from Outside the Vehicle (Manual type)

Smart key



Push the button on the front outside door handle (the engraved part) while carrying the Smart Key with you, all doors will lock. The hazard warning lights will blink and chime also sounds once. Push the door to close.

Operating Door Locks from Outside the Vehicle (Electric type) (if equipped)

Smart key

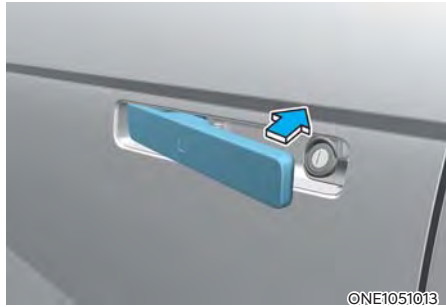

When all doors are closed, touch the touch sensor on the front outside door handle (the engraved part) while carrying the Smart Key with you, outside door handle will return and doors will be locked. The hazard warning lights will blink and chime also sounds once.

NOTICE

- If the door is locked/unlocked multiple times in rapid succession with the smart key, door lock button or door lock switch, the system may stop operating temporarily in order to protect the circuit. Also, the “Approach unlock” system may not operate. Try operation after a sufficient time in case the system does not operate due to multiple operations.
- “Approach unlock” system is not operated continuously. Retry after a certain period of time when all the doors are closed.

i Information

- In cold and wet climates, door lock and door mechanisms may not work properly due to freezing conditions.
- If the door is locked/unlocked multiple times in rapid succession with either the vehicle key or door lock switch, the system may stop operating temporarily in order to protect the circuit and prevent damage to system components.
- When washing the vehicle

- Self car wash

Keep the door locked with the outside door handle closed.

To keep the door unlocked, push back the outside door handle by hand. This function prevents the door handle from being damaged, and the door handle pops out again when the unlock button is pressed.

- Auto car wash

Keep the door locked with the outside door handle closed.

If the Smart Key is not in the vehicle, turn off the vehicle and stay the Smart Key away at least 2 m (78 in.) from the vehicle to prevent the outside door handle operates.

Digital key (if equipped)

Refer to ‘HYUNDAI digital key’ of this chapter to lock or unlock the door from outside vehicle with digital key.

Pull the outside door handle to open the door after unlocking the door. Push the door to close.

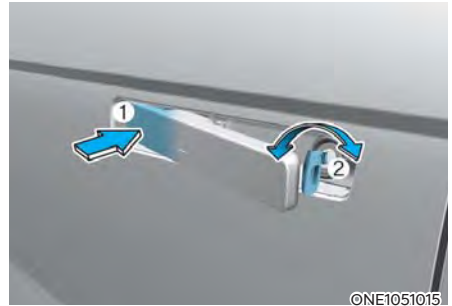
Mechanical key

Press the front part (1) of the door handle to pull out the rear part of the door handle. While keep pressing the front part of the door handle, insert the mechanical key to the lock.

To lock the door, turn the key toward the front (left side) of the vehicle. To unlock, turn the key toward the rear (right side) of the vehicle.

NOTICE

Do not apply excessive force on the door and door handle. It may damage the door and door handle.

The mechanical key only locks/unlocks the driver’s door handle. For more detail, refer to ‘In case of an emergency’ in this chapter.

i Information

When the door handle or the keyhole freeze and do not open, lightly tap or indirectly warm (for example, hand temperature) the keyhole.

Operating Door Lock/Unlock from Inside the Vehicle

With the door handle



Front door

If the inner door handle is pulled when the door is locked, the door will unlock and open.

Rear door

If the inner door handle is pulled once when the door is locked, the door will unlock. If the inner door handle is pulled once more, the door will open.

If any door is opened, the doors will not lock even though the central door lock switch is pressed.

i Information



If a power door lock ever fails to function while you are in the vehicle try one or more of the following techniques to exit:

- Operate the door unlock feature repeatedly (both electronic and manual) while simultaneously pulling on the door handle.
- Operate the other door locks and handles, front and rear.
- Lower a front window and use the mechanical key to unlock the door from outside.

With the central door lock switch



Driver's and front passenger's door

The driver's and front passenger's door armrest is equipped with a central door lock switch. The lock switch is indicated by a  symbol. The unlock switch is indicated by a  symbol.

When the lock switch (1) is pressed (door indicator light ON), all the vehicle doors will lock.

When the unlock switch (2) is pressed, all the vehicle doors will unlock.

If any door is open, the doors will not lock even though the lock switch (1) is pressed.

NOTICE

If the smart key is in the vehicle and the front door is opened, the central door lock button (1) cannot lock the doors.

In case of an emergency

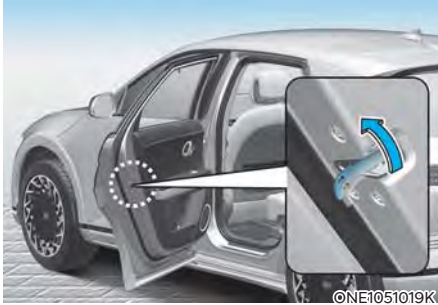

In case of emergency such as when the battery is discharged, the only way to lock the door(s) is with the mechanical key from the outside key hole.

Doors without an outside key hole can be locked as follows:

1. Open the door.
2. Insert the key into the emergency door lock hole and turn the key to the lock position.
3. Close the door securely.

i Information

If the electrical power door lock switch does not operate (ex. dead car battery) and the liftgate is closed, you will not be able to open the liftgate until power is restored.

! WARNING

- The doors should always be fully closed and locked while the vehicle is in motion. If the doors are unlocked, the risk of being thrown from the vehicle in a crash is increased.
- Do not pull the inner door handle of the driver's or passenger's door while the vehicle is moving.

! WARNING

Do not leave the elderly, children or animals unattended in your vehicle. An enclosed vehicle can become extremely hot, causing death or serious injury to the elderly, unattended children or animals who cannot escape from the vehicle. Children might operate features of the vehicle that could injure them, or they could encounter other harm, possibly from someone gaining entry to the vehicle.

! WARNING

Always secure your vehicle.

Leaving your vehicle unlocked increases the potential risk to you or others from someone hiding in your vehicle.

To secure your vehicle, while depressing the brake, shift the gear to the P (Park) position, engage the parking brake, and press the Start/ Stop button to the OFF position, close all windows, lock all doors, and always take the key with you.



CAUTION

Opening a door when something is approaching may cause damage or injury. Be careful when opening doors and watch for vehicles, motorcycles, bicycles or pedestrians approaching the vehicle in the path of the door.



WARNING

If you stay in the vehicle for a long time while the weather is very hot or cold, there are risks of injuries or danger to life. Do not lock the vehicle from the outside when someone is in the vehicle.

Automatic Door Lock and Unlock Features

Your vehicle is equipped with features that will automatically lock or unlock your vehicle based on settings you select in the infotainment system screen.

Auto LOCK Enable on speed

When this feature is set in the infotainment system screen, all the doors will be locked automatically when the vehicle exceeds 9 mph (15 km/h).

Auto LOCK Enable on shift

When this feature is set in the infotainment system screen, all the doors will be locked automatically when the vehicle is shifted out of P (Park) while the vehicle is running.

Auto UNLOCK On Shift to P

When this feature is set in the infotainment system screen, all the doors will be unlocked automatically when the vehicle is shifted back into P (Park) while the vehicle is running.

Auto UNLOCK Vehicle off

When this feature is set in the infotainment system screen, all the doors will be unlocked automatically when the vehicle is turned off.

For detailed information, refer to the separately supplied infotainment system manual.

Additional unlock safety feature air bag deployment

As an additional safety feature, all doors will be automatically unlocked when an impact causes the air bags to deploy.

Electronic Child Safety Lock



When the electronic child safety lock button is pressed and the indicator light on the button illuminates, the rear doors cannot be opened from inside the vehicle.

- The rear door window cannot be opened or closed while the electronic child safety lock button is in the LOCK position (indicator light ON).

For more details, refer to “Windows” section in this chapter.

- Electronic child safety lock does not automatically turn on unless the driver presses the electronic child safety lock button.
- If 3 minutes passes after the Start/Stop button is pressed to the OFF or ACC, the indicator on the button turns off, and the driver cannot turn off electronic child safety lock by pressing the button. To turn off the function, press the Start/Stop button to the ON position, and then press the electronic child safety lock button.

- If the power is supplied again after removing the battery or battery is discharged while the electronic child safety lock button is in the LOCK position, press the button once more to match the state of the indicator on the electronic child safety lock button and actual status of the electronic child safety lock function.
- If the airbag is activated while the electronic child safety lock button is in the LOCK position (indicator light ON), the rear doors will unlock automatically.
- Vehicles equipped with the electronic child safety lock feature is not provided with a manual child safety lock.

WARNING

If children accidentally opens the rear door while the vehicle is in motion, they could fall out of the vehicle. Electronic child safety lock should always be used whenever children are in the vehicle.

NOTICE

Child safety lock failure



ONE1051205L

When electronic child safety lock does not work even though the button is pressed, the message will be displayed and an alarm will sound. If this occurs, have the vehicle inspected by an authorized HYUNDAI dealer.

Safe Exit Assist (if equipped with electronic child safety lock)

Safe Exit Assist helps prevent the rear occupant from opening the rear door. When an approaching vehicle from the rear area is detected after the vehicle stops, the rear doors will not unlock even when the driver tries to unlock the rear doors using the electronic child safety lock button.

For more details, refer to “Safe Exit Assist (SEA)” section in chapter 7.

Vehicle Auto-Shut Off Function

If you forget to turn off the vehicle that EV Drivable for a period of time, Vehicle Shuts Off automatically to prevent waste electric power.

Operating Conditions

Vehicle Auto-Shut Off timer activates when the following conditions are met

- Not Auto-Shut Off timer reset condition
 - Vehicle is not EV ready state(Only Ignition On) or the utility mode on
 - Gear Shift Other than P
 - Stepped on the brake pedal of the accelerator pedal
 - Fastened driver’s seat belt and passenger’s seat belt
 - Passenger `s seat is occupied
 - The vehicle moves(vehicle speed is above 2 mph (3 km/h))
 - When Auto-Shut Off timer is left 10minutes, the user setting mode pops up in the instrument cluster. And you can check the time left. If you push the ‘OK’ button, Auto-Shut off timer is reset.



ODN8A059340

- Head unit is not updating
- Outside of vehicle charging connector engaged or outside V2L used
- If you want to deactivate auto-shut off function during inside V2L, use the Utility mode

System Operation

If the system is satisfied operating conditions after 90 minutes, vehicle shut off automatically.

THEFT-ALARM SYSTEM

This system helps to protect your vehicle and valuables. The horn will sound and the hazard warning lights will blink continuously if any of the following occur:

- A door is opened without using the smart key.
- The liftgate is opened without using the smart key.
- The vehicle hood is opened.

The alarm continues for 30 seconds, then the system resets. To turn off the alarm, unlock the doors with the smart key.

The Theft Alarm System automatically sets 30 seconds after you lock the doors and the liftgate. For the system to activate, you must lock the doors and the liftgate from outside the vehicle with the smart key or by touching the touch sensor or pressing the button on the outside door handle with the smart key in your possession.

The hazard warning lights will blink and the chime will sound once to indicate the system is armed.

Once the security system is set, opening any door, the liftgate, or the hood without using the smart key will cause the alarm to activate.

The Theft Alarm System will not set if the hood, the liftgate, or any door is not fully closed. If the system will not set, check the hood, the liftgate, or the doors are fully closed.

Do not attempt to alter this system or add other devices to it.

Information

- **Do not lock the doors until all passengers have left the vehicle. If the remaining passenger leaves the vehicle when the system is armed, the alarm will be activated.**
- **If the vehicle is not disarmed with the smart key, open the doors by using the mechanical key and start the vehicle by directly pressing the Start/Stop button with the smart key.**
- **If the system is disarmed by unlocking the vehicle, but neither a door or the liftgate is opened within 30 seconds, the doors will relock and the system will rearm automatically.**

ADVANCED REAR OCCUPANT ALERT (ROA) (IF EQUIPPED)

Advanced Rear Occupant Alert is provided to help prevent a driver from leaving a vehicle with the rear passenger left in the vehicle.

System Setting

To use Rear Occupant Alert, it must be enabled from the Settings menu in the infotainment system screen. Select:

- Setup → Vehicle Settings → Convenience → Rear Occupant Alert (ROA)

For detailed information, refer to the separately supplied infotainment system manual.

System Operation

- First alert
When you turn off the vehicle and open the driver's door after opening and closing the rear door or liftgate, the 'Check rear seats' warning message appears on the cluster.



WARNING

Even if your vehicle is equipped with Advanced Rear Occupant Alert (ROA), always make sure to check the rear seat before you leave the vehicle.

Advanced Rear Occupant Alert (ROA) may not operate when:

- **Movement does not continue for a certain period of time or the movement is small.**
- **A child is not seated in a child restraint system.**
- **Movement is detected in areas other than the rear seats.**
- **The rear passenger is covered with a fabric containing metallic substance such as a blanket.**
- **An object in the vehicle blocks the sensor.**
- **The sensor is contaminated by foreign material.**
- **An animal at the rear seat or luggage compartment is not large enough to be detected by the sensor or there is hardly any movement.**
- **Attaching objects or modifying the interior ceiling, or the interior ceiling is deformed or damaged.**
- **There are electronic interference around the vehicle.**
- **Other environmental reasons that may affect the system.**

INTEGRATED MEMORY SYSTEM (IF EQUIPPED)



Integrated Memory System for the driver's seat is provided to store and recall the following memory settings with a simple button operation.

- Driver's seat position
- Side view mirror position
- Head-Up Display (HUD) : display mode, position, AR matching adjustment (if equipped)



WARNING

Never attempt to operate the integrated memory system while the vehicle is moving.

This could result in loss of control, and an accident causing death, serious injury, or property damage.



Information

- If the battery is disconnected, the memory settings will be erased.
- If integrated memory system does not operate normally, have the system inspected by an authorized HYUNDAI dealer.

Storing Memory Positions

1. Shift to P (Park) while the Start/Stop button is in the ON position.
2. Adjust the driver's seat position, side view mirror position, and head-up display height to the desired position.
3. Hold the button (1 or 2). The system will beep once and notify you 'Driver 1 (or 2) settings saved' will appear on the infotainment screen.

Recalling Memory Positions

1. Shift to P (Park) while the Start/Stop button is in the ON position.
2. Press the desired memory button (1 or 2). The system will beep once, and then the driver's seat position, side view mirror position, and head-up display height will automatically adjust to the stored positions.
3. 'Driver 1 (or 2) settings applied' will appear on the infotainment screen.



Information

- In order to adjust the memory button (2) while adjusting the memory button (1), press the memory button (1) to pause the adjustment of (1), then press memory button (2).
- If you adjust the seat, rearview mirror, head-up display while recalling the stored positions, the manually adjusted settings will be applied.

Resetting the System

Take the following procedures to reset integrated memory system, when it does not operate properly.

Resetting integrated memory system

1. Stop the vehicle and open the driver's door with the Start/Stop button in the ON position and the vehicle shifted to P (Park).
2. Adjust the driver's seat and seatback to the foremost position.
3. Press the memory button 1 (or 2) and push forward the driver's seat movement switch over 2 seconds simultaneously.

While resetting integrated memory system

1. Resetting starts with a notification sound.
2. The driver's seat and seatback is adjusted to the rearward position with the notification sound.
3. The driver's seat and seatback is re-adjusted to the default position (central position) with the notification sound.

However, in the following cases, the resetting procedure and the notification sound may stop.

- The memory button is pressed.
- The seat control switch is operated.
- The gear is shifted out of P (Park).
- The driving speed exceeds 3 km/h (2 mph).
- The driver's door is closed.

NOTICE

- **While integrated memory system is being reset, if the resetting and notification sound stops incompletely, restart the resetting procedure again.**
- **Make sure that there is no objects around the driver's seat in advance of resetting the integrated memory system.**
- **After resetting the integrated memory system, the adjustment for the driver seat must be stored again to recall the memory position.**

Seat Easy Access

Seat easy access will move the driver's seat and steering wheel automatically as follows:

- Exiting the vehicle:
The driver's seat will move as follows when the Start/Stop button is in the OFF position with the gear in P (Park) and the driver's door open.
 - Driver seat: Moves rearward depending on the distance selected from the Settings menu in the infotainment system.However, the driver's seat may not move rearward if there is not enough space between the driver's seat and the rear seats.
- Entering the vehicle:
The driver's seat will move as follows when the Start/Stop button is pressed to the ACC, ON or START position or while carrying the smart key, the driver's door is closed with the Start/Stop button in the OFF position.
 - Driver seat: Moves back to its original position.
- You can set the Seat Easy Access function from the Settings menu in the infotainment system screen. Select:
 - Driver seat
Setup → Vehicle Settings → Seat → Seating Easy Access → Driver Seat Easy Access → Normal/Extended/Off

For detailed information, refer to the separately supplied infotainment system manual.

MEMORY SEAT CONFIGURATIONS (IF EQUIPPED)

Memory seat configurations for the seats are provided to store and recall the following memory settings with a simple operation on the infotainment system.

WARNING

Never attempt to operate the integrated memory system while the vehicle is moving.

This could result in loss of control, and an accident causing death, serious injury, or property damage.

CAUTION

The function requires a large amount of electrical power. To prevent the battery from discharging, refrain from using it when the vehicle start switch is off.

- If the battery is disconnected, the memory settings will be erased.
- If integrated memory system does not operate normally, have the system inspected by an authorized HYUNDAI dealer.

Storing Memory Positions

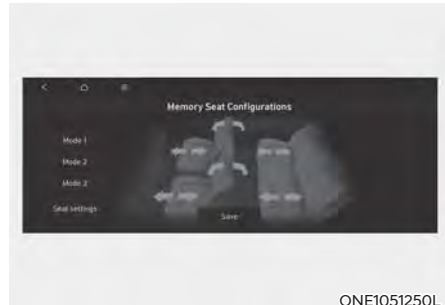

You can save the position of each seat on the Infotainment system screen as below.

1. Shift to P (Park) while the Start/Stop button is in the ON position.
2. Touch the Memory seat configuration icon in the infotainment home screen.
3. Adjust the each seat position with arrow icons to the desired position on the infotainment screen.
4. To save the each seat that desired position, touch the 'Save' icon.
5. Select the one of the mode on the infotainment screen. The mode that selected will be saved.

Recalling Memory Positions

1. Shift to P (Park) while the Start/Stop button is in the ON position.
2. Touch the desired memory mode icon (1,2 or 3) and touch 'Apply' icon on the infotainment screen.
3. The seats will automatically adjust to the stored positions.
4. To stop working while recalling the saved mode, touch 'Stop' icon on the infotainment screen.

STEERING WHEEL

Motor Driven Power Steering (MDPS)

The system assists you with steering the vehicle. If the vehicle is turned off or if the power steering system becomes inoperative, you may still steer the vehicle, but it will require increased steering effort.

Should you notice any change in the effort required to steer during normal vehicle operation, have the system checked by an authorized HYUNDAI dealer.



CAUTION

If Motor Driven Power Steering does not operate normally, the  warning light and the message 'Check motor driven power steering' will illuminate on the instrument cluster. You may steer the vehicle, but it will require increased steering efforts. Take the vehicle to an authorized HYUNDAI dealer and have the system checked as soon as possible.

Information

The following symptoms may occur during normal vehicle operation:

- **The steering effort may be high immediately after pressing the Start/Stop button to the ON position.**
This happens as the system performs the MDPS system diagnostics. When the diagnostics are completed, the steering wheel effort will return to its normal condition.
- **When the battery voltage is low, you might have to put more steering effort. However, it is a temporary condition so that it will return to normal condition after charging the battery.**
- **A click noise may be heard from the MDPS relay after the Start/Stop button is in the ON or OFF position.**
- **Motor noise may be heard when the vehicle is at a stop or at a low driving speed.**
- **When you operate the steering wheel in low temperatures, abnormal noise may occur. If the temperature rises, the noise will disappear. This is a normal condition.**
- **When an error is detected from MDPS, the steering effort assist function will not be activated in order to prevent fatal accidents. Instrument cluster warning lights may be on or the steering effort may be high. If these symptoms occur, drive the vehicle to a safe area as soon as it is safe to do so. Have the system checked by an authorized HYUNDAI dealer as soon as possible.**

Tilt/Telescopic Steering

When adjusting the steering wheel to a comfortable position, adjust the steering wheel so that it points toward your chest, not toward your face. Make sure you can see the instrument cluster warning lights and gauges. After adjusting, push the steering wheel both up and down to be certain it is locked in position.

Always adjust the position of the steering wheel before driving.



WARNING

NEVER adjust the steering wheel while driving. This may cause loss of vehicle control resulting in an accident.

NOTICE

While adjusting the steering wheel height, please do not push or pull it hard since the fixture can be damaged.

Manual adjustment

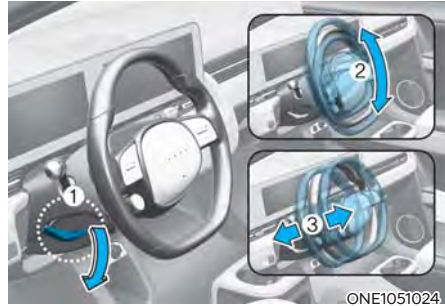

To adjust the steering wheel angle and height:

1. Pull down the lock-release lever (1).
2. Adjust the steering wheel to the desired angle (2) and distance forward/back (3).
3. Pull up the lock-release lever to lock the steering wheel in place.



Information

Sometimes the lock release lever may not engage completely. This may occur when the gears of the locking mechanism do not completely mesh. If this occurs, pull down on the lock-release lever, readjust the steering wheel again, and then pull back up on the release lever to lock the steering wheel in place.

Horn



To sound the horn, press the area indicated by the horn symbol on your steering wheel (see illustration). The horn will operate only when this area is pressed.

NOTICE

Do not strike the horn severely to operate it, or hit it with your fist. Do not press on the horn with a sharp-pointed object.

Heated Steering Wheel (if equipped)

■ Infotainment system

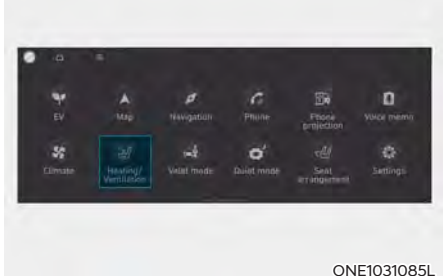

While the vehicle is running, touch Heating/Ventilation icon in the infotainment home screen.

■ Climate control panel

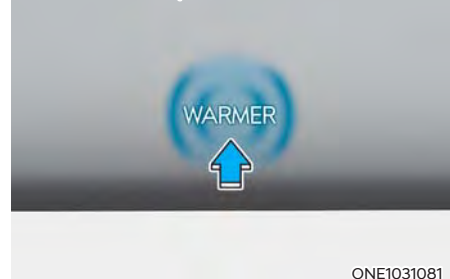

Press WARMER in the front climate control panel



NOTICE

Do not install any cover or accessory on the steering wheel. The cover or accessory could cause damage to the heated steering wheel system.

While the vehicle is running, touch the heated steering wheel icon to warm the steering wheel.

- To warm the steering wheel, touch the heated steering wheel icon in the Heating/Ventilation seats.
- Auto. Controls That Use Climate Control Settings (for driver's seat)

The heated steering wheel automatically controls the steering wheel temperature depending on the ambient temperature when the vehicle is running.

To use this function, it must be enabled from the Settings menu in the infotainment system screen.

Select:

- Setup → Vehicle Settings → Seat → Heated/Ventilated Features → Auto. Controls That Use Climate Control Settings → Heated steering wheel

For detailed information, refer to the separately supplied infotainment system manual.

- The heated steering wheel defaults to the OFF position whenever the Start/Stop button is pressed to the ON position. However, if the Auto. Controls That Use Climate Control Settings function is ON, the heated steering wheel will turn on and off depending on the outside temperature.

MIRRORS

Inside Rearview Mirror

Before driving your vehicle, check to see that your inside rearview mirror is properly positioned. Adjust the rearview mirror so that the view through the rear window is properly centered.



WARNING

Make sure your line of sight is not obstructed. Do not place objects in the rear seat, cargo area, or behind the rear head restraints which could interfere with your vision through the rear window.



WARNING

To prevent serious injury during an accident or deployment of the air bag, do not modify the rearview mirror and do not install a wide mirror.



WARNING

NEVER adjust the mirror while driving. This may cause loss of vehicle control resulting in an accident.

NOTICE

When cleaning the mirror, use a paper towel or similar material dampened with glass cleaner. Do not spray glass cleaner directly on the mirror as this may cause the liquid cleaner to enter the mirror housing.

Day/night rearview mirror (if equipped)

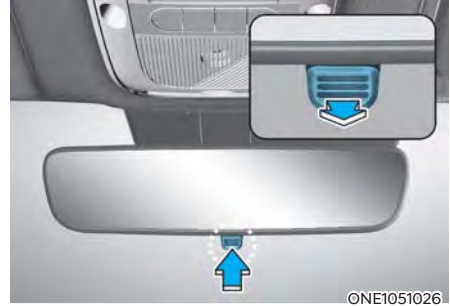

Make this adjustment before you start driving and while the day/night lever is in the day position.

Pull the day/night lever towards you to reduce glare from the headlights of the vehicles behind you during night driving.

Remember that you lose some rearview clarity in the night position.

**Electric Chromic Mirror (ECM)
(if equipped)**



[A] : Indicator

Some vehicles come equipped with an electrochromic mirror that helps control glare while driving at night or under low light driving conditions.

When the vehicle is running, the glare is automatically controlled by the sensor mounted in the rearview mirror. The sensor detects the light level around the vehicle, and automatically adjusts to control the headlight glare from vehicles behind you.

Whenever the the gear is shifted to R (Reverse), the mirror will automatically go to the brightest setting in order to improve the driver's view behind the vehicle.

**Electrochromic mirror (ECM) with
HomeLink® system (if equipped)**

Your vehicle may be equipped with a Gentex Automatic-Dimming Mirror with an Integrated HomeLink® Wireless Control System.

During nighttime driving, this feature will automatically detect and reduce rearview mirror glare. The HomeLink® Universal Transceiver allows you to activate your garage door(s), electric gate, home lighting, etc.

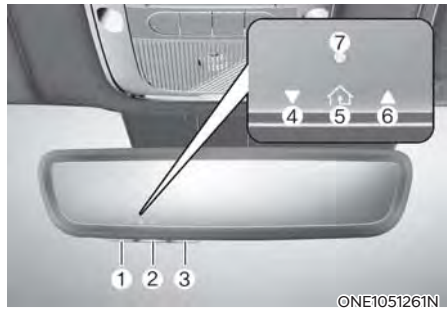

- (1) HomeLink Channel 1
- (2) HomeLink Channel 2
- (3) HomeLink Channel 3
- (4) Garage Door Opener Status Indicator :
Closing or Closed
- (5) HomeLink Operation Indicator
- (6) Garage Door Opener Status Indicator :
Opening or Opened
- (7) HomeLink User Interface Indicator

Automatic-Dimming Night Vision Safety™ (NVS®) Mirror (if equipped)

The NVS® Mirror automatically reduces glare by monitoring light levels in the front and the rear of the vehicle. Any object that obstructs either light sensor will degrade the automatic dimming control feature.

For more information regarding NVS® mirrors and other applications, please refer to the Gentex website:

www.gentex.com

Your mirror will automatically dim upon detecting glare from the vehicles traveling behind you.

The mirror defaults to the ON position each time the vehicle is started.

Integrated HomeLink® Wireless Control System

The HomeLink® Wireless Control System provides a convenient way to replace up to three hand held radio-frequency transmitters used to activate compatible devices such as gate operators, garage door openers, entry door locks, security systems, and home lighting.

NOTICE

HomeLink® operates while the ignition switch is in the ACC or ON position for safety reasons. It is to prevent unintentional security problems from happening when the vehicle is parked outside the garage.



WARNING

Before programming HomeLink® to a garage door opener or gate operator, make sure people and objects are out of the way of the device to prevent potential harm or damage. Do not use the HomeLink® with any garage door opener that lacks the safety stop and reverse features required by U.S. federal safety standards (this includes any garage door opener model manufactured before April 1, 1982). A garage door that cannot detect an object - signaling the door to stop and reverse - does not meet current U.S. federal safety standards. Using a garage door opener without these features increases the risk of serious injury or death.

For more information, contact HomeLink® at www.homelink.com, or call Home-Link customer support at 1-800-355-3515.

It is also recommended that a new battery be replaced in the handheld transmitter of the device being trained to HomeLink® for quicker training and accurate transmission of the radio frequency.

1. Programming HomeLink®

The following steps show how to program HomeLink. If you have any questions or are having difficulty programming your HomeLink buttons, refer to the HomeLink website or call the HomeLink customer support toll-free number. Do this, before going back to the dealer who sold you the car.

- Visit the HomeLink website at: **www.homelink.com**. Then at the top of the page, choose your vehicle make. Then watch the YouTube video, and/or access additional website information.
- If you choose to access the website via your cell phone, scan the QR code.



- Or, call HomeLink customer support at **1-800-355-3515** (Please have the vehicle make/model AND the opener device make/model readily available.)

1) Programming Preparation



1. When programming a garage door opener, it is advised to park the vehicle outside of the garage.
2. It is recommended that a new battery be placed in the handheld transmitter of the device being programmed to HomeLink for quicker training and accurate transmission of the radio-frequency signal.
3. Place the ignition switch to the ACC (Accessory) position for programming of HomeLink.

2) Programming a New HomeLink®



1. Press and release the HomeLink button (1), (2) or (3), you would like to program. The HomeLink indicator light (7) will flash orange slowly (if not, perform the steps of “Erasing HomeLink Buttons” section, and start over).



2. Position the garage door opener remote 1 – 3 inches (2 – 8cm) away from the HomeLink buttons.
3. While the HomeLink indicator light (7) is flashing orange, press and hold the hand-held remote button. Continue pressing the handheld remote button until the HomeLink indicator light (7) light changes from orange to green. You may now release the handheld remote button.
4. Wait until your garage door comes to a complete stop, regardless of position, before proceeding to the next steps.
5. Press and release the HomeLink button you are programming and observe the indicator light.
 - If the indicator light remains solid green, your device should operate when the HomeLink button is pressed. At this point, if your device operates, programming is complete.
 - If the indicator light rapidly flashes green, firmly press, hold for two seconds and release the HomeLink button up to three times in a row slowly to complete the programming process. Do not press the HomeLink button rapidly. At this point if your device operates, programming is complete. If the device does not operate, continue with step 6.

6. At the garage door opener motor, (security gate motor, etc.) locate the “Learn”, “Smart”, “Set” or “Program” button. This can usually be found where the hanging antenna wire is attached to the motor-head unit (see the device’s manual to identify this button). The name and color of the button may vary by manufacturer.

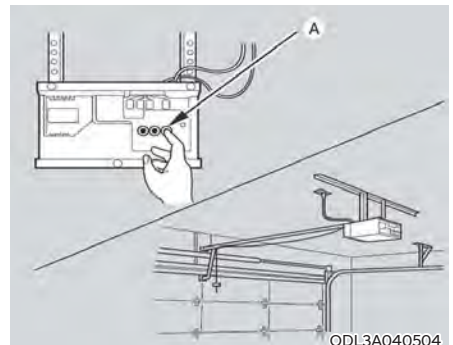

- * A ladder and/or second person may simplify the following steps.
7. Firmly press and release the “Learn”, “Smart”, “Set” or “Program” button. You now have up to 30 seconds in which to complete the next step.
 8. Return to the vehicle and firmly press, hold for two seconds and release, the HomeLink button up to three times in a row slowly. Do not press the HomeLink button rapidly. As soon as you see the garage door start to move, stop pressing any buttons until a few seconds after the garage door has come to a complete stop, regardless of position. At this point, programming is complete and your device should operate when the HomeLink button is pressed and released.

3) Two-Way Communication Programming (For select garage door openers)

If your garage door opener has the 'myQ' logo on its side, your opener likely has Two-Way Communication capability. HomeLink has the capability to establish Two-Way Communication with your garage door opener. HomeLink can receive and display "closing" or "opening" status messages from compatible garage door openers. At any time, Home-Link can also recall and display the last recorded status communicated by the garage door opener to indicate your garage door being "closed" or "opened".

To check if your garage door opener is compatible with this feature, refer to www.homelink.com/compatible/Two-way-Communication. If your garage door opener has this functionality, AND the Two-Way Communication indicators (4), (6) in the mirror appear while the garage door is opening/closing, then no further steps are needed. Two-Way Communication Programming is already complete. However, if your garage door opener has this functionality, AND the Two-Way Communication indicators (4), (6) in the mirror DO NOT appear while the garage door is opening/closing, use the following instructions to enable this functionality.

1. In your vehicle, press and hold the programmed HomeLink button for 2 seconds, then release. Confirm that the garage door is moving. AFTER it stops, you will have one minute to complete the following steps:
 - * A ladder and/or second person may simplify the following steps.

2. On your garage door opener in your garage, locate the "Learn" button (usually near where the hanging antenna wire is attached to the garage door opener). If there is difficulty locating this button, reference the device's owner's manual.
3. Press and release the "Learn" button.
4. A light on your garage door opener may flash, and your Two-Way Communication indicators (4), (6) in your vehicle may flash, confirming completion of the process.
5. Return to the vehicle and firmly press and release the programmed HomeLink button to activate your garage door. The Two-Way Communication indicators (4), (6) flash in orange when the door is moving. Do not make any additional button presses until AFTER the garage door has come to a complete stop.
6. Your Two-Way Communication programming is now complete.

Information

If your garage door opener has Two-Way Communication functionality, it is possible for HomeLink to stop functioning the garage door shortly after initial programming, IF the Two-Way Communication Programming wasn't properly completed. This usually happens after the first 10 times a programmed HomeLink button is pressed. If you experience this, completing the "Programming a New HomeLink Button" and "Two-Way Communication Programming" will restore door operation.

4) Canadian Programming

Canadian radio-frequency laws require transmitter remote signals to “time-out” (or quit) after a couple seconds of transmission, which may not be long enough for HomeLink to pick up the signal during programming.

If you live in Canada or you are having difficulties programming a gate operator or garage door opener by using the programming procedures, replace “Programming a New HomeLink Button” step 3 with the following:

While the HomeLink indicator light (7) is flashing orange, press and release (“cycle”) your device’s handheld remote every two seconds until the HomeLink indicator light (7) changes from orange to green. You may now release the handheld remote button. Then proceed with “Programming a New HomeLink Button” step 4.

2. Operating HomeLink®

1) Operating HomeLink®



1. Press and release the desired programmed HomeLink button (1, 2 or 3).

i Information

The HomeLink indicator (7) should light green, solid or flashing, and your programmed device should operate.

If your device does not operate, the HomeLink programming was not successful, and you’ll need to reprogram the button.

2) Two-Way Communication Display Behavior



1. Press and release one of the programmed HomeLink buttons (1, 2 or 3).



2. The indicator (4) and (6) operates as below, if your garage door opener has Two-Way Communication functionality.

- If the indicator (4) flashes in Orange, it indicates that the garage door is “Closing”.
- The indicator (4) turns solid green once the garage door has closed.
- If the indicator (6) flashes in Orange, it indicates that the garage door is “Opening”.
- The indicator (6) turns solid green once the garage door has fully opened.
- If the indicator (4) or (6) does not turn to green, it indicates that the last status of garage door was not received properly. The HomeLink mirror tries to receive the last known status of the garage door for a few seconds.

3) Recalling Garage Door Status

HomeLink mirror with Two-Way Communication provides a way to view the last stored message from the garage door opener. In order to recall the last known status of the last activated device, press the buttons “1 and 2” OR “2 and 3” simultaneously.

- If the indicator (4) appears solid Green, it indicates that the last activated device was “closed” properly.
- If the indicator (6) appears solid Green, it indicates that the last activated device was “open” properly.

3. Erasing HomeLink® Buttons

1) Erasing and Reprogramming a Single HomeLink® Button:

1. Press and hold the desired HomeLink button you want to re-program. DO NOT release the button.
2. The HomeLink indicator light (7) will illuminate solid green. Release the button as soon as the HomeLink indicator light (7) begins to flash orange, usually about 20 seconds.
3. Proceed with the steps in the “Programming a New HomeLink Button” section.



Information

If you do not complete the re-programming of a new device to the button, it will revert to the previously stored programming.

2) The following instructions will erase ALL HomeLink® programming from ALL buttons:



1. Press and hold the buttons (1) and (3) simultaneously
2. The HomeLink indicator light (7) will illuminate solid Orange for about 10 seconds
3. Release the buttons once the HomeLink indicator light (7) changes to Green and flashes rapidly
4. Now all three HomeLink buttons (1), (2) and (3) are cleared of any programming



Information

HomeLink® and the HomeLink® House logo are registered trademarks of Gentex Corporation.

The myQ logo is a registered trademark of The Chamberlain Group, Inc.

FCC (USA) and ISED (Canada)

This device complies with FCC rules part 15 and Innovation, Science, and Economic Development Canada RSS-210. Operation is subject to the following two conditions: (1) This device may not cause harmful interference, and (2) This device must accept any interference that may be received including interference that may cause undesired operation. **WARNING:** The transmitter has been tested and complies with FCC and ISED rules. Changes or modifications not expressly approved by the party responsible for compliance could void the user's authority to operate the device.

This equipment complies with FCC and ISED radiation exposure limits set forth for an uncontrolled environment. End Users must follow the specific operating instructions for satisfying RF exposure compliance. This transmitter must be at least 20cm from the user and must not be co-located or operating in conjunction with any other antenna or transmitter.

Cet appareil est conforme aux règlements de la FCC, section 15, et au CNR-210 d'Innovation, Sciences et Développement économique Canada. Le fonctionnement est assujéti aux deux conditions suivantes : (1) cet appareil ne doit pas causer d'interférences nuisibles et (2) cet appareil doit accepter toute interférence reçue, y compris celle qui pourrait entraîner un dysfonctionnement. **MISE EN GARDE :** L'émetteur a subi des tests et est conforme aux règlements de la FCC et d'ISDE. Les changements ou modifications non approuvés explicitement par la partie responsable de la conformité pourraient rendre caduque l'autorisation de l'utilisateur de se servir du dispositif.

Cet appareil est conforme aux limites d'exposition aux radiations de la FCC et d'ISDE établies pour un environnement non contrôlé. Les utilisateurs finaux doivent respecter les instructions d'utilisation spécifiques pour satisfaire aux exigences de conformité aux expositions de RF. L'émetteur doit se trouver à 20 cm au minimum de l'utilisateur et ne doit pas être situé au même endroit que tout autre émetteur ou antenne ni fonctionner avec un autre émetteur ou antenne.

HomeLink 5 Programming Flow Chart

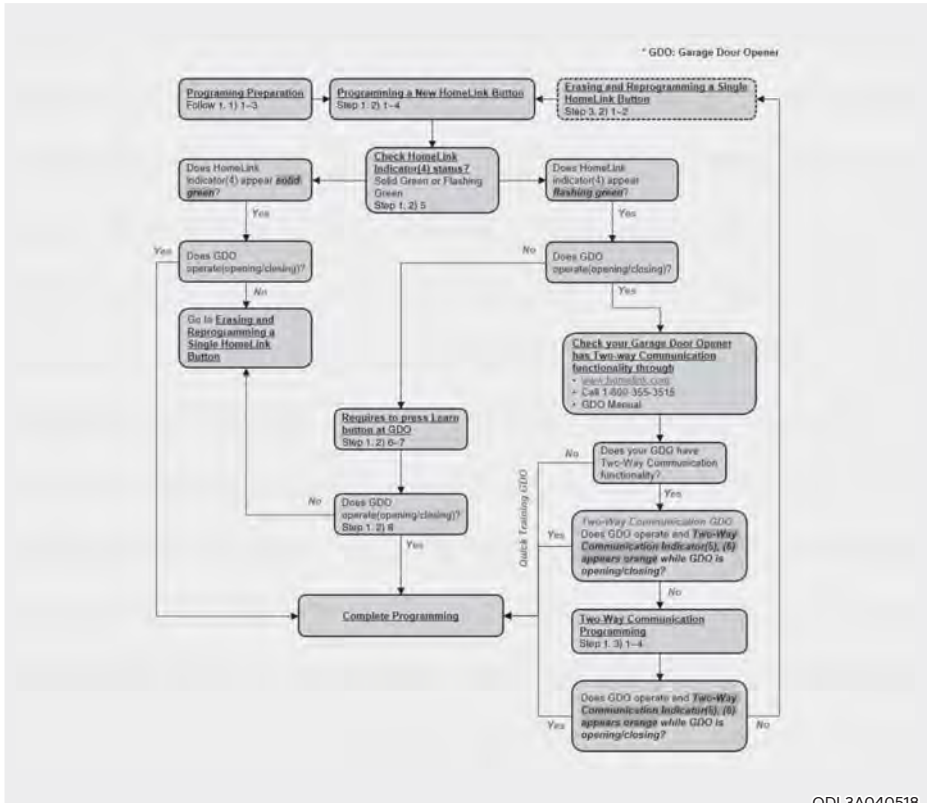

Side View Mirrors



Your vehicle is equipped with both left-hand and right-hand sideview mirrors. The mirrors can be adjusted remotely with the mirror adjustment control switch. The sideview mirrors can be folded to help prevent damage when going through an automatic car wash or when passing through a narrow street.

The right sideview mirror is convex. Objects seen in the mirror are closer than they appear.

Use the inside side view mirror or look back directly to determine the actual distance of other vehicles prior to changing lanes.

Make sure to adjust the sideview mirrors to your desired position before you begin driving.



WARNING

Do not adjust or fold the sideview mirrors while driving. This may cause loss of vehicle control resulting in an accident.

NOTICE

- Do not scrape ice off the mirror face; this may damage the surface of the glass.
- If the mirror is jammed with ice, do not adjust the mirror by force. Use an approved de-icer (not radiator antifreeze) spray, or a sponge or soft cloth with very warm water, or move the vehicle to a warm place and allow the ice to melt.
- Do not clean the mirror with harsh abrasives, fuel or other petroleum based cleaning products.

Adjusting the rearview mirrors



Adjusting the rearview mirrors:

1. When the START/STOP button is in the ACC, ON or START position, press either the L (Left side) or R (Right side) button (1) to select the rearview mirror you would like to adjust.
2. Use the mirror adjustment control switch (2) to position the selected mirror up, down, left or right.
3. After adjustment, move the lever (1) to the middle to prevent inadvertent adjustment.

NOTICE

- **The mirrors stop moving when they reach the maximum adjusting angles, but the motor continues to operate while the switch is pressed. Do not press the switch longer than necessary, because this can damage the motor.**
- **Do not attempt to adjust the rearview mirrors by hand, because this can damage the motor.**

Folding the rearview mirrors



Folding button

The rearview mirrors can be folded or unfolded by pressing the button.

Infotainment system setting

- Enable on door unlock
 - If 'Setup → Vehicle Settings → Welcome Mirror → Enable on Door Unlock' is selected from the Settings menu in the infotainment system screen,
 - The mirror will fold or unfold when the door is locked or unlocked by the smart key.
 - The mirror will fold or unfold when the door is locked or unlocked by the touch sensor or button on the outside door handle.
- Enable on driver approach
 - If 'Setup → Vehicle Settings → Convenience → Welcome Mirror → Enable on Driver Approach' is selected from the Settings menu in the infotainment system screen, the mirror will unfold when the vehicle is approached with the smart key in possession.

For detailed information, refer to the separately supplied infotainment system manual.

i Information

For your safety, the side view mirrors cannot be folded automatically when driving at a speed of 9 mph (15 km/h) or faster.

NOTICE

The electric type side view mirror operates even though the Start/Stop button is in the OFF position. However, to prevent unnecessary battery discharge, do not adjust the mirrors longer than necessary while the vehicle is not running.

NOTICE

Do not fold the electric type side view mirror by hand. It could cause motor failure.

Reverse Parking Aid (if equipped)



When the gear is shifted to the R (Reverse) position, the side view lever(s) will rotate downwards to aid with driving in reverse.

The state of the side view mirror lever (1) determines whether or not the mirrors will move:

How it works

- Left/Right : When either the L (Left) or R (Right) lever is selected, both side view mirrors will move.
- Neutral : When neither switch is selected, the side view mirrors will not move.

The side view mirrors will automatically revert to their original positions if any of the following occur:

- The Start/Stop button is pressed to either the OFF position or the ACC position.
- The gear is shifted to any position except R (Reverse).
- The side view mirror adjustment button is not selected.

Reverse parking aid user settings mode

You may change the angle of the side view mirror if it is difficult to see the rear view with the basic downward mirror angle provided when reversing.

When the vehicle is first delivered, the set downward angle of the left and right side view mirror are different to ensure driver visibility.

1. Make sure the vehicle is stopped.
2. Depress the brake pedal and shift the gear to R (Reverse). When L (Left) or R (Right) button is pressed, both side view mirror angle will move downward to the basic set position.
3. Press either L or R button to select the side view mirror you would like to adjust. Then press “▼, ▲, ◀, ▶” switch to adjust the side view mirror to the desired angle.
4. After adjusting the angle to save the adjusted side view mirror angle, shift the gear to another position other than R (Reverse), or change the L and R buttons to the neutral position (L and R buttons are not pressed).
5. Set the other side view mirror following the above procedure 1 to 4.

Resetting reverse parking aid user settings mode

To change the side view mirror angle back to the basic angle, shift the gear to R (Reverse), and adjust the mirror angle higher than when the gear is in P (Park), N (Neutral) and D (Drive).

NOTICE

When changing the angle of both side view mirrors, it is recommended to change the angle one side at a time following the procedure 1 to 4.

DIGITAL CENTER MIRROR (DCM) (IF EQUIPPED)

The Digital Center Mirror is a system that uses the camera on the rear of the vehicle and displays its image on the screen of the Digital Center Mirror. The Digital Center Mirror allows the driver to see the rear view despite obstructions, such as the headrest or luggage, ensuring rear visibility.



WARNING

- Failure to follow the warnings and instructions for proper use of the Digital Center Mirror could result in serious accident.
 - The Digital Center Mirror is a convenience feature but it is not a substitute for proper vehicle operation. The system has areas where objects cannot be viewed. Check the blind spot of the Digital Center Mirror before vehicle operation. The driver is always responsible for safe driving.
 - Do not operate the Digital Center Mirror while driving. Doing so can not be a distraction and it could lose control of your vehicle and cause an accident or serious injury.
 - Do not disassemble or modify the Digital Center Mirror, the camera unit or wirings. If you do, it may result in accidents or fire. In case you notice smoke or smell coming from the Digital Center Mirror, stop using the system immediately. See an authorized HYUNDAI dealer for servicing.
- Be sure to adjust the Digital Center Mirror before driving.
 - Switch the system to the conventional rearview mirror mode and be properly seated on the driver's seat. Then adjust the mirror so as to see the rear window properly.
 - Push the lever all the way to change to digital mirror mode and adjust the display settings. Driving without adjusting the mirror may cause difficulty in watching the display at the Digital Mirror mode (camera view mode) due to the reflection from the surface of the mirror.
 - As the range of the image display by the Digital Center Mirror is different from that of the optical mirror, make sure to check this difference before driving.

- If the Digital Center Mirror malfunctions, immediately switch the system to the conventional rearview mirror mode.
- When strong light (for example, sunlight or high beams from following vehicles) enters the camera, a light beam or a glaring light may appear on the monitor screen of the Digital Center Mirror. In that case, switch the system to the conventional rearview mirror mode appropriately.

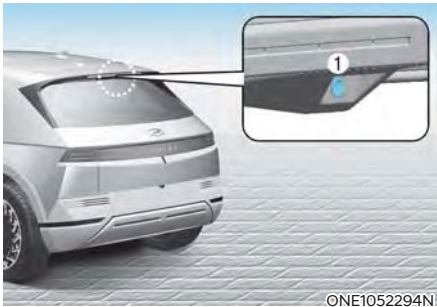

- If the camera lens (1) is dirty, the displayed image may not be clear. In this case, clean it with a soft cloth dampened with water or a swab.

System Component

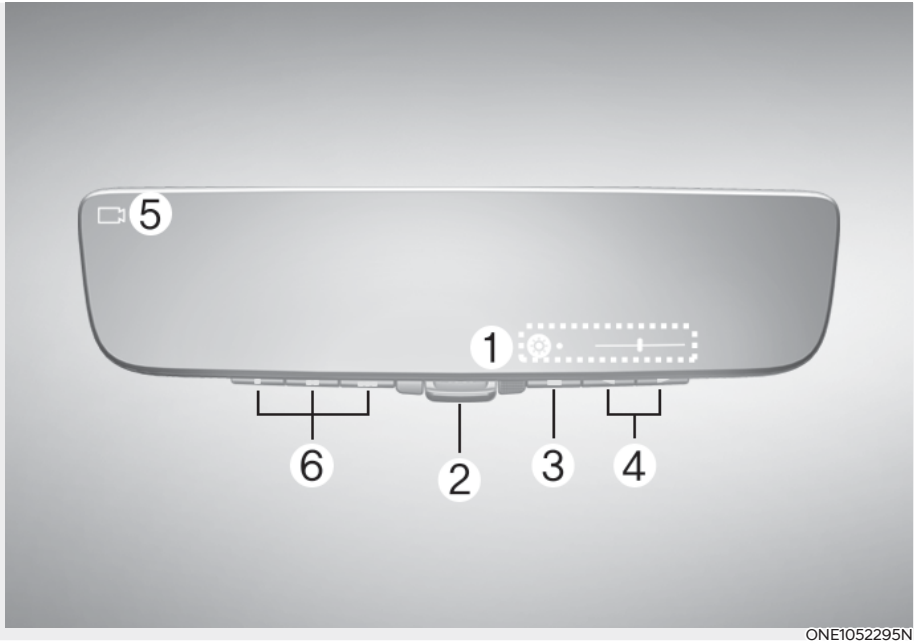

ONE1052295N

1. Icon display area
Displays icons, adjusting Brightness & Tilt
2. Lever
Operate to change between digital mirror mode and optical mirror mode.
3. Menu button
Press to display the icon display area and select the item you want to adjust (Brightness & Tilt).
4. Select/adjust button
Press to change the setting of the item you want to adjust.
5. Camera indicator
Indicates that the camera is operating normally.
6. HomeLink buttons
For the operation of the “HomeLink® Universal Transceiver”.

How To Change the Mode

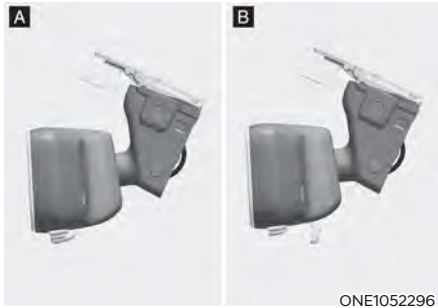

ONE1052296

The mode can be switched when the switch is in the ON position.

1. Pull the mode select lever all the way to switch to the Digital Center Mirror mode (camera view mode).
 - * Displays an image of the area behind the vehicle. In this mode, camera indicator (6) is shown.
2. Push the mode select lever all the way to switch to the optical inside rearview mirror mode
 - * Turns off the display of the Digital Center Mirror allows it to be used as an optical mirror.

Adjusting the mirror height



ONE1052297

The height of the rearview mirror can be adjusted to suit your driving posture.

Change to optical mirror mode, adjusting the rearview mirror angle by moving it up and down.

Display Settings (Digital Mirror Mode)

Settings of the display in the digital mirror mode.

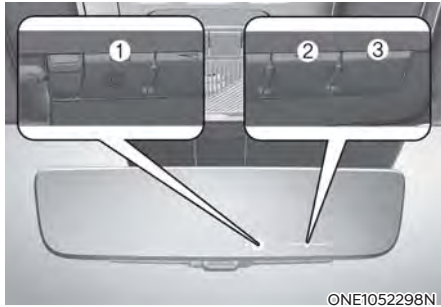

ONE1052298N

1. Press the menu button (a). You can adjust the brightness and the vertical angle of the display.

Icons display	Settings
	Select to adjust the brightness of the display.
	Select to adjust the display.

2. Press the menu button repeatedly and select the item you want to adjust.
3. Press the button (b) or button (c) to change the setting.

The icons will disappear if the button is not operated for approximately 5 seconds or more.

- * If the brightness of the Digital Center Mirror is set too high, it may cause eye strain.

Adjust the Digital Center Mirror to an appropriate brightness. If your eyes become tired, change to optical mirror mode.



ONE1052299N

To prevent the light sensors from malfunctioning

To prevent the light sensors from malfunctioning, do not touch or cover them.

Digital mirror mode operating condition

The START/STOP button is in the ON position.

When the START/STOP button is changed from ON position to OFF or ACC position, the image will be disappeared.

When using the Digital Center Mirror in digital mirror mode

- When the liftgate is open, the Digital Center Mirror image may not display properly. Before driving, make sure the liftgate is closed.
- If the display is difficult to see due to reflected light, close the sunshade for the sunroof (if equipped).
- Any of the following conditions may occur when driving in the dark, such as at night. None of them indicates that the malfunction has occurred.
 - Colors of objects in the displayed image may differ their actual color.
 - Depending on your physical condition or age, it may take longer than usual to focus on the displayed image. In this case, change to optical mirror mode.
 - Do not let passengers stare at the displayed image when the vehicle is being driven, as doing so may cause motion sickness.

When the system malfunctions



If the symbol shown in the illustration is displayed when using the Digital Center Mirror in digital mirror mode, the system may be malfunctioning. The symbol will disappear in a few seconds. Operate the lever, change to optical mirror mode and have the vehicle inspected by an authorized HYUNDAI dealer.





CAUTION

To prevent the Digital Center Mirror from malfunctioning

- **Do not use detergents, such as thinner, benzene, and alcohol to clean the mirror. They may discolor, deteriorate or damage the mirror surface.**
- **Do not remove, disassemble or modify the mirror and camera.**
- **Do not allow an organic solvent, vehicle wax, window cleaner or glass coating to adhere to the camera. If this happens, wipe it off as soon as possible.**

- When cleaning the camera lens, wipe the camera lens with a damp soft cloth.
- Do not strongly rub the camera lens, as it may be scratched and will not be able to transmit a clear image.
- Do not subject the camera to a strong impact as this could cause a malfunction. If this happens, have the vehicle inspected by an authorized HYUNDAI dealer as soon as possible.
- Operating the system at the ON position while the vehicle is not running would cause discharging of the battery.
- Do not attach an antenna of wireless device near the Digital Center Mirror. Electric wave from wireless device may cause disturbed image in Digital Center Mirror.
- Do not push buttons excessively or operating the lever roughly may cause a system failure or the Digital Center Mirror itself to drop.
- Never rotate the body of Digital Center Mirror by 90° or more. It may damage the Digital Center Mirror. Do not apply strong shocks to the body of Digital Center Mirror. It may cause a system failure.
- If it is difficult to see the Digital Center Mirror display screen because of a strong external light, switch the mode to the conventional rearview mirror mode for better use.

Digital Center Mirror error icon and solution

Symptom	Likely cause	Solution
<p>If the high temp icon is displayed on the display right side.</p> 	<p>The Digital Center Mirror is extremely hot. (The display will gradually become more dim. If the temperature continues to increase, the Digital Center Mirror will turn off.)</p>	<p>Reducing the cabin temperature is recommended to reduce the temperature of the mirror. (The icon will disappear when the mirror becomes cool.) If the icon does not disappear even though the mirror is cool, have the vehicle inspected by an authorized HYUNDAI dealer.</p>
<p>If the display icon  has been switched to  which is the display error icon.</p>	<p>The system may be malfunctioning.</p>	<p>Change to optical mirror mode and have the vehicle inspected by an authorized HYUNDAI dealer.</p>

WINDOWS

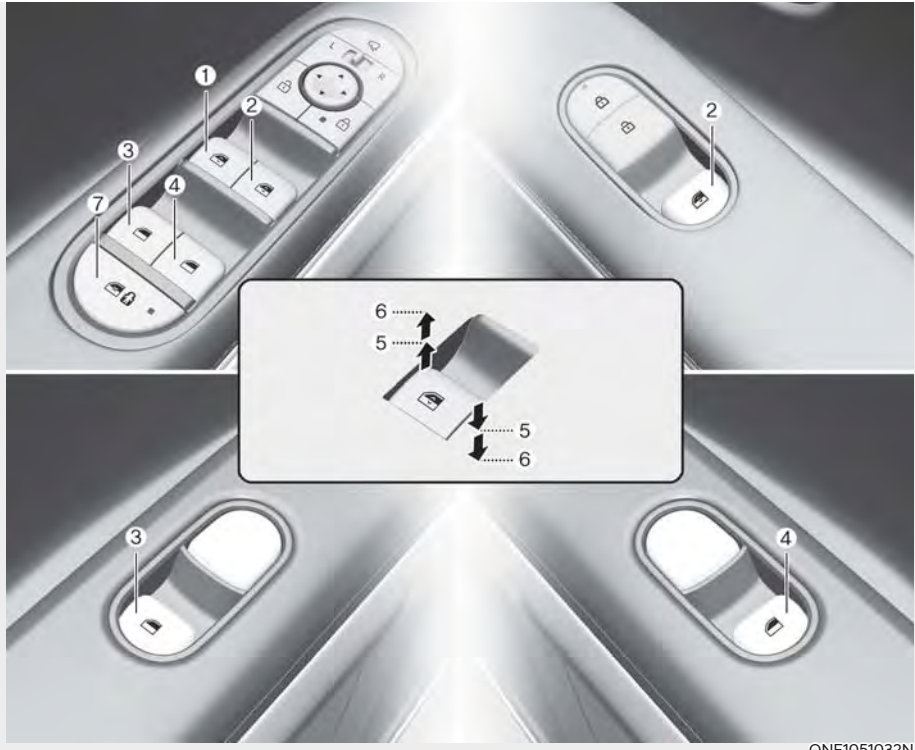

ONE1051032N

- (1) Driver's door power window switch
- (2) Front passenger's door power window switch
- (3) Rear door (left) power window switch
- (4) Rear door (right) power window switch
- (5) Window opening and closing
- (6) Automatic power window
- (7) Power window lock switch

Power Windows

The Start/Stop button must be in the ON position to be able to raise or lower the windows. Each door has a Power Window switch to control that door's window. The driver has a Power Window Lock button which can block the operation of rear passenger windows. The power windows will operate for approximately 3 minutes after the Start/Stop button is in the ACC or OFF position. However, if the front doors are opened, the Power Windows will not operate even within the 3 minute period.

Window opening and closing

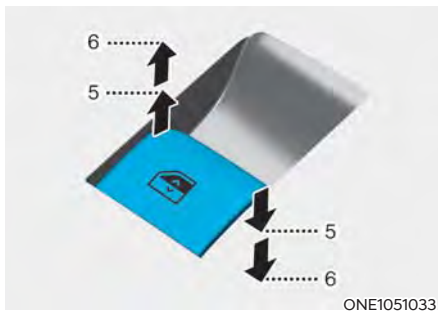

To open:

Press the window switch down to the first detent position (5). Release the switch when you want the window to stop.

To close:

Pull the window switch up to the first detent position (5). Release the window switch when you want the window to stop.

Auto up/down window

Pressing the power window switch momentarily to the second detent position (6) completely lowers or lifts the window even when the switch is released. To stop the window at the desired position while the window is in operation, pull up or press down and release the switch.

WARNING

- Do not leave the vehicle running and the key in your vehicle with unsupervised children. Unattended children could operate the window, which could result in serious injury.
- Do not extend your head, arms or any other body parts or objects outside the window while driving to avoid serious injury.

Resetting the power windows

If the power windows do not operate normally, the automatic power window system must be reset as follows:

1. Press the Start/Stop button to the ON position.
2. Close the window and continue pulling up on the power window switch for at least one second.

If the power windows do not operate properly after resetting, have the system inspected by an authorized HYUNDAI dealer.

WARNING

The automatic reverse feature doesn't activate while resetting the power window system. Make sure body parts or other objects are safely out of the way before closing the windows to avoid injuries or vehicle damage.

Automatic reverse

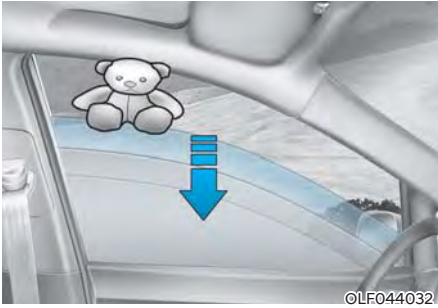

If a window senses any obstacle while it is closing automatically, it will stop and lower approximately 12 in. (30 cm) to allow the object to be cleared.

If the window detects the resistance while the power window switch is pulled up continuously, the window will stop upward movement then lower approximately 1 in. (2.5 cm).

If the power window switch is pulled up continuously again within 5 seconds after the window is lowered by the automatic window reverse feature, the automatic window reverse will not operate.

Information

The automatic reverse feature is only active when the “Auto Up” feature is used by fully pulling up the switch to the second detent.

WARNING

Make sure body parts or other objects are safely out of the way before closing the windows to avoid injuries or vehicle damage.

Objects less than 0.16 in. (4 mm) in diameter caught between the window glass and the upper window channel may not be detected by the automatic reverse window and the window will not stop and reverse direction.

Power window lock button



The driver can disable the power window switches on the rear passenger doors by pressing the power window lock button. When the power window lock button is pressed:

- The rear passenger control will not be able to operate the rear passenger power window.
- Note that the front passenger control is still able to operate the front passenger window, and that the driver master control can still operate all the power windows.

WARNING

Do not allow children to play with the power windows. Keep the driver's door power window lock button in the LOCK position. Serious injury or death can result from unintentional window operation by a child.

NOTICE

- To prevent possible damage to the power window system, do not open or close two windows or more at the same time. This will also ensure the longevity of the fuse.
- Never try to operate the main switch on the driver's door and the individual door window switch in opposite directions at the same time. If this is done, the window will stop and cannot be opened or closed.

Remote window opening/closing function (if equipped)



You can still control the window movement with the vehicle turned off by pressing the Door Lock button (1) or the Door Unlock button (2).

- Press the door lock button for more than 3 seconds. The doors will lock and the windows will move up as long as you press the door lock button.
- Press the door unlock button for more than 3 seconds. The doors will unlock and the windows will move down as long as you press the door unlock button.

i Information

- The remote window opening/closing function will be operated only with the Safety Power Windows equipped.
- The remote window opening/closing function may abruptly stop when you move away from your vehicle during operation. Stay in close proximity from your vehicle, while monitoring the window movement.
- One of the windows may stop operating when the window is interrupted by certain force. However, the other windows will keep operating. Make sure that all windows are closed.
- Please be aware that the doors unlock when the windows are opened using the remote window open/closing function.

! WARNING

Always double check to make sure arms, hands, head and other obstructions are safely out of the way before using remote window closing function.

VISION ROOF (IF EQUIPPED)

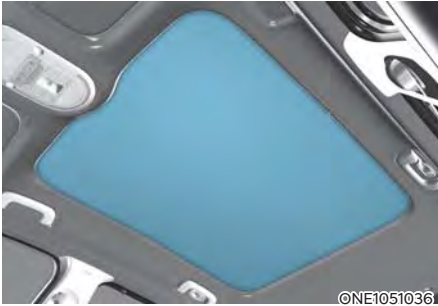

If your vehicle is equipped with a vision roof, you can slide open the power sunshade and an all-glass roof appears.

Power sunshade

Use the power sunshade to block direct sunlight coming through the vision roof glass.



The power sunshade can only be operated when Start/Stop button is in the ON or START position.

- Push the switch rearward, the power sunshade automatically slides open.
- Push the vision roof switch forward, the power sunshade automatically closes.

To stop the power sunshade at any point, push the switch in any direction.

i Information

- The power sunshade can be operated for approximately 3 minutes after the Start/Stop button is in the ACC or OFF position. However, if the front door is open, the power sunshade cannot be operated even within the 3 minute period.
- Wrinkles formed on the power sunshade are normal due to material characteristic.

! WARNING

- Adjust the power sunshade when your vehicle stops. This could result in loss of control and an accident that may cause injury, or property damage.
- Do not leave the vehicle running and the key in your vehicle with unsupervised children. Unattended children could operate the power sunshade, which could result in injury.
- Do not sit on the top of the vehicle. It may cause injury or vehicle damage.

NOTICE

Do not pull or push the power sunshade by hand as such action may damage the power sunshade or cause it to malfunction.

Automatic reversal



If the power sunshade senses any obstacle while it is closing automatically, it will reverse direction then stop at a certain position.

The auto reverse function may not work if an object thin or soft is caught between the sliding power sunshade and vision roof sash.

WARNING

- Make sure heads, hands, arms or any other body parts or objects are out of the way before operating the power sunshade . Body parts or objects may get caught causing injuries or vehicle damage.
- Never deliberately use your body parts to test the automatic reversal function. The power sunshade may reverse direction, but there is a risk of injury.

NOTICE

Do not continue to push the switch after the power sunshade is fully opened or closed. Damage to the power sunshade motor could occur.

Resetting the Vision Roof



In some circumstances resetting the power sunshade operation may need to be performed. Some instances where resetting the power sunshade may be required include:

- When the 12-volt battery is either disconnected or discharged
- When the power sunshade fuse is replaced
- If the power sunshade one-touch AUTO OPEN/CLOSE operation is not functioning properly

Vision roof resetting procedure:

1. It is recommended to perform the reset procedure with the vehicle in the ready mode. Start the vehicle in P (Park).
2. Make sure the power sunshade is in the fully closed position. If the power sunshade is open, push the switch forward until the power sunshade and is fully closed.
3. Release the switch when the power sunshade is fully closed.
4. Push the switch forward until the power sunshade moves slightly. Then release the switch.
5. Once again push and hold the switch forward until the power sunshade slides open and close. Do not release the switch until the operation is completed.

If you release the switch during operation, start the procedure again from step 2.

Information

If the power sunshade is not reset when the vehicle battery is disconnected or discharged, or the power sunshade fuse is blown, the power sunshade may not operate normally.

EXTERIOR FEATURES

Hood

Opening the hood



1. Park the vehicle and set the parking brake.
2. Pull the release lever to unlatch the hood. The hood should pop open slightly.



3. Go to the front of the vehicle, raise the hood slightly, push to the left the secondary latch (1) inside of the hood center and lift the hood (2).

Closing the hood

1. Before closing the hood, check in and around the motor compartment to ensure the following:
 - Any tools or other loose objects are removed from the motor room area or hood opening area
 - All glove, rags, or other combustible material is removed from the motor compartment
 - All filler caps are tightly and correctly installed
2. Lower the hood halfway (lifted approximately 30 cm (12 in.) from the closed position) and push down to securely lock in place. Then double check to be sure the hood is secure. If the hood can be raised slightly, it is not securely locked. Open it again and close it with more force.

WARNING

- Before closing the hood, ensure all obstructions are removed from around the hood opening. The hood will rise up or move down automatically if the height is not firmly adjusted. Be aware of the damage caused by the unintended hood movements.
- Always double check to be sure that the hood is firmly latched before driving away. Check there is no hood open warning light or message displayed on the instrument cluster. Driving with the hood opened may cause a total loss of visibility, which might result in an accident.
- Do not move the vehicle with the hood in the raised position, as vision is obstructed, which might result in an accident, and the hood could fall or be damaged.

Front trunk

Opening the Front Trunk

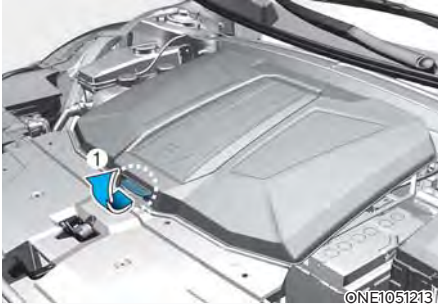

- Open the hood
- Lift up the front trunk cover while depressing the front trunk lever (1).

Closing the Front Trunk

Push down the front trunk cover to the right position.

Information

Available front trunk weight

- 2WD : 55 lbs. (25 kg)
- AWD : 25 lbs. (10 kg)

Available front trunk weight depends on the specifications.

WARNING

- **NEVER** make an attempt to get inside the front trunk. It will cause a fatal injury.
- Before closing the hood, ensure all obstructions are removed from around the hood opening. The hood will rise up or move down automatically if the height is not firmly adjusted. Be aware of the damage caused by the unintended hood movements.

- Never store cigarette lighters, propane cylinders, or other flammable/explosive materials in the vehicle. These items may catch fire and/or explode if the vehicle is exposed to hot temperatures for extended periods.

CAUTION

- Do not exceed the luggage volume capacity of the front trunk. The overweighted front trunk can be severely damaged.
- Do not store the fragile objects in the front trunk.
- **ALWAYS** keep the front trunk cover closed securely while driving. Items inside your vehicle are moving as fast as the vehicle. If you have to stop or turn quickly, or if there is a crash, the items can be damaged.
- Do not spray water in the front trunk. Vehicle driving system may get damaged since the front trunk is located at the center of motor compartment.
- Be careful when you store any liquid in the front trunk. If liquid leak outside the front trunk, it will cause a damage to the electric devices in the motor compartment.
- Do not press the front trunk cover or place the objects on the front trunk cover. It may be deformed or damaged.
- When closing the front trunk cover, be careful not to touch objects inside the trunk. Loaded objects or the front trunk may be deformed or damaged and the front trunk cover may be opened during driving due to poor closing, resulting in joints and damage.

NOTICE

To avoid possible theft, do not leave valuables in the storage compartments.

Power Liftgate (If equipped)

Power liftgate operating conditions

The power liftgate operates when the gear is in P (Park) with the vehicle running. However, the power liftgate will operate regardless of the gear position when the vehicle is off. Also, the liftgate can be opened only when vehicle speed is below 1.8 mph (3 km/h).

For safety, before attempting to open or close the liftgate, make sure the vehicle is in P (Park).



WARNING

- **Never leave children or animals unattended in your vehicle. Children may operate the power liftgate. Doing so can result in injury to themselves or others and can damage the vehicle.**

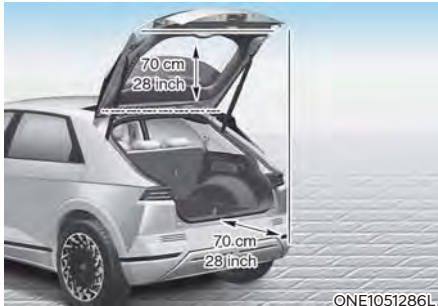

- **Make sure that there are no people or objects in the path of the power liftgate or smart liftgate prior to use. Serious injury, damage to the vehicle or damage to surrounding objects (for example, walls, ceilings, vehicles, etc.) may result if contact with the liftgate occurs.**

NOTICE

- **Do not close or open the liftgate manually. This may cause damage to the power liftgate. If it is necessary to close or open the liftgate manually when the battery is discharged or disconnected, do not apply excessive force.**
- **Do not operate the power liftgate more than 10 times continuously when the vehicle is not running. Use the power liftgate with the vehicle running when the power liftgate is used repeatedly to prevent battery discharge.**
- **Do not leave the power liftgate open for a long period of time. This may drain the battery.**
- **Do not apply excessive force when the power liftgate is operating. Doing so could result in vehicle damage.**



- **Do not grab or hold on to the liftgate support struts at any time. Damage to the liftgate support struts could result. Deformation of the liftgate support struts may cause vehicle damage and personal injury may occur.**
- **Do not modify or repair any part of the power liftgate by yourself. This must be done by an authorized HYUNDAI dealer.**

- **Do not operate the power liftgate under the following conditions. The power liftgate may not operate properly.**
 - One side of the vehicle is lifted to inspect the vehicle or change a tire
 - Parking on an uneven road such as a slope, etc.
- **Close the liftgate completely and lock all doors and liftgate using the central door lock button before using an automatic car wash.**
- **Do not spray high pressure water directly on the power liftgate outside open/close button. The liftgate may open unintentionally.**

Information

- **If the liftgate is not fully closed and vehicle speed is at or above 1.8 mph (3 km/h), a warning will sound 10 times. Immediately park the vehicle at a safe place, close the liftgate, and check that the liftgate open warning on the instrument cluster is turned off.**
- **In cold and wet climates, the outside power liftgate open/close button may not work properly due to freezing conditions. If this occurs, remove the ice before using the outside power liftgate open/close button or use the power liftgate open/close button on the smart key or the instrument panel.**
- **Operating the power liftgate more than 5 times continuously could cause damage to the operating motor. If this occurs, the power liftgate will not operate to prevent the motor from overheating. If any of the power liftgate buttons are pressed to try to open the liftgate, the chime will sound 3 times, but the liftgate will remain closed. Allow the power liftgate system to cool for about 1 minute before operating the system again.**

Operating the power liftgate

Power liftgate open/close button (Smart key, Instrument panel)



When the liftgate is closed, press the power liftgate open/close button for 1 second. The power liftgate opens with a warning sound.

While the liftgate is opening, press the button to stop liftgate operation.

When the power liftgate is opened, press and hold the power tailgate open/close button to close the liftgate. If you release the button while the tailgate is closing, power liftgate operation will stop with a warning sound for 5 seconds.

Also, if the smart key is not within operation range (approximately 394 in.(10 m)) from the vehicle, power liftgate operation will stop with a warning sound for 5 seconds.

Power liftgate open/close button (Outside the power liftgate)



When the liftgate is closed, press the power liftgate open/close button (1) to open the liftgate.

If the vehicle is locked, press the power liftgate open/close button (1) with the smart key in your possession.

If the liftgate is unlocked, the liftgate will open or close with a warning sound when the power liftgate open/close button (1) is pressed without carrying the smart key.

Power liftgate open/close button (Inside the power liftgate)



Press the power liftgate open/close button. The liftgate opens or closes with a warning sound.

Automatic reverse

During power liftgate operation if the power liftgate senses any obstacle, the liftgate will stop or will fully open. The automatic reverse feature may not operate properly, or it may operate unexpectedly under the following circumstances:

- The automatic reverse feature may not detect the resistance if the detected resistance is below a certain level, or if the liftgate is almost fully closed near the latched position.
- The automatic reverse feature may operate if a strong impact is applied with no obstructions placed.



WARNING

Never intentionally place any object or part of your body in the path of the power liftgate to make sure the automatic reverse feature operates. Serious injury, or damage to the vehicle or object may occur.



Information

The power liftgate may stop operating if the automatic reverse feature operates more than two times while attempting to open or close the liftgate. If this occurs, carefully open or close the liftgate manually, and then after 30 seconds try to operate the power liftgate automatically again.

Setting the power liftgate

To use each feature, you must select the opening speed or opening height from the settings menu. Deselect the settings when you do not want to use the feature.

Power liftgate opening speed

To adjust the power liftgate speed, select 'Setup → Vehicle Settings → Door/liftgate → Power liftgate Opening Speed → Fast/Slow' in the infotainment system. (Default setting is 'Fast'.)

Power liftgate opening height

To adjust the power liftgate opening height, select 'Setup → Vehicle Settings → Door/liftgate → Power liftgate Opening Height → Full Open/Level 3/Level 2/Level 1/User Height Setting' in the infotainment system.

The infotainment system may change after updates. See additional information in supplied Infotainment Manual.

User height setting

1. Position the liftgate manually to the height you prefer.
2. Press the power liftgate open/close button located inside the liftgate for more than 3 seconds. If 'User Height Setting' is selected for the power liftgate opening height, the power liftgate will automatically open to the height manually set by you.

Information

- **If the power liftgate opening height has not been manually set, the power liftgate will fully open when 'User Height Setting' from the infotainment system is selected.**
- **If one of the height setting (Full Open/Level 3/Level 2/Level 1) is selected from the settings menu in the infotainment system, and then 'User Height Setting' is selected, the liftgate will open to the height manually set by you.**
- **The power liftgate opening speed and opening height settings change according to the linked User Profile. If the User Profile is changed, power liftgate opening speed and opening height settings will change accordingly.**

Resetting the power liftgate

In some circumstances resetting the power liftgate operation may need to be performed. Some instances where resetting the power liftgate may be required include:

- When the 12-volt battery is recharged
- When the 12-volt battery is reinstalled after removal or replacement
- When the related fuse is reinstalled after removal or replacement



1. With the vehicle off or running, put the gear in P (Park).
2. Press the power liftgate open/close inner button simultaneously until a chime sounds.
3. Slowly close the liftgate manually.
4. Press the power liftgate open/close outer button. The power liftgate will open with a chime sound. Wait until the liftgate fully opens to complete resetting. If the liftgate stops before it is fully open, resetting cannot be completed.

i Information

If the power liftgate does not operate properly after the above procedure, have the system inspected by an authorized HYUNDAI dealer.

Emergency liftgate safety release



To unlock and open the liftgate manually from inside the luggage compartment, perform the following procedure:

1. Insert a long, flat object, such as a key into the opening at the bottom of the liftgate.
2. Slide the latch in the direction of the arrow to unlock the liftgate.
3. Push the liftgate to open.

! WARNING

- **For emergencies, be fully aware of the location of the emergency liftgate safety release latch in the vehicle and how to open the liftgate if you are accidentally locked in the luggage compartment.**
- **No one, including animals, should be allowed to occupy the luggage compartment of the vehicle at any time. The luggage compartment is a very dangerous location in the event of an accident.**
- **Use the release latch for emergencies only. Use extreme caution, especially while the vehicle is in motion.**

Smart Liftgate (if equipped)

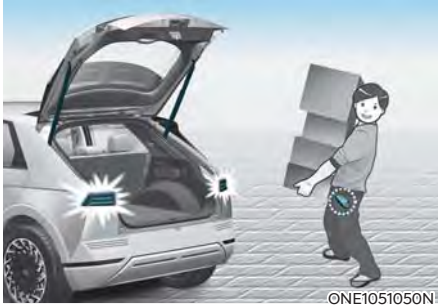

On a vehicle equipped with a smart key, the liftgate can be opened with hands-free activation using the smart liftgate system.

Using smart liftgate

The hands-free smart liftgate system can be opened automatically when the following conditions are met:

- The smart liftgate option is enabled in the Settings menu in the infotainment system screen.
- The smart liftgate is activated and ready 15 seconds after all the doors are closed and locked.
- The smart liftgate will open when the smart key is detected in the area behind the vehicle for 3 seconds.
- When disconnecting the charging connector, the smart liftgate is activated.

i Information

The smart liftgate will **NOT** operate when:

- A door is not locked or closed.
- The smart key is detected within 15 seconds from when the doors were closed and locked.
- The smart key is detected within 15 seconds after the doors are closed and locked, and within 1.5 m (60 in.) from the front door handles. (for vehicles equipped with Welcome Mirror).
- The smart key is in the vehicle.
- The vehicle is on charge.

1. Settings

To use smart liftgate, it must be enabled from the Settings menu in the infotainment system screen. Select:

- Setup → Vehicle Settings → Door/Liftgate → Smart Liftgate

For detailed information, refer to the separately supplied infotainment system manual.

2. Detect and Alert

The smart liftgate detecting area extends approximately 50-100 cm (20-40 in.) behind the vehicle. If you are positioned in the detecting area and are carrying the smart key, the hazard warning lights will blink and the chime will sound to alert you that the smart liftgate will open.

i Information

Do not approach the detecting area if you do not want the liftgate to open. If you have unintentionally entered the detecting area and the hazard warning lights and chime starts to operate, move away from the area behind the vehicle with the smart key. The liftgate will remain closed.

3. Automatic opening

After the hazard warning lights blink and the chime sounds 6 times, the smart liftgate will open.

Deactivating smart liftgate

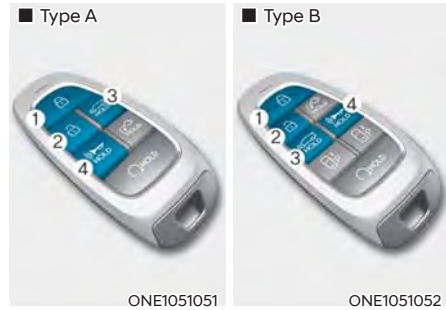

1. Door lock
2. Door unlock
3. Liftgate open/close
4. Panic

If you press any button on the smart key during the Detect and Alert stage, the smart liftgate will be deactivated.

Make sure to be aware of how to deactivate the smart liftgate for emergency situations.

- If you press the door unlock button (2), the smart liftgate will be deactivated temporarily. But, if you do not open any door for 30 seconds, the smart liftgate will be activated again.
- If you press the liftgate open button (3) for more than 1 second, the liftgate opens.
- The smart liftgate will still be activated if you press the door lock button (1) or liftgate open/close button (3) on the smart key as long as the smart liftgate is not already in the Detect and Alert stage.
- In case you have deactivated the smart liftgate by pressing the smart key button and opened a door, the smart liftgate can be activated again by closing and locking all doors.

Detecting area

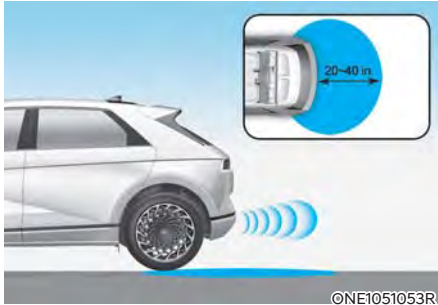

- The smart liftgate detecting area extends approximately 50-100 cm (20-40 in.) behind the vehicle. If you are positioned in the detecting area and are carrying the smart key, the hazard warning lights will blink and the chime will sound for about 3 seconds to alert you that the liftgate will open.
- The alert stops once the smart key is moved outside of the detecting area within the 3 second period.

i Information

- **Smart liftgate may not operate properly if any of the following occur:**
 - **The smart key is close to a radio transmitter such as a radio station or an airport which can interfere with normal operation of the transmitter.**
 - **The smart key is near a mobile two way radio system or a mobile phone.**
 - **Another vehicle's smart key is being operated close to your vehicle.**
- **Smart liftgate detecting area may change when:**
 - **The vehicle is parked on an incline or slope.**
 - **One side of the vehicle is raised or lowered relative to the opposite side.**

ELECTRIC CHARGING DOOR

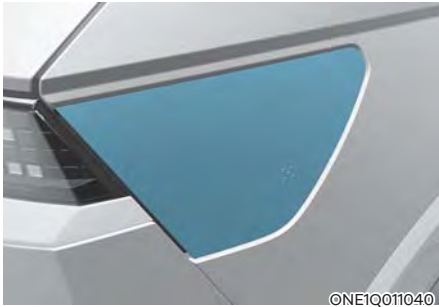

The driver can open and close the charging door with the following methods:

- When the shift gear is in P (Park), push the charging door to open/close
- Push the Close button located inner part of the charging door
- Press the charging door button in the smart key
- Use the Voice Recognition

NOTICE

- If the charging door does not open because ice has formed around it, tap lightly or push on the door to break the ice and release the door. If necessary, use hand temperature to melt down the ice or move the vehicle to a warm place and allow the ice to melt. Do not pry on the charging door or use unauthorized tools to open the charging door.
- After closing the charging door, push the door again to ensure that the charging door is completely closed.
- Make sure that the charging door is closed before driving the vehicle. If the charging door is opened, mechanical parts of the charging door can be damaged.
- After closed the charging door, be sure to check the warning light is off.

- After charging the vehicle, close the charging inlet by the charging inlet cover properly. If the charging inlet cover is closed improperly, the charging inlet and the charging door can be damaged.
- Do not pry on the charging door while the charging door is opening. The charging door may stop moving. Also, the electrical mechanism of the charging door and its related parts can be severely damaged.
- While washing the vehicle, do not spray a high pressure water to the charging door directly. The high pressure can damage the charging door.



CAUTION

- The charging door opens upwards. Check the surrounding while the charging door is open or close. Be aware of your head or limbs from being hit or stuck to the charging door.
- Do not hold the hinge to prevent damaging the charging door and causing other accidents.



Information

- The charging door automatically closes when:
 - The charging connector is disconnected
 - The door is opened and the charging connector is not connected for a certain period of time
 - The gear is not in P (Park)
- After replacing battery (12 volt), open and close the charging door once to check that the charging door automatic opening mechanism is functioning properly.

For more details, refer to “Charging Electric Vehicle” section in chapter 1.

AUGMENTED REALITY HUD (IF EQUIPPED)



The Head-Up Display is an optional feature that allows the driver to view information projected onto a transparent screen while still keeping your eyes safely on the road ahead while driving.

Head-up Display Settings

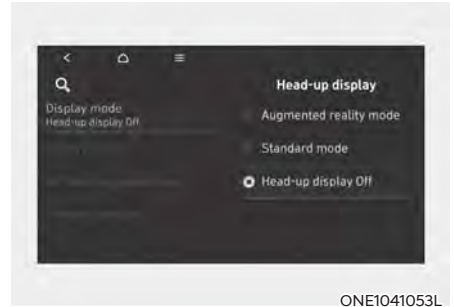

- Head-up display can be enabled from the Settings menu in the infotainment system screen. Select either Augmented Reality (AR) mode or Standard mode from:
 - Setup → Vehicle → Head-Up Display → Display mode → Augmented reality mode / Standard mode
- After turning on the head-up display, you can change the settings of 'Display control', 'AR Matching Adjustment' (When AR mode is selected) and 'Content selection' of the Head-up display.

i Information

Standard mode is the basic setting for Head-up display.

For detailed information, refer to the separately supplied infotainment system manual.

Head-up Display Information

AR mode display information



1. Turn by Turn (TBT) navigation information
2. Traffic signs or speed limit information
3. Speedometer information
4. SCC set speed information
5. SCC vehicle distance information
6. Lane Following Assist information
7. Lane Safety information
8. Blind-Spot Safety information
9. Highway Auto Speed Change information
10. Highway Driving Assist information
11. Turn by turn (TBT) navigation information (AR)
12. Lane Safety Information (AR)

13. Front Vehicle indicator (AR) (if Highway Lane Change Assist function equipped)
14. Leading Vehicle Departure Alert (AR)
15. Highway Lane Change Assist information (AR)

Standard mode display information



1. Turn by Turn (TBT) navigation information
2. Traffic information
3. Speedometer information
4. SCC set speed information
5. SCC vehicle distance information
6. Lane Following Assist information
7. Lane Safety information
8. Blind-Spot Safety information
9. Highway Auto Speed Change information
10. Highway Driving Assist information
11. Surrounding vehicle information

i Information

Standard Head-up display information may not be consistent based on the different system settings menu.

Precautions while Using the Head-up Display

- It may sometimes be difficult to read information on the Head-Up Display in the following situations.
 - The driver is improperly positioned in the driver's seat
 - The driver wears polarizing-filter sunglasses
 - An object is located above the head-up display cover
 - The vehicle is driven on a wet road
 - Any improper lighting accessory is installed inside the vehicle, or there is incoming light from outside of the vehicle
 - The driver wears glasses
 - The driver wears contact lenses

When it is difficult to read the Head-up display information, adjust the image position, brightness level or AR matching information from the Settings menu in the infotainment system screen.

- The AR mode display information may be difficult to recognize when the vehicle is driven under severe weather condition, such as heavy rain, heavy snow, low visibility, etc.
- Since the information displayed on the head-up display partially overlaps with the road ahead, you may feel fatigue and discomfort while driving. If you feel tired or uncomfortable, adjust the image, and if the symptoms persist, turn off the head-up display before driving.
- When the direct flash light or sunlight hits the front windshield, a warning message will appear. If the temperature of the front windshield keep rises, Head-up display will be deactivated temporarily to protect Head-up display from the high temperature. When the temperature drops, Head-up display will be reactivated.

- For your safety, make sure to stop the vehicle before adjusting the settings.
- Do not tint the front windshield glass or add other types of metallic coating. Otherwise, the Head-Up Display image may be invisible.
- Do not place any accessories on the crash pad or attach any objects on the windshield glass.
- When replacing the front windshield glass, replace it with a windshield glass designed for Head-Up Display operation. Otherwise, duplicated images may be displayed on the windshield glass.



WARNING

- **The warning information of Blind-Spot Safety on the Head-Up Display are supplemental. Do not solely depend on them to change lanes. Always take a look around before changing lanes.**

The driving route guidance display in the augmented reality mode is an auxiliary function. Be sure to check the navigation screen together.

- **ALWAYS pay attention on the road while driving when the Head-Up Display is on.**



Information

Head-Up Display includes GPL, LGPL, MPL and other open source license softwares. All license notices including related source code are provided at <http://www.mobis.co.kr/opensource/list.do>.

If the driver requests on-board software open source code via MOBIS_OSSrequest@mobis.co.kr within 3 years after buying this product, a CD-ROM or other storage device will be sent with the minimum cost covering storage device cost and delivery cost.

LIGHTING

Exterior Lights

Lighting control

To operate the lights, turn the knob at the end of the control lever to one of the following positions:

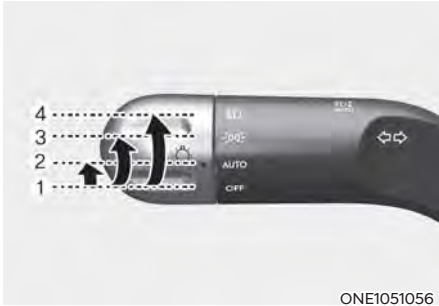

1. OFF
2. AUTO headlight
3. Parking lamp
4. Headlight

Daytime Running Light (DRL)

The Daytime Running Lights (DRL) can make it easier for others to see the front of your vehicle during the day, especially after dawn and before sunset.

The DRL system will turn the dedicated lamp OFF when :

- The headlights are ON.
- The parking brake is applied.
- The vehicle is turned off.

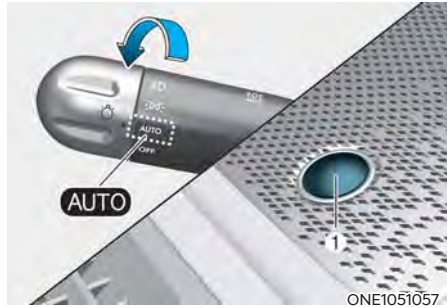

AUTO headlight

The parking lamp and headlight will be turned ON or OFF automatically depending on the amount of daylight as measured by the ambient light sensor (1) at the upper end of the windshield glass.

Even with the AUTO headlight feature in operation, it is recommended to manually turn ON the headlights when driving at night or in a fog, driving in the rain, or when you enter dark areas, such as tunnels and parking facilities.

NOTICE

- **Do not cover or spill anything on the sensor (1) located at the upper end of the windshield glass.**
- **Do not clean the sensor using a window cleaner, the cleanser may leave a light film which could interfere with sensor operation.**
- **If your vehicle window is tinted or other types of metallic coating are on the front windshield, the AUTO headlight system may not work properly.**



Parking lamp (☾☽)

The parking lamp, license plate lamp and instrument panel lamp are turned ON.



Headlight (☾☽)

The headlight, parking lamp, license plate lamp and instrument panel lamp are turned ON.

i Information

The Start/Stop button must be in the ON position to turn on the headlight.

High beam operation

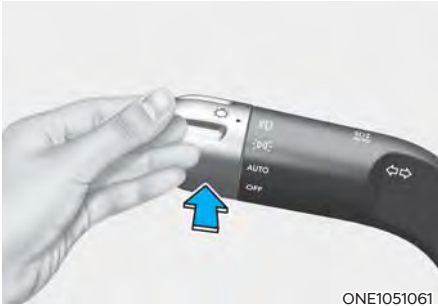

To turn on the high beam headlight, push the lever away from you. The lever will return to its original position.

The high beam indicator will light when the headlight high beams are switched on.

To turn off the high beam headlight, pull the lever towards you. The low beams will turn on.



To flash the high beam headlight, pull the lever towards you, then release the lever. The high beams will remain ON as long as you hold the lever towards you.

Turn signals and lane change signals

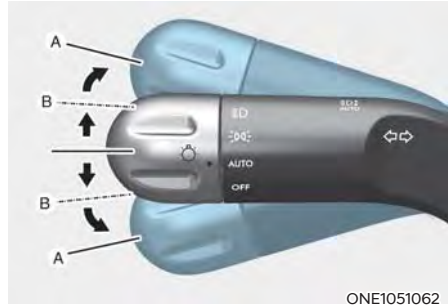

To signal a turn, push down on the lever for a left turn or up for a right turn in position (A).

If an indicator stays on and does not flash or if it flashes abnormally, one of the turn signal bulbs may be burned out and will require replacement.

One touch turn signal

To use One Touch Turn Signal push the turn signal lever up or down to position (B) and then release it.

The lane change signals will blink 3, 5 or 7 times.

You can enable the One Touch Turn Signal function or choose the number of blinking by selecting 'Setup → Vehicle Settings → Lights → One Touch Turn Signal (or One-touch indicator) → 3 flashes/5 flashes/7 flashes/Off' in the infotainment system screen.

For detailed information, refer to the separately supplied infotainment system manual.

Battery saver function

The purpose of this feature is to prevent the battery from being discharged.

The system automatically turns off the Parking lamp when the driver turns the vehicle off and opens the driver-side door.

With this feature, the Parking lamps will turn off automatically if the driver parks on the side of road at night.

However, the Parking lamps stay ON even when the driver-side door is opened if the light headlight switch is turned to the Parking lamp or AUTO (if equipped) position after the vehicle is turned off.

If necessary, to keep the lamps on turn the Parking lamps OFF and ON again using the headlight switch on the steering column after the vehicle is turned off.

Headlight delay function

If the Start/Stop button is in the ACC position or the OFF position with the headlights ON, the headlights (and/or Parking lamps) remain on for about 5 minutes. However, if the driver's door is opened and closed, the headlights are turned off after 15 seconds. Also, with the vehicle off if the driver's door is opened and closed, the headlights (and/or Parking lamps) are turned off after 15 seconds.

The headlights (and/or Parking lamps) can be turned off by pressing the lock button on the smart key twice or turning the headlight switch to the OFF or AUTO position.

You can enable the headlight delay function by selecting 'Setup → Vehicle Settings → Lights → Headlight Delay (or Headlight time-out)' in the infotainment system screen.

For detailed information, refer to the separately supplied infotainment system manual.

NOTICE

If the driver exits the vehicle through another door besides the driver door, the battery saver function does not operate and the headlight delay function does not turn OFF automatically.

This may cause the battery to discharge. To avoid battery discharge, turn OFF the headlights manually from the headlight switch before exiting the vehicle.

Interior Lights



WARNING

Do not use the interior lights when driving in the dark. The interior lights may obscure your view and cause an accident.

NOTICE

Do not use the interior lights for extended periods when the vehicle is turned off or the battery will discharge.

Interior lamp *AUTO cut*

The interior lamps will automatically go off approximately 20 minutes after the vehicle is turned off and the doors are closed. If a door is opened, the lamp will go off 25 minutes after the vehicle is turned off. If the doors are locked by the smart key and the vehicle enters the armed stage of the theft alarm system, the lamps will go off five seconds later.

Front lamps



Front map lamp ():

Touch either icons to turn the map lamp on or off. This light produces a spot beam for convenient use as a map lamp at night or as a personal lamp for the driver and the front passenger.

Door lamp ():

The front or rear room lamps come on when the front or rear doors are opened. When doors are unlocked by the smart key, the front and rear lamps come on for approximately 30 seconds as long as any door is not opened. The front and rear room lamps go out gradually after approximately 30 seconds when the door is closed. However, if the Start/Stop button is in the ON position or all doors are locked, the front and rear lamps will turn off. If a door is opened with the Start/Stop button in the ACC position or the OFF position, the front and rear lamps will stay on for about 5 minutes.

Room lamp ():

Press the button to turn ON the room lamp for the front/rear seats.

Mood lamp () (if equipped)

Press the button to turn On the mood lamp. Press again to turn the lamp off.

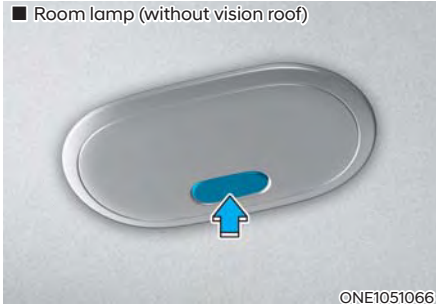

Rear lamps

- Room lamp (without vision roof)



- Personal lamp (with vision roof)





-  (Room lamp):
 (Personal lamp):
 Press the button to turn the lamp on or off.

Vanity mirror lamp



Push the switch to turn the light on or off.

- :
The lamp will turn on if this button is pressed.
- :
The lamp will turn off if this button is pressed.

NOTICE

Always have the switch in the off position when the vanity mirror lamp is not in use. If the sunvisor is closed without the lamp off, it may discharge the battery or damage the sunvisor.

Glove box lamp

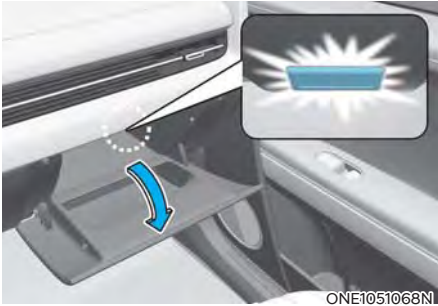

The glove box lamp turns on for about 20 minutes when the glove box is opened.

Door mood lamp (if equipped)



- Door mood lamp
To set the brightness and the color of the door mood lamp, select 'Setup → Vehicle Settings → Lights → Interior mood lamp'
- When driving at night or under low light driving conditions, the sensors detect the light level around the vehicle and automatically adjust the brightness of the mood lamp.
To set the automatic brightness adjustment turn On/Off, select 'Setup → Vehicle Settings → Lights → Interior Mood Lamp → Brightness control'
- There are different colors for different drive modes.
To set the colors for the different drive modes, select 'Setup → Vehicle Settings → Lights → Interior Mood Lamp → Colors for the drive modes'
- The color of the mood lamp turns red when the vehicle speed exceeds the speed limit in the speed control section.
To set the color change function, select 'Setup → Vehicle Settings → Lights → Interior Mood Lamp → Speed limit warning'

Luggage compartment lamp



The lamp turns on when the liftgate is opened.

Headlight and Parking lamp

When the light switch is ON, and all the doors (and liftgate) are closed and locked, the headlight and Parking lamp will turn on for approximately 15 seconds if the door unlock button is pressed on the smart key.

Select 'Setup → Lights → Headlight Delay' from the Settings menu to turn on this function.

For detailed information, refer to the separately supplied infotainment system manual.

Interior lamp

When the interior lamp switch is in the  position and all doors (and liftgate) are closed and locked, the room lamp will come on for 30 seconds if any of the below is performed.

- When the door unlock button is pressed on the smart key.
- When you touch the touch sensor on the door handle while carrying the smart key.

At this time, if you press the door lock or unlock button on the smart key the lamps will turn off immediately.

HIGH BEAM ASSIST (HBA) (IF EQUIPPED)

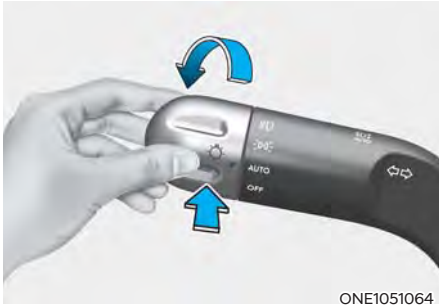

ONE1051064

High Beam Assist will automatically adjust the headlight range (switches between high beam and low beam) depending on the brightness of detected vehicles and certain road conditions.

Detecting sensor



ONE1071262

[1] : front view camera

The front view camera is used as a detecting sensor to detect ambient light and brightness while driving.

Refer to the picture above for the detailed location of the detecting sensor.

NOTICE

- Always keep the front view camera in good condition to maintain optimal performance of High Beam Assist.
- For more details on the precautions of the front view camera, refer to “Forward Collision-Avoidance Assist (FCA)” section in chapter 7.

High Beam Assist Settings

Setting features

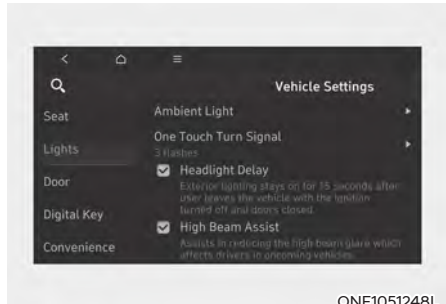

ONE1051248L

With the Start/Stop button in the ON position, select ‘Lights → High Beam Assist’ from the Settings menu to turn on High Beam Assist and deselect to turn off the function.



WARNING

For your safety, change the Settings after parking the vehicle at a safe location.

High Beam Assist Operation

Display and control

- After selecting 'High Beam Assist' in the Settings menu, High Beam Assist will operate by following the procedure below.
 - Place the headlight switch in the AUTO position and push the headlight lever towards the instrument cluster. The High Beam Assist (AUTO) indicator light will illuminate on the cluster and High Beam Assist will be enabled.
 - When High Beam Assist is enabled, high beam will turn on when vehicle speed is above 40 km/h (25 mph). When vehicle speed is below 25 km/h (15 mph), high beam will turn off.
 - The High Beam (H) indicator light will illuminate on the cluster when high beam is on.
- When High Beam Assist is operating, if the headlight lever or switch is used, High Beam Assist operates as follow:
 - If the headlight lever is pulled towards you when the high beam is off, the high beam will turn on without High Beam Assist canceled. When you let go of the headlight lever, the lever will move to the middle and the high beam will turn off.
 - If the headlight lever is pulled towards you when the high beam is on by High Beam Assist, low beam will turn on and the function will turn off.
 - If the headlight switch is placed from AUTO to another position (headlight/position/off), High Beam Assist will turn off and the corresponding lamp will turn on.
- When High Beam Assist is operating, high beam switches to low beam if any of the following conditions occur:
 - When the headlight of an oncoming vehicle is detected.
 - When the tail lamp of a vehicle in front is detected.
 - When the headlight or tail lamp of a motorcycle or a bicycle is detected.
 - When the surrounding ambient light is bright enough that high beams are not required.
 - When streetlights or other lights are detected.

Information

The images or colors may be displayed differently depending on the specifications of the instrument panel or theme.

High Beam Assist Malfunction and Limitations

High Beam Assist malfunction



When High Beam Assist is not working properly, the 'Check High Beam Assist (HBA) system' warning message will appear and  warning light will illuminate on the cluster. Have the function inspected by an authorized HYUNDAI dealer.

Limitations of High Beam Assist

High Beam Assist may not work properly in the following situations:

- Light from an oncoming or front vehicle is not detected because of lamp damage, or because it is hidden from sight, etc.
- Headlight of an oncoming or front vehicle is covered with dust, snow or water.
- A front vehicle's headlights are off, but the fog lamps are on, etc.
- There is a lamp that has a similar shape as a vehicle's lamp.
- Headlights have been damaged or not repaired properly.
- Headlights are not aimed properly.
- Driving on a narrow curved road, rough road, uphill or downhill.
- Vehicle in front is partially visible on a crossroad or curved road.

- There is a traffic light, reflecting sign, flashing sign or mirror ahead.
- There is a temporary reflector or flash ahead (construction area).
- The road conditions are bad such as being wet, iced or covered with snow.
- A vehicle suddenly appears from a curve.
- The vehicle is tilted from a flat tire or is being towed.
- Light from an oncoming or front vehicle is not detected due to obstacles in the air such as exhaust fume, smoke, fog, snow, or water spray or blizzard on the road, or fogging in the lamp, etc.

Information

For more details on the limitations of the Front View Camera, refer to "Forward Collision-Avoidance Assist (FCA)" section in chapter 7.

WARNING

- **At times, High Beam Assist may not work properly. High Beam Assist is for your convenience only. It is the responsibility of the driver for safe driving practices and always check the road conditions for your safety.**
- **When High Beam Assist does not operate properly, change the headlight position manually between high beam and low beam.**

WIPERS AND WASHERS

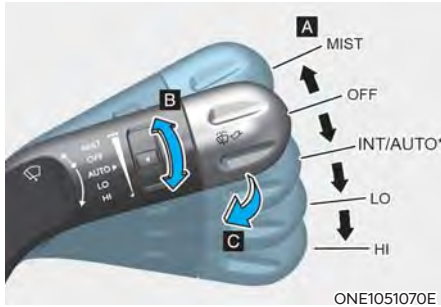

ONE1051070E

A. Wiper speed control

- MIST – Single wipe
- OFF – Off
- INT – Intermittent wipe
- AUTO* – Auto control wipe
- LO – Low wiper speed
- HI – High wiper speed

B. Intermittent wipe time adjustment/ Auto control wipe time adjustment*

C. Wash with brief wipes

* : if equipped

Front Windshield Wipers

Operates as follows when the Start/Stop button is in the ON position.

- MIST :** For a single wiping cycle, push the lever upward (or downward) and release. The wipers will operate continuously if the lever is held in this position.
- OFF :** Wiper is not in operation.
- INT :** Wiper operates intermittently at the same wiping intervals. To vary the speed setting, turn the speed control knob (B).
- AUTO :** The rain sensor located on the upper end of the windshield glass senses the amount of rainfall and controls the wiping cycle for the proper interval. The more it rains, the faster the wiper operates. When the rain stops, the wiper stops. To vary the speed setting, turn the speed control knob.
- LO :** The wiper runs at a lower speed.
- HI :** The wiper runs at a higher speed.

i Information

If there is heavy accumulation of snow or ice on the windshield, defrost the windshield for about 10 minutes, or until the snow and/or ice is removed before using the windshield wipers to ensure proper operation.

If you do not remove the snow and/or ice before using the wiper and washer, it may damage the wiper and washer system.

AUTO (Automatic) control



The rain sensor located on the upper end of the windshield glass senses the amount of rainfall and controls the wiping cycle for the proper interval.

The wiper operation time will be automatically controlled depends on rainfall.

When the rain stops, the wiper stops.

To vary the sensitivity setting, turn the sensitivity control knob.

If the wiper switch is set in AUTO mode when the Start/Stop button is in the ON position, the wiper will operate once to perform a self-check of the system. Set the wiper to the OFF position when the wiper is not in use.

WARNING

To avoid personal injury from the windshield wipers, when the vehicle is running and the windshield wiper switch is placed in the AUTO mode:

- Do not touch the upper end of the windshield glass facing the rain sensor.
- Do not wipe the upper end of the windshield glass with a damp or wet cloth.
- Do not put pressure on the windshield glass.

NOTICE

- When washing the vehicle, set the wiper switch in the OFF position to stop the auto wiper operation. The wiper may operate and be damaged if the switch is set in the AUTO mode while washing the vehicle.
- Do not remove the sensor cover located on the upper end of the passenger side windshield glass. Damage to system components could occur and may not be covered by your vehicle warranty.
- Because of using a photo sensor, temporary malfunction could occur according to sudden ambient light change made by stone and dust while driving.

Front Windshield Washers



In the OFF position, pull the lever gently toward you to spray washer fluid on the windshield and to run the wipers 1-3 cycles. The spray and wiper operation will continue until you release the lever. If the washer does not work, you may need to add washer fluid to the washer fluid reservoir.

Recirculating air when washer fluid is used

When washer fluid is used, in order to reduce any objectionable scent of the washer fluid from entering the cabin, recirculation mode and air conditioning are automatically activated depending on the outside temperature. If you select fresh mode while the function is operating, the function will resume after a certain amount of time. It may not work in some conditions such as cold weather or vehicle OFF.

For more details, refer to “Climate Control Additional Features” section in this chapter.

WARNING

When the outside temperature is below freezing, **ALWAYS** warm the windshield using the defroster to help prevent the washer fluid from freezing on the windshield and obscuring your vision which could result in an accident and serious injury or death.

NOTICE

- To prevent possible damage to the washer pump, do not operate the washer when the fluid reservoir is empty.
- To prevent possible damage to the wipers or windshield, do not operate the wipers when the windshield is dry.
- To prevent damage to the wiper arms and other components, do not attempt to move the wipers manually.
- To prevent possible damage to the wipers and washer system, use anti-freezing washer fluids in the winter season or cold weather.

AUTOMATIC CLIMATE CONTROL SYSTEM

■ Climate control panel



■ Infotainment System (Climate)

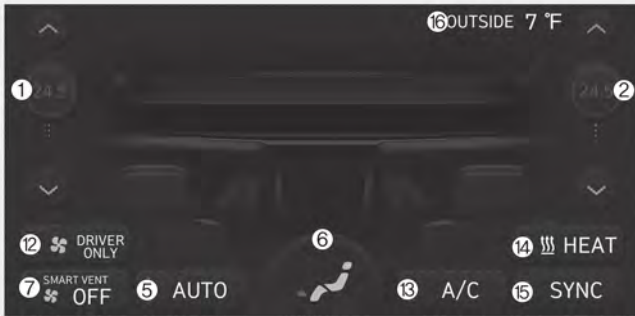

The actual shape may differ from the illustration.

ONE1051127L/ONE1051115N

1. Driver's temperature control
2. Passenger's temperature control
3. Display the air flow direction
4. View climate infotainment screen
5. AUTO (automatic control)
6. Mode selection button
7. Fan speed up
8. Fan speed down / OFF
9. Front windshield defroster
10. Rear windshield defroster
11. Air intake control
12. Driver only mode
13. A/C (air conditioning) ON/OFF
14. Heating ON/OFF
15. SYNC
16. Ambient temperature display
17. Seat warmer/air ventilation infotainment screen

i Information

Use a clean soft microfiber cloth to gently wipe any finger prints off the touch screen.

Climate

■ Infotainment System

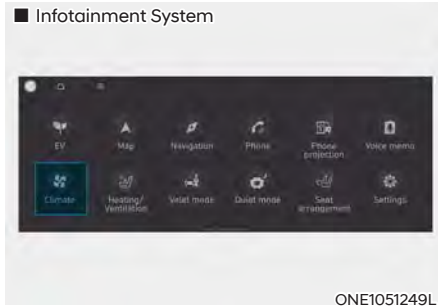

ONE1051249L

To view the climate information screen, select Climate in the main infotainment screen when the vehicle is ON.

■ Climate control panel



©NE1051111

Touch CLIMATE icon to view the climate information in the infotainment screen.

Automatic Temperature Control Mode

■ Type A



©NE1051101

□ Type B

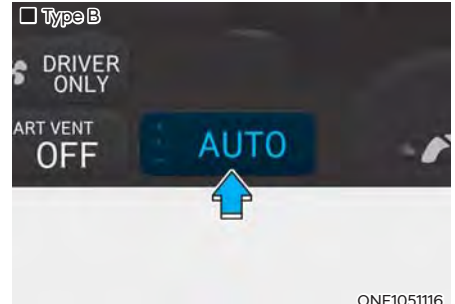

ONE1051116

Level	AUTO Indicator	Climate Information	Fan Speed level
3		HIGH	1~8
			
2		MEDIUM	1~6
			
1		LOW	1~4
			

1. Press AUTO icon or touch the AUTO icon in the infotainment screen to select the fan speed (level1~3)
2. Adjust the temperature with the temperature control icon.

The fan speed level only can be changed manually.

The following systems can be respectively adjusted while the AUTO climate control is On. When those systems are adjusted, AUTO indicator lights will turn off.

- Fan speed level
- A/C (Air condition)
- Mode selection
- Front windshield defroster (When defroster is turned off, AUTO indicator light will illuminate)

For your convenience and to improve the efficiency of the climate control, use the AUTO button and set the temperature to 72°F (22°C).

To change the temperature unit from °C to °F or °F to °C:

Select 'Setup → General Settings → Unit → Temperature Unit → °C/°F' from the Settings menu in the infotainment system screen.

i Information

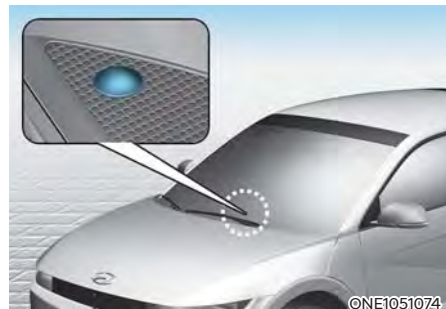



Never place anything near the ambient light/solar sensor to ensure better control of the heating and cooling system.

Manual Temperature Control Mode

The heating and cooling system can be controlled manually by selecting functions other than AUTO. In this case, the system works sequentially according to the order of the functions selected.

When selecting any other functions except AUTO while using automatic operation, the functions not selected will be controlled automatically.

1. Start the vehicle.
2. Set the mode to the desired position.
To improve the effectiveness of heating and cooling, select the mode according to the following:
 - Heating: 
 - Cooling: 
3. Set the temperature control to the desired value.
4. Set the air intake control to Fresh or Recirculation mode.
5. Set the fan speed control to the desired speed.
6. If air conditioning is desired, turn the air conditioning system on.
7. Select AUTO to revert back to full automatic control of the system.

Mode selection



Air flow direction

Touch the air flow direction icon (1) or (2) in the infotainment screen to select the desired air flow direction. The selected air flow direction will be displayed on the infotainment screen.

■ Left-hand drive

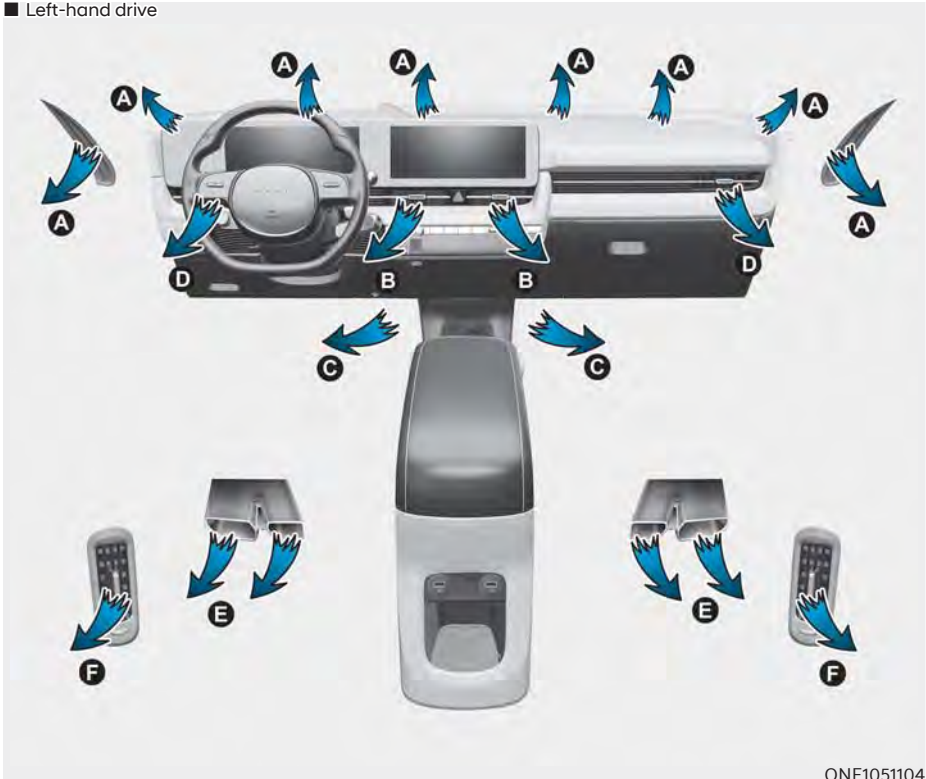

ONE1051104

Air flow direction

The mode selection Icon or button controls the direction of the air flow through the ventilation system.

**Face-Level (B, D, F)**

Air flow is directed toward the upper body and face. Additionally, each outlet can be controlled to direct the air discharged from the outlet.

**Bi-Level (B, D, C, E, F)**

Air flow is directed towards the face and the floor.

**Floor-Level (A, C, D, E)**

Most of the air flow is directed to the floor, with a small amount of the air being directed to the windshield and side window defrosters.

**Floor/Defrost-Level (A, C, D, E)**

Most of the air flow is directed to the floor and the windshield with a small amount directed to the side window defrosters.

**Defroster-Level (A, D)**

Most of the air flow is directed to the windshield with a small amount of air directed to the side window defrosters.

Front windshield defroster



Defrost-level (A, D)

Press the icon, and the indicator light will illuminate and the windshield defroster indicator will appear on the climate control panel.

Most of the air flow is directed to the windshield with a small amount of air directed to the side window defrosters.

When Defogging logic is enabled, Fresh mode is selected and air conditioning is selected according to outside temperature.

If the icon is pressed again, the indicator light will turn off and the previous settings will be selected.

Instrument panel vents

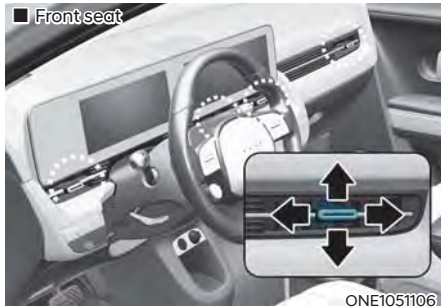

The instrument panel vent air flow can be directed up/down or left/right using the vent adjustment lever.

The air flow can also be CLOSED using the vent adjustment lever.

Front seat

- Move the lever away horizontally from the seat to close until the levers click and lock. Slightly move the lever toward the seating position to unlock and open.

Rear seat

- Move the lever downward to close the air flow. Move the lever upward to open the air flow.

Temperature control

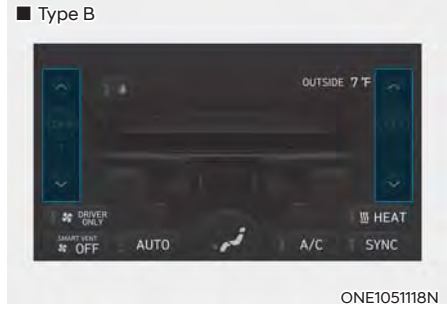
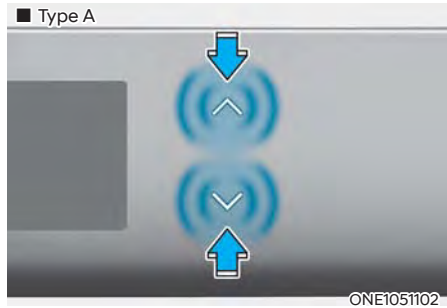

Touch the \wedge or \vee icon to select the temperature.

The temperature can be increased or decreased by increments of 1°F (0.5°C) for each incremental location. When set to the lowest temperature setting, the air conditioning will operate continuously to quickly cool the interior of the vehicle initially. After interior temperature has been cooled down sufficiently, select AUTO and set the temperature to 72 °F (22 °C).

SYNC**Adjusting the temperature and air flow direction equally**

Press SYNC (indicator light ON), the passenger's temperature and air flow direction will be adjusted same as the driver's control.

Adjusting the temperature and air flow direction individually

Press SYNC (indicator light OFF), all seats temperature and air flow direction will be adjusted individually.

Air intake control

Air intake control is used to select either Fresh mode (outside air) or Recirculation mode (cabin air).

Recirculation mode

When Recirculation mode is selected, air from the passenger compartment will be recirculated through the system and heated or cooled according to the function selected.

Fresh mode

When Fresh mode is selected, air enters the vehicle from outside and is heated or cooled according to the function selected.

i Information

Operating the system primarily in Fresh mode is recommended. Use Recirculation mode temporarily only when needed. Prolonged operation of the heater in Recirculation mode and without the air conditioning ON can cause fogging of the windshield. In addition, prolonged use of the air conditioning ON in Recirculation mode may result in excessively dry, dehumidified air in the cabin and may promote formation of musty vent odor due to stagnant air.

! WARNING

- Continued use of the climate control system operation in Recirculation mode for a prolonged period of time may cause drowsiness to the occupants in the cabin. This may lead to loss of vehicle control which may lead to an accident.
- Continued use of the climate control system operation in Recirculation mode with the air conditioning OFF may allow humidity to increase inside the cabin. This may cause condensation to accumulate on the windshield and obscure visibility.
- Do not sleep in your vehicle or remain parked in your vehicle with the windows up and either the heater or the air conditioning ON for prolonged periods of time. Doing so may increase the levels of carbon dioxide in the cabin which may lead to serious injury or death.

Fan speed control

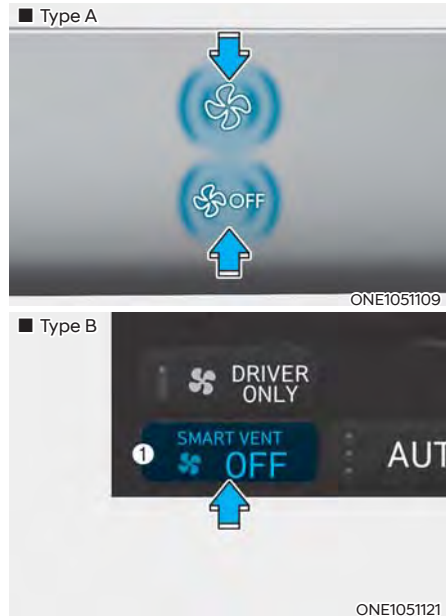

The fan speed can be set to the desired speed by adjusting the fan icon in the climate control panel.

More air is delivered with higher fan speeds.

Pressing the OFF icon or button turns off the fan.

You can check the fan speed and auto air circulation mode in the climate information screen icon (1) in the infotainment system.

i Information

To help improve microphone voice input sound, fan speed may automatically slow down for a couple of minutes when you activate voice recognition or hands free.

NOTICE

Operating the fan when the Start/Stop button is in the OFF position could cause the battery to discharge. Operate the fan when the vehicle is running.

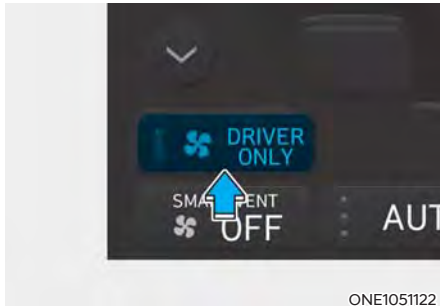
Driver only

ONE1051122

If you touch the DRIVER ONLY icon (🌀^{DRIVER ONLY}) and the indicator light illuminates in the infotainment climate control screen, cold air mostly blows in the driver's seat. However, some of the cold air may come out of other seating position ducts to keep indoor air pleasant.

If you use the icon with no passenger in the front passenger seat, energy consumption will be reduced.

DRIVER ONLY icon will be turned off under the following conditions:

- 1) Defrost on
- 2) DRIVER ONLY button re-touch

Air conditioning

ONE1051123

Touch the CLIMATE icon in the climate control panel. The climate information screen will appear on the infotainment screen. Touch the A/C icon in the infotainment screen to turn the air conditioning on (indicator light ON) and off.

HEAT icon

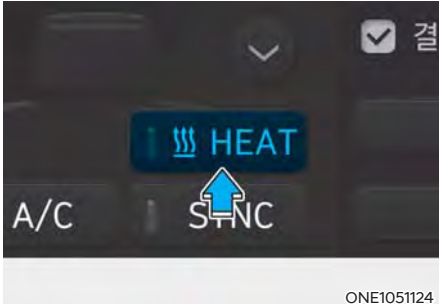

ONE1051124

Touch CLIMATE icon in the climate control panel. The climate information screen will appear on the infotainment screen. Touch the HEAT icon in the infotainment screen to turn the heater on (indicator light will illuminate).

Touch the button again to turn the heater off.

The air conditioner and heater uses energy from the battery. If you use the heater or air conditioner for too long, distance to empty can be reduced due to too much power consumption.

Turn off the heater and air conditioner if you do not need them.

OFF mode

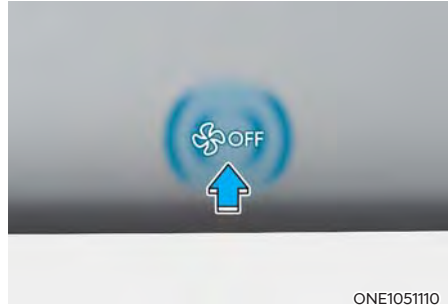

ONE1051110

Touch the OFF icon to turn the climate control system off. You can still operate mode selection and air intake control as long as the Start/Stop button is in the ON position.

System Operation

Cooling / Ventilation

1. Select the Face Level (👤) mode in the infotainment screen.
2. Set the air intake control to fresh or recirculation mode.
3. Set the temperature to the desired position.
4. Set the fan speed to the desired speed.

Heating

1. Select the Floor Level (👤) mode in the infotainment screen.
2. Set the air intake control to fresh or recirculation mode.
3. Set the temperature to the desired position.
4. Set the fan speed to the desired speed.
5. If desired, turn the air conditioning ON with the temperature set high in order to dehumidify the air before it enters into the cabin.

If the windshield fogs up, select the Front Defrost (🌬️) mode.

Operation Tips

- To keep dust or unpleasant fumes from entering the vehicle through the ventilation system, temporarily set the air intake control to the recirculation mode. Return the control to the Recirculation mode to the Fresh mode when the unpleasant air outside has diminished. This will help keep the driver alert and comfortable.
- To help prevent the inside of the windshield from fogging, set the air intake control to fresh mode and the fan speed to the desired position, turn on the air conditioning system, and adjust the temperature control to the desired temperature.

Air conditioning

Your HYUNDAI Vehicle air conditioning system is filled with R-1234yf refrigerant.

1. Touch the [CLIMATE] icon to display climate information the infotainment screen.
2. Select A/C icon (indicator light ON) in the climate information screen to activate the air-condition.
3. Set the temperature low.
4. Set the direction of air flow by touching the mode selection icon.
5. Touch the HEAT icon (indicator light OFF) to turn on the air-condition.

When maximum cooling is desired, set the temperature to the lowest position, then set the fan speed control to the highest setting.

Air conditioning system operation tips

- If the vehicle has been parked in direct sunlight during hot weather, open the windows for a short time to let the hot air inside the vehicle escape.
- After sufficient cooling has been achieved, switch back from recirculation mode to fresh mode.
- To help reduce moisture inside of the windows on rainy or humid days, decrease the humidity inside the vehicle by operating the air conditioning system with the windows and vision roof closed.
- Use the air conditioning system every month only for a few minutes to ensure maximum system performance.
- If you operate air conditioner excessively, the difference between the temperature of the outside air and that of the windshield could cause the outer surface of the windshield to fog up, causing loss of visibility. In this case, set the mode selection to the 👤 position and fan speed control to the lowest speed.

System Maintenance

Cabin air filter

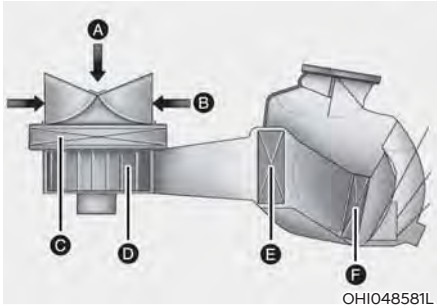

[A] : Outside air, [B] : Recirculated air
[C] : Cabin air filter, [D] : Blower
[E] : Evaporator core, [F] : PTC & Inner condenser

The cabin air filter is installed behind the front trunk. It filters the dust or other pollutants that enter the vehicle through the heating and air conditioning system.

Have the cabin air filter replaced by an authorized HYUNDAI dealer according to the maintenance schedule. If the vehicle is being driven in severe conditions such as dusty or rough roads, more frequent cabin air filter inspections and changes are required.

If the air flow rate suddenly decreases, have the system inspected at an authorized HYUNDAI dealer.

Checking the amount of air conditioner refrigerant and compressor lubricant

When the amount of refrigerant is low, the performance of the air conditioning is reduced. Overfilling also reduces the performance of the air conditioning system.

Therefore, if abnormal operation is found, have the system inspected by an authorized HYUNDAI dealer.

NOTICE

It is important that the correct type and amount of oil and refrigerant is used. Otherwise, damage to the compressor and abnormal system operation may occur. To prevent damage, the air conditioning system in your vehicle should only be serviced by trained and certified technicians.

NOTICE

The refrigerant system should only be serviced by trained and certified technicians to insure proper and safe operation.

The refrigerant system should be serviced in a well-ventilated place.

The air conditioning evaporator (cooling coil) shall never be repaired or replaced with one removed from a used or salvaged vehicle and new replacement MAC evaporators shall be certified (and labeled) as meeting SAE Standard J2842.

WARNING

Vehicles equipped with R-1234yf



Since the refrigerant is mildly flammable and operated at high pressure, the air conditioning system should only be serviced by trained and certified technicians. It is important that the correct type and amount of oil and refrigerant are used.

All refrigerants should be reclaimed with proper equipment.

Venting refrigerants directly to the atmosphere is harmful to individuals and environment. Failure to heed these warnings can lead to serious injuries.



Air Conditioning refrigerant label

You can find out which air conditioning refrigerant is applied to your vehicle on the label located inside of the hood.

■ Example



OHYK059002

Each symbol and specification on the air conditioning refrigerant label is represented as below:



1. Classification of refrigerant
2. Amount of refrigerant
3. Classification of compressor lubricant
4. Caution
5. Flammable refrigerant
6. To require registered technician to service air conditioning system

WINDSHIELD DEFROSTING AND DEFOGGING



WARNING

Windshield heating

Do not use the  position during cooling operation in extremely humid weather. The difference between the temperature of the outside air and that of the windshield could cause the outer surface of the windshield to fog up, causing loss of visibility could cause an accident resulting in serious injury or death. In this case, set the mode selection to the  position and fan speed control to a lower speed.

- For maximum defrost performance, set the temperature control to the highest temperature setting and the fan speed control to the highest setting.
- If warm air to the floor is desired while defrosting or defogging, set the mode to the floor-defrost position.
- Before driving, clear all snow and ice from the windshield, rear window, side view mirrors, and all side windows.
- Clear all snow and ice from the hood and air inlet in the cowl grill to improve heater and defroster efficiency and to reduce the probability of fogging up the inside of the windshield.

To Defog Inside Windshield

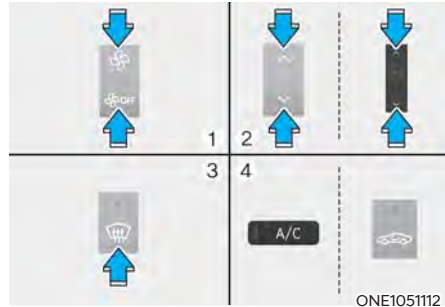

1. Select the desired fan speed.
2. Select the desired temperature.
3. Touch the defroster icon (.
4. When the defogging logic is enabled, Fresh mode is selected and air conditioning is selected according to outside temperature.

Check to make sure the air intake control is in Fresh mode. If the air intake control indicator light is illuminated, touch the icon once to enable Fresh mode (indicator light OFF).

If the  position is selected, the fan speed is automatically increased.

To Defrost Outside Windshield

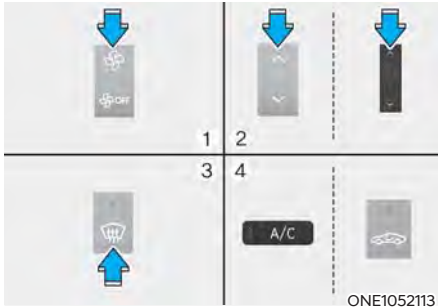

1. Set the fan speed to the highest position.
2. Set the temperature to the extreme hot position.
3. Touch the defroster icon (🌬️).
4. When Defogging logic is enabled, Fresh mode is selected and air conditioning is selected according to outside temperature.

Check to make sure the air intake control is in Fresh mode. If the air intake control indicator light is illuminated, touch the icon once to enable Fresh mode (indicator light OFF).

If the 🌬️ position is selected, lower fan speed is adjusted to a higher fan speed.

Defogging Logic

To reduce the probability of fogging up the inside of the windshield, the air intake or air conditioning are controlled automatically according to certain conditions such as 🌬️ positions. To cancel or reset the defogging logic, do the following.

1. Press the Start/Stop button to the ON position.
2. Touch the defroster icon (🌬️) or (🌬️).
3. While touching the A/C icon, touch the air intake control icon at least 5 times within 3 seconds.

The air intake control indicator will blink 3 times to indicate that the defogging logic has been disabled. Repeat the steps again to re-enable the defogging logic.

The air intake control indicator will blink 6 times to indicate that the defogging logic has been enabled.

If the battery has been discharged or disconnected, it resets to the defog logic status.

Rear Window Defroster

NOTICE

To prevent damage to the rear window defroster conducting elements bonded to the inside surface of the rear window, never use sharp instruments or window cleaners containing abrasives to clean the window.



The defroster heats the window to remove frost, fog and thin ice from the interior and exterior of the rear window, while the vehicle is running.

- To activate the rear window defroster, touch the rear window icon located in the center control panel. The indicator on the rear window defroster illuminates when the defroster is on.
- To turn off the defroster, touch the rear window defroster button again.

i Information

- If there is heavy accumulation of snow on the rear window, brush it off before operating the rear defroster.
- The rear window defroster automatically turns off after approximately 20 minutes or when the Start/Stop button is in the OFF position.

Side view mirror defroster

If your vehicle is equipped with the rearview mirror defrosters, they will operate at the same time you turn on the rear window defroster.

CLIMATE CONTROL ADDITIONAL FEATURES

A/C Automatic Drying (if equipped)

A/C Automatic Drying feature dries the moisture in the air conditioner and reduces air conditioner odor. The blower motor automatically operates after 30 minutes the vehicle is turned off.

Turning A/C Automatic Drying On or off

The A/C Automatic Drying feature can be turned on and off by selecting 'Setup → Vehicle Settings → Climate → Climate Features → A/C Automatic Drying' from the infotainment system. See additional information in supplied Infotainment Manual.

If the operating condition is satisfied after setting the feature, the operating condition is displayed on the infotainment system screen and the blower motor automatically operates.

When the A/C Automatic Drying feature is activated, the air conditioner sets the fan speed to the third level, selects Fresh mode, and directs the air flow to the floor.

Operating conditions

The A/C Automatic Drying feature operates under the following conditions:

The vehicle is turned off after operating the air conditioner for a certain period
The 12-volt battery level is sufficient
The outside temperature is above a certain level

Non-operating conditions

The A/C Automatic Drying feature stops operating under the following conditions:

- The A/C Automatic Drying feature has operated for 3 minutes
- The Start/Stop button is pressed, or the vehicle is on
- The climate control system is operated remotely

i Information

- **The A/C Automatic Drying feature reduces air conditioner odors but may not remove all odors.**
- **The A/C Automatic Drying feature does not operate if the remaining battery level is insufficient to prevent battery discharge.**

Auto Defogging System



Auto defogging helps reduce the possibility of fogging up the inside of the windshield by automatically sensing the moisture on inside the windshield.

i Information

The auto defogging system may not operate normally, when the outside temperature is below 14 °F (-10 °C).



When the Auto Defogging System operates, the indicator will illuminate.

If a high amount of humidity is detected in the vehicle, the Auto Defogging System will be enabled. The following steps will be performed automatically:

- Step 1) Air conditioning will turn ON.
- Step 2) Air intake control will change to Fresh mode.
- Step 3) Mode will change to defrost to direct airflow to the windshield.
- Step 4) Fan speed will be set to MAX.

If the air conditioning is off or recirculation mode is manually selected while Auto Defogging System is ON, the Auto Defogging System will be canceled.

Turning the Auto Defogging System ON or OFF

Climate control system

Touch the front windshield defroster icon for 3 seconds when the Start/Stop button is in the ON position. When the Auto Defogging System is turned off, the ADS OFF symbol will blink 3 times and ADS OFF will be displayed on the climate control information screen.

When the Auto Defogging System is turned on, the ADS OFF symbol will blink 6 times without a signal.

Infotainment system

Auto Defogging System can be turned on and off by selecting 'Setup → Vehicle Settings → Climate → Defog/Defrost Options → Auto Defog' from the infotainment system screen.

For detailed information, refer to the separately supplied infotainment system manual.

i Information

- **When the air conditioning is turned on by Auto Defogging System, if you try to turn off the air conditioning, the indicator will blink 3 times and the air conditioning will not be turned off.**
- **To maintain the effectiveness and efficiency of the Auto Defogging System, do not select Recirculation mode while the system is operating.**
- **When Auto Defogging System is operating, fan speed adjustment, temperature adjustment, and air intake control selection are all disabled.**

NOTICE

Do not remove the sensor cover located on the upper end of the windshield glass.

Damage to system parts could occur and may not be covered by your vehicle warranty.

Auto Dehumidify (if equipped)

To increase cabin air quality and reduce windshield misting, recirculation mode switches off automatically after about 5 minutes, depending on the outside temperature, and the air intake will change to fresh mode.

Turning Auto Dehumidify ON or OFF

Climate control system

To turn the Auto Dehumidify feature on or off, select Face level (👤) mode and touch the air intake control icon at least five times within three seconds. When Auto Dehumidify is turned on, the air intake control button indicator will blink 6 times. When turned off, the indicator will blink 3 times.

Infotainment system

Auto Dehumidify can be turned on and off by selecting 'Setup → Vehicle Settings → Climate → Automatic Ventilation → Auto Dehumidify' from the infotainment system screen.



Information

If the battery (12V) is discharged or disconnected, Auto dehumidify settings will be reset. Readjust the settings to turning Auto dehumidify option ON or OFF.

For detailed information, refer to the separately supplied infotainment system manual.

Recirculating Air When Washer Fluid Is Used

Recirculation mode automatically activates to reduce any objectionable scent of the washer fluid from entering the cabin when the windshield washer is used.

Turning Activate upon Washer Fluid Use ON or OFF

Activate upon Washer Fluid Use can be turned on and off by selecting 'Setup → Vehicle Settings → Climate → Recirculate Air → Activate upon Washer Fluid Use (or Interlocking washer fluid)' from the infotainment system screen.

For detailed information, refer to the separately supplied infotainment system manual.

Auto. Controls That Use Climate Control Settings (for driver's seat)

The temperature of the driver's seat warmer, air ventilated seat and heated steering wheel is automatically controlled depending on the inside and outside temperature of the vehicle when the vehicle is running.

To use these features, it must be enabled from the Settings menu in the infotainment system screen. Select:

- Setup → Vehicle Settings → Seat → Heated/Ventilated Features → Heated/Ventilated Features → Auto. Controls That Use Climate Control Settings

For more details on Auto Comfort Control, refer to “Seat Warmers” and “Air ventilation seats” section in chapter 3 and “Heated Steering Wheel” section in this chapter.

Smart Ventilation

The smart ventilation system maintains pleasant/fresh air condition inside the passenger compartment by automatically detecting/controlling the temperature and humidity, when you drive the vehicle with the climate control system in the OFF position. When the smart ventilation system starts to operate, the message “SMART VENTILATION ON” appears for 5 seconds.

- The smart ventilation system stops operating, when the BLOWER DOWN OFF button of the climate control system is selected.
- The smart ventilation system stops operating, when any button of the climate control system is selected for operation.
- The smart ventilation system may not operate, when the vehicle is driven at low speed.

STORAGE COMPARTMENT

WARNING

Never store cigarette lighters, propane cylinders, or other flammable/explosive materials in the vehicle. These items may catch fire and/or explode if the vehicle is exposed to hot temperatures for extended periods.

WARNING

ALWAYS keep the storage compartment covers closed securely while driving. Items inside your vehicle are moving as fast as the vehicle. If you have to stop or turn quickly, or if there is a crash, the items may fly out of the compartment and may cause an injury if they strike the driver or a passenger.

NOTICE

To avoid possible theft, do not leave valuables in the storage compartments.

Center Console Storage Console Box



To open :

Grab and hold the latch on the arm rest then lift the lid.

- This space provides objects storing compartment.

Console Storage



This space provides object storing compartment.

Sliding console (if equipped)

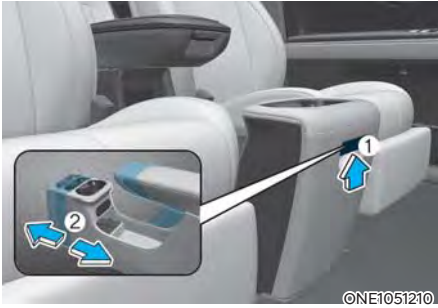

To slide the console (2) forward/backward, pressing the handle (1) and pull or push the console to the desired position.

Check if the console box makes a 'click' sound, after moving the center console box.

NOTICE

Use of excessive force to the console box may damage the sliding rail or the control lever.

Glove Box

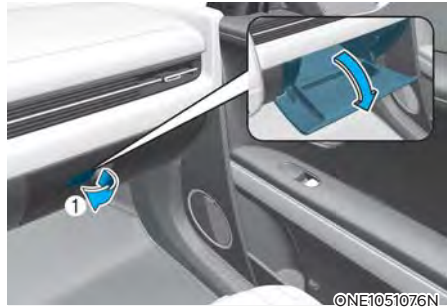

To open:
Pull the lever (1).

WARNING

ALWAYS close the glove box door after use.

An open glove box door can cause serious injury to the passenger in an accident, even if the passenger is wearing a seat belt.

NOTICE

Use of excessive force to the glove box may damage the sliding rail or the lever.

INTERIOR FEATURES

Cup Holder

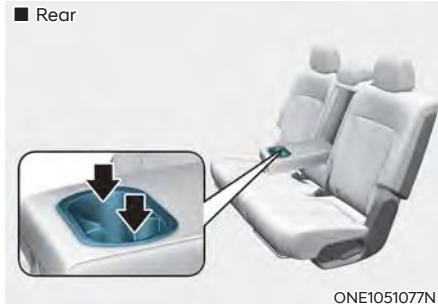

Cups or small beverages cups may be placed in the cup holders.

WARNING

- Avoid abrupt starting and braking when the cup holder is in use to prevent spilling your drink. If hot liquid spills, you could be burned. Such a burn to the driver could cause loss of vehicle control resulting in an accident.
- Do not place uncovered or unsecured cups, bottles, cans, etc., in the cup holder containing hot liquid while the vehicle is in motion. Injuries may result in the event of a sudden stop or collision.
- Only use soft cups in the cup holders. Hard objects can injure you in an accident.

WARNING

Keep cans or bottles out of direct sun light and do not put them in a hot vehicle. It may explode.

NOTICE

- Keep your drinks sealed while driving to prevent spilling your drink. If liquid spills, it may get into the vehicle's electrical/electronic system and damage electrical/electronic parts.
- When cleaning spilled liquids do not use hot air to blow out or dry the cup holder. This may damage the interior.

Sunvisor

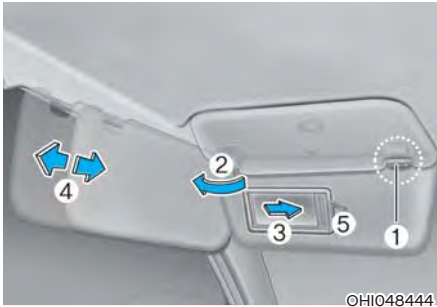

To use the sunvisor, pull it downward.

To use the sunvisor to block the sun from the side window, pull it downward, release it from the bracket (1) and swing it to the side (2) towards the window.

To use the vanity mirror, pull down the sunvisor and slide the mirror cover (3).

Adjust the sunvisor forward or backward (4) as needed (if equipped). Use the ticket holder (5) to hold tickets.

Close the vanity mirror cover securely and return the sunvisor to its original position after use.



WARNING

For your safety, do not block your view when using the sunvisor.

NOTICE

- The tab (5) adjacent to the vanity mirror on the sunvisor can be used for toll road tickets or self parking tickets. Use caution when inserting tickets into the ticket holder to avoid damage. Refrain from putting several tickets in the ticket holder as this could also damage the retaining tab.
- Always have the switch in the off position when the vanity mirror lamp is not in use. If the sunvisor is closed without the lamp off, it may discharge the battery or damage the sunvisor.

Power Outlet

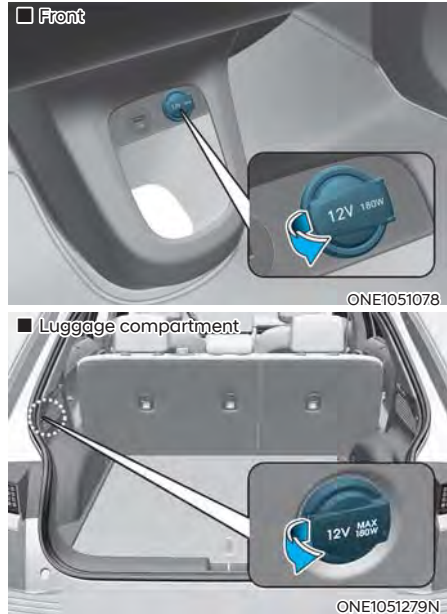

The power outlet is designed to provide power for mobile telephones or other devices designed to operate with vehicle electrical systems. The devices should draw less than 180 watts with the vehicle running.

WARNING

Avoid electrical shocks. Do not place your fingers or foreign objects (pin, etc.) into a power outlet or touch the power outlet with a wet hand.

NOTICE

To prevent damage to the power outlets:

- Use the power outlet only when the vehicle is running and remove the accessory plug after use. Using the accessory plug for prolonged periods of time with the vehicle off could cause the battery to discharge.
- Only use 12 volts electric accessories which are less than 180 watts in electric capacity.
- Adjust the air-conditioner or heater to the lowest operating level when using the power outlet.
- Close the cover when not in use.
- Some electronic devices can cause electronic interference when plugged into a vehicle's power outlet. These devices may cause excessive audio static and malfunctions in other electronic systems or devices used in your vehicle.
- Push the plug in as far as it will go. If good contact is not made, the plug may overheat and the fuse may open.
- Plug in battery equipped electrical/ electronic devices with reverse current protection. The current from the battery may flow into the vehicle's electrical/electronic system and cause system malfunction.

USB Charger (if equipped)

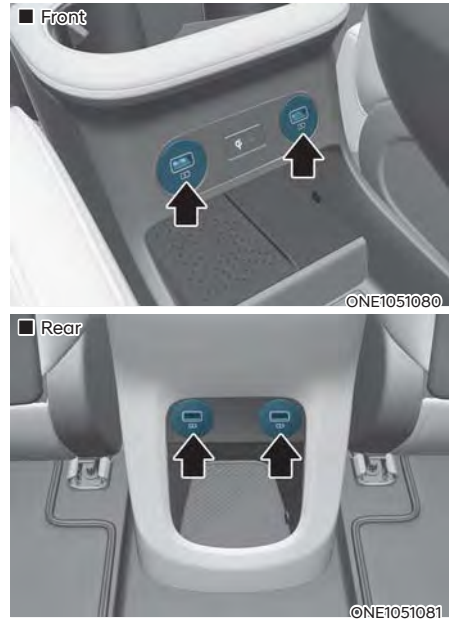

The USB charger is designed to recharge batteries of small size electrical devices using a USB cable.

The electrical devices can be recharged when the Start/Stop button is in the ON or START position.

The battery charging state may be monitored on the electrical device.

Disconnect the USB cable from the USB port after use.

- A smart phone or a tablet PC may get warmer during the re-charging process. It does not indicate any malfunction with the charging system.
- A smart phone or a tablet PC, which adopts a different re-charging method, may not be properly re-charged. In this case, use an exclusive charger of your device.
- The charging terminal is only to recharge a device. Do not use the charging terminal either to turn ON an audio or to play media in the infotainment system.

NOTICE

- **Use the USB charger when the vehicle is running. Using the USB charger for prolonged periods of time with the vehicle off could cause the battery to discharge.**
- **To prevent damage to the USB charger:**
 - **Do not insert foreign objects or spill liquid into the outlet. The USB charging terminal may be damaged.**
 - **Do not use devices with current consumption exceeding 2,100 mA (2.1 A).**

Wireless Smart Phone Charging System (if equipped)



[A] : Indicator light, [B] : Charging pad

On certain models, the vehicle comes equipped with a wireless smart phone charger.

The system is available when all doors are closed, and when the Start/Stop button is in the ON or START position.

Charging smart phone

The wireless smart phone charging system charges only the Qi-enabled smart phones (Qi). Read the label on the smart phone accessory cover or visit your smart phone manufacturer's website to check whether your smart phone supports the Qi technology.

The wireless charging process starts when you put a Qi-enabled smart phone on the wireless charging unit.

1. Remove other items, including the smart key, from the wireless charging unit. If not, the wireless charging process may be interrupted. Place the smart phone on the center of the charging pad.
2. The indicator light is orange when the smart phone is charging. The indicator light will turn blue when phone charging is complete.
3. You can turn ON or OFF the wireless charging function from the Settings menu in the infotainment system screen. Select:
 - Setup → Vehicle → Convenience → Wireless Charging

For detailed information, refer to the separately supplied infotainment system manual.

If your smart phone is not charging:

- Slightly change the position of the smart phone on the charging pad.
- Make sure the indicator light is orange.

The indicator light will blink orange for 10 seconds if there is a malfunction in the wireless charging system.

In this case, temporarily stop the charging process, and re-attempt to charge your smart phone again.

The system warns you with a message on the LCD display if the smart phone is still on the wireless charging unit after the vehicle is turned OFF and the front door is opened.

For some manufacturer's smart phones, the system may not warn you even though the smart phone is left on the wireless charging unit. This is due to the particular characteristic of the smart phone and not a malfunction of the wireless charging.

NOTICE

- **The wireless smart phone charging system may not support certain smart phones, which are not verified for the Qi specification (Qi).**
- **When placing your smart phone on the charging pad, position the phone in the middle of the mat for optimal charging performance. If your smart phone is off to the side, the charging rate may be less and in some cases the smart phone may experience higher heat conduction.**
- **In some cases, the wireless charging may stop temporarily when the smart key is used, either when starting the vehicle or locking/unlocking the doors, etc.**

- When charging certain smart phones, the charging indicator may not change to blue when the smart phone is fully charged.
- The wireless charging process may temporarily stop, when temperature abnormally increases inside the wireless smart phone charging system. The wireless charging process restarts, when temperature falls to a certain level.
- The wireless charging process may temporarily stop when there is any metallic item, such as a coin, between the wireless smart phone charging system and smart phone.
- When charging some smart phones with a self-protection feature, the wireless charging speed may decrease and the wireless charging may stop.
- If the smart phone has a thick cover, the wireless charging may not be possible.
- If the smart phone is not completely contacting the charging pad, wireless charging may not operate properly.
- Some magnetic items like credit cards, phone cards or rail tickets may be damaged if left with the smart phone during the charging process.
- When any smart phone without a wireless charging function or a metallic object is placed on the charging pad, a small noise may sound. This small sound is due to the vehicle discerning compatibility of the object placed on the charging pad. It does not affect your vehicle or the smart phone in any way.

Information

This device complies with Part 15 of the FCC rules.

Operation is subject to the following three conditions:

1. This device may not cause harmful interference.
2. This device must accept any interference received, including interference that may cause undesired operation.
3. Changes or modifications not expressly approved by the party responsible for compliance could void the user's authority to operate the device

Information

If the Start/Stop button is in the OFF position, the charging also stops.

Cluster Fascia Side Panel



The cluster fascia side panel is a pad to attach light items such as parking tickets, receipts, etc., using its magnetic surface.

NOTICE

Do not attach heavy items such as cellular phones. Dropping while driving, the items can be damaged.



WARNING

Do not attach the cellular phones and heavy or sharp items to the cluster fascia side panel for safety reason.

This could result in loss of control, and an accident causing death, serious injury, or property damage.

Vehicle to Load (V2L) (if equipped)



V2L (Vehicle to Load) is installed at the central rear seat. V2L is a convenient feature which provides enough electricity to use diverse household electrical appliances in the vehicle.

V2L is installed at the central rear seat bottom.

For more details, refer to “Vehicle to load(V2L)” section in chapter 1.

Clock

The clock can be set from the infotainment system.

For detailed information, refer to the separately supplied infotainment system manual.



WARNING

Do not attempt to adjust the clock while driving. Doing so may result in distracted driving which may lead to an accident involving personal injury or death.

Coat Hook

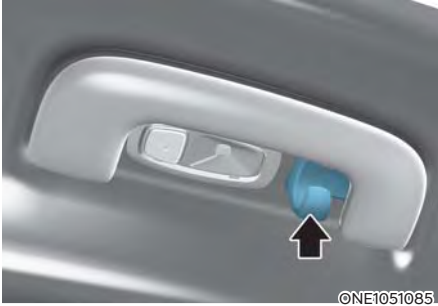

These hooks are not designed to hold large or heavy items.

WARNING



Do not hang other objects such as hangers or hard objects except clothes. Also, do not put heavy, sharp or breakable objects in the clothes pockets. In an accident or when the curtain air bag is inflated, it may cause vehicle damage or personal injury.

Floor Mat Anchor(s)

ALWAYS use the Floor Mat Anchors to attach the front floor mats to the vehicle. The anchors on the front floor carpet keep the floor mats from sliding forward.

WARNING

Do not overlay additional mats or liners over the floor mats. If using All Weather mats, remove the carpeted floor mats before installing them. Only use floor mats designed to connect to the anchors.

WARNING

The following must be observed when installing ANY floor mat to the vehicle.

- Ensure to remove a protective film attached on the carpet before attaching a floor mat on the front floor carpet. Otherwise, the floor mat may move freely on the protective film and it could result in unintentional braking or accelerating.
- Ensure that the floor mats are securely attached to the vehicle's floor mat anchor(s) before driving the vehicle.
- Do not use ANY floor mat that cannot be firmly attached to the vehicle's floor mat anchors.
- Do not stack floor mats on top of one another (for example, all-weather rubber mat on top of a carpeted floor mat). Only a single floor mat should be installed in each position.

IMPORTANT Your vehicle was manufactured with driver's side floor mat anchors that are designed to securely hold the floor mat in place. To avoid any interference with pedal operation, HYUNDAI Vehicle recommends that the HYUNDAI floor mat designed for use in your vehicle be installed.

Rear Side Window Sunshades (if equipped)

Use the rear side window sunshade to block external light coming through the rear window glass.

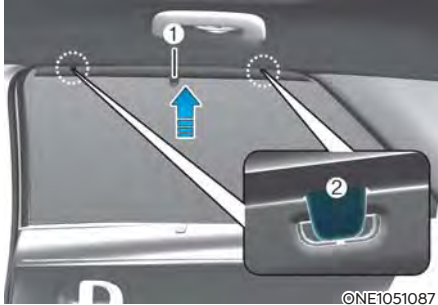

1. Lift the sunshade by the handle (1).
2. Hang the sunshade on both sides of the hook (2). If the sunshade is hung on one side of the hook, the sunshade may be wrinkled.

NOTICE

- Do not hang any other object except the rear side window sunshade on the hooks.
- If you pull the rear side window sunshade or apply force to return the sunshade to its original position after use, you may find the sunshade wrinkled or out of shape. To lower the sunshade, be sure to put the handle downward and slowly return the sunshade to its original position.
- Sunshades may not work properly if foreign objects (coins, toys, cookies, etc.) are stuck in the door. Be careful that the foreign objects do not get into the door.

Luggage Net Holder (if equipped)



To keep items from shifting in the luggage compartment, you can use the 4 holders located in the luggage board to attach the luggage net.

Make sure the luggage net is securely attached to the holders in the luggage board.

If necessary, contact your authorized HYUNDAI dealer to obtain a luggage net.



WARNING

Avoid eye injury. **DO NOT** overstretch the luggage net. **ALWAYS** keep your face and body out of the luggage net's recoil path. **DO NOT** use the luggage net when the strap has visible signs of wear or damage.

Use the luggage net to keep only light items from shifting in the luggage compartment.

Cargo Security Screen (if equipped)

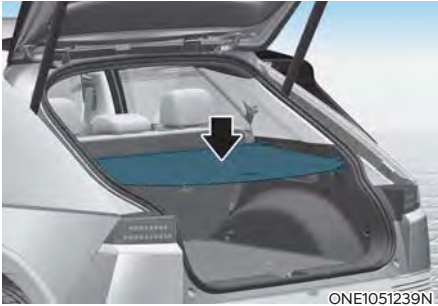

Use the cargo security screen to cover items stored in the cargo area.

Using the cargo security screen

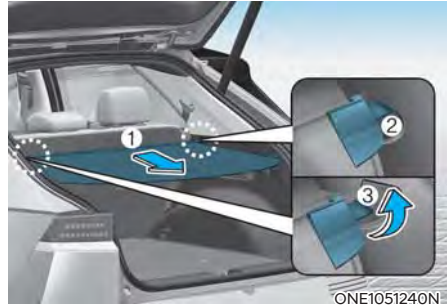

1. Pull the cargo security screen towards the rear of the vehicle by the handle (1).
2. Insert the guide pin (2) into the guide (3).

i Information

Pull out the cargo security screen with the handle in the center to prevent the guide pin from falling out of the guide.

When the cargo security screen is not in use:

1. Pull the cargo security screen rearward and down to release it from the guides.
2. The cargo security screen will automatically slide back in.

i Information

The cargo security screen may not automatically slide back in if the cargo security screen is not fully pulled out. Pull the cargo screen out all the way and then slowly allow the screen to retract back in.

NOTICE

- Since the cargo security screen may be damaged or malformed, do not put luggage on it when it is used.
- The cargo security screen and rear seat may be damaged when the rear seat slides forward/rearward or when the rear seatback is reclined.
- Note that if you release the handle while pulling the luggage screen handle all the way, the screen may wind up quickly and be damaged.

**WARNING**

- Do not place objects on the cargo security screen. Such objects may be thrown about inside the vehicle and possibly injure vehicle occupants during an accident or when braking.
- Never allow anyone to ride in the luggage compartment. It is designed for luggage only.
- Maintain the balance of the vehicle and locate the weight as forward as possible.

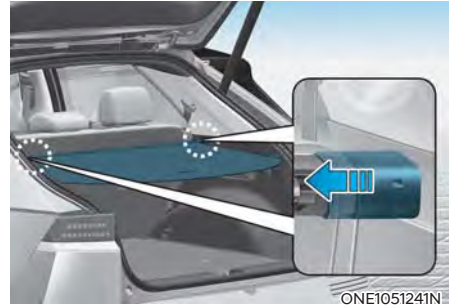
Removing the cargo security screen

1. Push one side of the cargo screen inward to compress the spring and release the screen from the vehicle.
2. While the spring is compressed, pull out the cargo security screen.

INFOTAINMENT SYSTEM

NOTICE

- If you install an aftermarket HID head lamp, your vehicle's audio and electronic devices may not function properly.
- Prevent chemicals such as perfume, cosmetic oil, sun cream, hand cleaner, and air freshener from contacting the interior parts because they may cause damage or discoloration.

USB Port



You can use a USB cable to connect audio devices to the vehicle USB port.

i Information

When using a portable audio device connected to the power outlet, noise may occur during playback. If this happens, use the portable audio device's power source.

Antenna



The shark fin antenna will receive AM, FM broadcast signals and transmit data.

Steering Wheel Remote Controls



NOTICE

Do not operate multiple audio remote control buttons simultaneously.

VOLUME (VOL + / VOL -) (1)

- Rotate the VOLUME scroll up to increase volume.
- Rotate the VOLUME scroll down to decrease volume.

SEEK/PRESET (^ / v) (2)

If the SEEK/PRESET switch is pressed up or down and held for 0.8 second or more, it will function in the following modes:

- **RADIO mode**
It will function as the AUTO SEEK select button. It will SEEK until you release the button.
- **MEDIA mode**
It will function as the FF/RW button.

If the SEEK/PRESET switch is pressed up or down, it will function in the following modes:

- **RADIO mode**
It will function as the PRESET STATION UP/DOWN button.
- **MEDIA mode**
It will function as the TRACK UP/DOWN button.

MODE (3)

Press the MODE button to toggle through Radio or AUX modes.

MUTE (M) (4)

- Press the MUTE(M) button to mute or activate the sound.

For detailed information, refer to the separately supplied infotainment system manual.

Infotainment System

For detailed information, refer to the separately supplied infotainment system manual.

Voice Recognition



For detailed information, refer to the separately supplied infotainment system manual.

Bluetooth® Wireless Technology

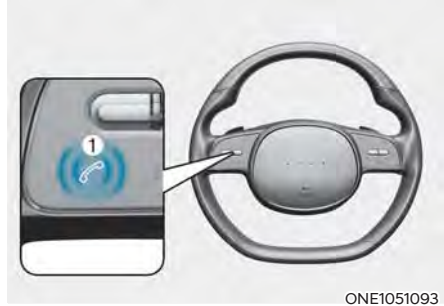

- (1) Call / Answer / Call end button
- (2) Microphone

For detailed information, refer to the separately supplied infotainment system manual.

CAUTION

To avoid driver distractions, do not excessively operate the device while driving the vehicle which may lead to an accident.

6. Driving Your Vehicle

Before Driving	6-3
Before Entering the Vehicle.....	6-3
Before Starting	6-3
Start/Stop Button.....	6-4
Start/Stop Button Positions.....	6-5
Starting the Vehicle.....	6-6
Turning Off the Vehicle	6-7
Remote Start.....	6-8
Transmission (Reduction Gear).....	6-9
Rotary Shifter Operation.....	6-9
LCD Display Messages (Cluster).....	6-13
Good Driving Practices	6-15
Regenerative Braking System	6-16
One Pedal Driving.....	6-17
i-Pedal	6-18
Smart Recuperation System	6-19
Smart Recuperation System Setting.....	6-19
To Activate Smart Recuperation System	6-19
Ready to Operate	6-20
How to Operate	6-21
Smart Recuperation System Will Be Temporarily Cancelled When:.....	6-21
To Resume Smart Recuperation System	6-21
Vehicle-to-Vehicle Distance Recognition Sensor (Front Radar)	6-22
System Malfunction	6-23
Limitations of the System	6-23
Braking System	6-26
Power-Assist Brakes.....	6-26
Disc Brakes Wear Indicator.....	6-27
Electronic Parking Brake (EPB).....	6-27
Auto Hold	6-32
Anti-Lock Brake System (ABS).....	6-35
Electronic Stability Control (ESC)	6-37
Vehicle Stability Management (VSM)	6-40
Hill-Start Assist Control (HAC).....	6-41
Good Braking Practices	6-42

- All Wheel Drive (AWD) 6-43
 - Emergency Precautions..... 6-45
- Drive Mode Integrated Control System (2WD) 6-47
 - Drive Mode 6-47
- Drive Mode Integrated Control System (AWD)..... 6-49
 - Drive Mode 6-49
 - Drive Modes Characteristic 6-51
- Active Air Flap 6-52
 - Malfunction 6-52
- Special Driving Conditions 6-53
 - Hazardous Driving Conditions 6-53
 - Rocking the Vehicle 6-53
 - Smooth Cornering 6-54
 - Driving at Night 6-54
 - Driving in the Rain..... 6-54
 - Driving in Flooded Areas..... 6-55
 - Highway Driving 6-55
 - Reducing the Risk of a Rollover 6-56
- Winter Driving 6-57
 - Snow or Icy Conditions 6-57
 - Winter Precautions..... 6-60
- Vehicle Load Limit 6-61
 - The Loading Information Label 6-62
- Trailer Towing 6-68
 - If You Decide to Pull a Trailer..... 6-68
 - Trailer Towing Equipment 6-71
 - Driving with a Trailer 6-72
 - Maintenance when Towing a Trailer 6-75
- Vehicle Weight 6-76
 - Overloading 6-76

BEFORE DRIVING



WARNING

CALIFORNIA PROPOSITION 65 WARNING

Engine exhaust and a wide variety of automobile components including components found in the interior furnishings in a vehicle, contain or emit harmful chemicals known to the State of California to cause cancer and birth defects and reproductive harm. In addition, certain fluids contained in vehicles and certain products of components contain or emit chemicals known to the State of California to cause cancer and birth defects or other reproductive harm.

Before Entering the Vehicle

- Be sure all windows, outside mirror(s), and outside lights are clean and unobstructed.
- Remove frost, snow, or ice.
- Visually check the tires for uneven wear and damage.
- Check under the vehicle for any sign of leaks.
- Be sure there are no obstacles behind you if you intend to back up.

Before Starting

- Make sure the hood, the liftgate, and the doors are securely closed and locked.
- Adjust the position of the seat and steering wheel.
- Adjust the inside and side view mirrors.
- Verify all the lights work.
- Fasten your seat belt. Check that all passengers have fastened their seat belts.
- Check the gauges and indicators in the instrument panel and the messages on the instrument display when the vehicle is in the ON position.

- Check that any items you are carrying are stored properly or fastened down securely.



WARNING

To reduce the risk of **SERIOUS INJURY** or **DEATH**, take the following precautions:

- **ALWAYS** wear your seat belt. All passengers must be properly belted whenever the vehicle is moving. For more information, refer to “Seat Belts” section in chapter 3.
- Always drive defensively. Assume other drivers or pedestrians may be careless and make mistakes.
- Stay focused on the task of driving. Driver distraction can cause accidents.
- Leave plenty of space between you and the vehicle in front of you.



WARNING

NEVER drink or take drugs and drive.

Drinking or taking drugs and driving is dangerous and may result in an accident and **SERIOUS INJURY** or **DEATH**.

Drunk driving is the number one contributor to the highway death toll each year. Even a small amount of alcohol will affect your reflexes, perceptions and judgment. Just one drink can reduce your ability to respond to changing conditions and emergencies and your reaction time gets worse with each additional drink.

Driving while under the influence of drugs is as dangerous or more dangerous than driving under the influence of alcohol.

You are much more likely to have a serious accident if you drink or take drugs and drive. If you are drinking or taking drugs, don't drive. Do not ride with a driver who has been drinking or taking drugs. Choose a designated driver or call a taxi.

START/STOP BUTTON



Whenever the front door is opened, the Start/Stop button will illuminate and will go off 30 seconds after the door is closed.



WARNING

To turn the vehicle off in an emergency: Press and hold the Start/Stop button for more than two seconds OR Rapidly press and release the Start/Stop button three times (within three seconds).

If the vehicle is still moving, you can restart the vehicle without depressing the brake pedal by pressing the Start/Stop button with the gear in the N (Neutral) position.



WARNING

- **NEVER** press the Start/Stop button while the vehicle is in motion except in an emergency. This will result in the vehicle turning off and loss of power assist for the steering and brake systems. This may lead to loss of directional control and braking function, which could cause an accident.
- Before leaving the driver's seat, always make sure the gear is in the P (Park) position, set the parking brake, press the Start/Stop button to the OFF position, and take the Smart Key with you. Unexpected vehicle movement may occur if these precautions are not followed.
- **NEVER** reach through the steering wheel for the Start/Stop button or any other control while the vehicle is in motion. The presence of your hand or arm in this area may cause a loss of vehicle control resulting in an accident.

Start/Stop Button Positions

Button Position	Action	Notes
OFF	To turn off the vehicle, press the Start/Stop button with the vehicle shifted to P (Park). If the Start/Stop button is pressed with the vehicle shifted to D (Drive), R (Reverse) or N (Neutral), the gear automatically shifts to P (Park).	If the steering wheel is not locked properly when you open the driver's door, the warning chime will sound.
ACC	Press the Start/Stop button when the button is in the OFF position without depressing the brake pedal. Some of the electrical accessories are usable. The steering wheel unlocks.	<ul style="list-style-type: none"> • If you leave the Start/Stop button in the ACC position for more than one hour, the battery power will turn off automatically to prevent the battery from discharging. • If the steering wheel doesn't unlock properly, the Start/Stop button will not work. Press the Start/Stop button while turning the steering wheel right and left to release.
ON	Press the Start/Stop button while it is in the ACC position without depressing the brake pedal. The warning lights can be checked before the vehicle is started.	Do not leave the Start/Stop button in the ON position when the vehicle is not running to prevent the battery from discharging.
START	To start the vehicle, depress the brake pedal and press the Start/Stop button with the gear shifted to the P (Park) position.	If you press the Start/Stop button without depressing the brake pedal, the vehicle does not start and the Start/Stop button changes as follows: OFF → ACC → ON → OFF or ACC

* To prevent vehicle battery discharge, the Start/Stop button changes to the OFF position when the Start/Stop button is in the ACC or ON position with the gear in P (Park) for a certain period of time. When the function operates, the tail lamps will turn off. To use the tail lamps again, turn the headlight switch located on the steering column to the OFF and ON position again.

Starting the Vehicle



WARNING

- Always wear appropriate shoes when operating your vehicle. Unsuitable shoes, such as high heels, ski boots, sandals, flipflops, etc., may interfere with your ability to use the brake and accelerator pedals.
- Do not start the vehicle with the accelerator pedal depressed. The vehicle can move which can lead to an accident.



Information

- The vehicle will start by pressing the Start/Stop button, only when the smart key is in the vehicle.
- Even if the smart key is in the vehicle, and when it is far away from the driver, the vehicle may not start.
- When the Start/Stop button is in the ACC or ON position, if any door is open, the system checks for the smart key. When the smart key is not in the vehicle, the “” indicator will blink and the warning 'Key not in vehicle' will come on. When all doors are closed, the chime will also sound for about 5 seconds. Keep the smart key in the vehicle when in the ACC position or if the vehicle is in the ready (READY) mode.

Starting the vehicle

1. Always carry the smart key with you.
2. Make sure the parking brake is applied.
3. Make sure the gear is in P (Park).
4. Depress the brake pedal.
5. Press the START/STOP button. If the vehicle starts, the "READY" indicator will come on.



Information

- Always start the vehicle with your foot on the brake pedal. Do not depress the accelerator while starting the vehicle. Do not race the motor while warming it up.
- If ambient temperature is low, the “” indicator may remain illuminated longer than the normal amount of time.

NOTICE

To prevent damage to the vehicle:

- If the (READY) indicator turns off while you are in motion, do not attempt to shift the gear to the P (Park) position.

If traffic and road conditions permit, you may put the gear in N (Neutral) while the vehicle is still moving and press the Start/Stop button in an attempt to restart the vehicle.

- Do not push or tow your vehicle to start the vehicle.

NOTICE

To prevent damage to the vehicle:

Do not press the Start/Stop button for more than 10 seconds except when the stop lamp fuse is blown.

When the stop lamp fuse is blown, you cannot normally start the vehicle. Replace the fuse with a new one. If you are not able to replace the fuse, you can start the vehicle by pressing and holding the Start/Stop button for 10 seconds with the Start/Stop button in the ACC position.

Pressing the brake pedal many times while "READY" indicator light is off will increase the possibility of discharging the 12V battery.

For your safety always depress the brake pedal before starting the vehicle.

**Information**

Virtual Engine Sound System(VESS)

VESS generates virtual engine sound to make pedestrians to aware. VESS operates when the vehicle can be driven. When the vehicle in P(parking) gear status, VESS doesn't work.

**CAUTION**

- Because the vehicle doesn't make the engine sound, pay attention to the surrounding environment and drive carefully.
- After parking or waiting for a traffic light, please check around(children, obstacle, etc.) before departure.
- When reversing, check directly behind you before driving. Pedestrians may not be able to recognize vehicle sounds.

Emergency starting

If the smart key battery is weak or the smart key does not work correctly, you can start the vehicle by pressing the Start/Stop button with the smart key in the direction of the picture above.

Turning Off the Vehicle

1. Stop the vehicle and depress the brake pedal fully.
2. Shift to P (Park).
3. Press the Start/Stop button to the OFF position and apply the parking brake.
4. Make sure the 'READY' indicator light is off in the instrument cluster.

**CAUTION**

If the "READY" indicator light on the instrument cluster is still on, the vehicle is not turned off and can move when the gear is in any position except P (Park).

Remote Start

■ Type A



ONE1061047N

■ Type B



ONE1061006

■ Type C



ONE1061048N

■ Type D



ONE1061007

You can start the vehicle using the Remote Start button of the smart key.

To start the vehicle remotely:

1. Press the door lock button within 32 feet (10 m) from the vehicle.
2. Press the remote start (⌚) button for over 2 seconds within 4 seconds after locking the doors.
3. To turn off the remote start function, press the remote start (⌚) button once.

- The remote start (⌚) button may not operate if the smart key is not within 32 feet (10 m).
- The vehicle will not remotely start if the hood or liftgate is opened.
- The vehicle must be in P (Park) for the remote start function to start.
- The vehicle turns off if you get in the vehicle without a registered smart key.
- The vehicle turns off if you do not get in the vehicle within 10 minutes after remotely starting the vehicle.

TRANSMISSION (REDUCTION GEAR)

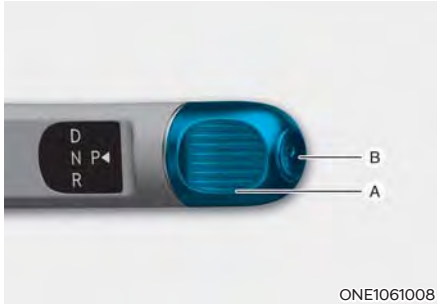

ONE1061008

[A]: Rotary gear shift dial, [B]: P button

Rotary Shifter Operation

To change the gear, depress the brake pedal and rotate the rotary gear shift dial.



WARNING

To reduce the risk of serious injury or death:

- **ALWAYS** check the surrounding areas near your vehicle for people, especially children, before shifting a vehicle into D (Drive) or R (Reverse).
- Before leaving the driver's seat, always make sure the vehicle is shifted to the P (Park) position, then apply the parking brake, then press the Start/Stop button to the OFF position. Unexpected and sudden vehicle movement can occur if these precautions are not followed.

Rotary shifter/ Rotary gear shift dial

P (Park)

Always come to a complete stop before shifting into P (Park).



ONE1061001

To shift the gear to P (Park), press the P button while depressing the brake pedal. If you turn the vehicle off in R (Reverse), N (Neutral) or D (Drive), the gear will automatically shift to P (Park).



WARNING

- Shifting into P (Park) while the vehicle is in motion may cause you to lose control of the vehicle.
- After the vehicle has stopped, always make sure the vehicle is in P (Park), apply the parking brake, and turn the vehicle off.
- When parking on an incline, shift the gear to P (Park) and apply the parking brake to prevent the vehicle from rolling downhill.



Information

For vehicles equipped with the Electronic Parking Brake (EPB), EPB applies automatically when the gear is shifted to P (Park).

Automatic gear shift to P (Park)

The gear is shifted to P (Park) automatically for safety reasons under the following conditions:

- When the vehicle is turned off with the gear in R (Reverse), D (Drive) or N (Neutral).
- When the driver's door is open with the vehicle running, the gear in R (Reverse), D (Drive) or N (Neutral), and the vehicle at a standstill.
- When the driver's door is open with the gear in N (Neutral) and the vehicle is off.

In situations the gear must be in P (Park), always check if the gear is shifted to P (Park) by checking the cluster.

R (Reverse)

Use this position to drive the vehicle rearward.



To shift the gear to R (Reverse), rotate the rotary gear shift dial to R (Reverse) while depressing the brake pedal.

When the vehicle is stopped in the R (Reverse) position, if you open the driver's door, the gear will automatically shift to P (Park).

However, if the vehicle is in motion, the gear may not automatically shift to P (Park) to prevent reduction gear damage. The direction of the rotary gear shift dial is the same as that of the wheel.

NOTICE

Always come to a complete stop before shifting into or out of R (Reverse); you may damage the reduction gear if you shift into R (Reverse) while the vehicle is in motion.

N (Neutral)

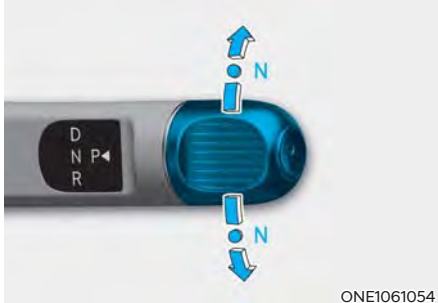

ONE1061054

To shift the gear to N (Neutral), rotate the rotary gear shift dial to N (Neutral) while depressing the brake pedal.

Always depress the brake pedal when you are shifting from N (Neutral) to another gear.

If you turn the vehicle off in N (Neutral), the gear will automatically shift to P (Park).

However, if you need to stay in N (Neutral) with the vehicle off, refer to “To stay in N (Neutral) when vehicle is OFF” in the following description.

To rotate the rotary gear shift dial to N (Neutral), rotate the rotary gear shift dial once clockwise or counterclockwise.

If the current gear position is in D (Drive), rotate the rotary gear shift dial counterclockwise. When the gear position is in R (Reverse), rotate the rotary gear shift dial clockwise.

To stay in N (Neutral) when vehicle is OFF



ONE1061026L



ONE1061011

If you want to stay in N (Neutral) after the vehicle is in the ACC state, do the following.

1. Turn off Auto Hold and release Electronic Parking Brake when the vehicle is running.
2. Rotate the shift to N (neutral) while depressing the brake pedal.
3. When you take your foot off the brake pedal, the message ‘Press and hold OK button Press and hold the OK button on the steering wheel to stay in Neutral will appear on the cluster LCD display.

4. Press and hold the OK button on the steering wheel for more than 1 second.
5. When the message 'Vehicle will stay in (N). Change gear to cancel' (or 'N will stay engaged when the vehicle is Off') will appear on the cluster LCD display, press the Start/Stop button while depressing the brake pedal.

However, if you open the driver's door within 3 minutes in the ACC state, the gear will automatically shift to P (Park) and the Start/Stop button will change to the OFF position.

NOTICE

- **With the gear in N (Neutral) the Start/Stop button will be in the ACC position. Note that the doors cannot be locked in the ACC position or the battery (12V) may discharge if left in the ACC position for a long period.**
- **Before entering an automatic car wash, release the Electronic Parking Brake (EPB) manually. If EPB is applied, it may damage the vehicle or automatic car wash.**

i Information

When the Electronic Parking Brake (EPB) is applied, press the EPB switch while depressing the brake pedal.

The Electronic Parking Brake (EPB) must be released manually because EPB does not release automatically even though the gear is shifted to N (Neutral).

D (Drive)

This is the normal driving position.

The reduction gear automatically activates the regenerative braking system according to the road conditions.

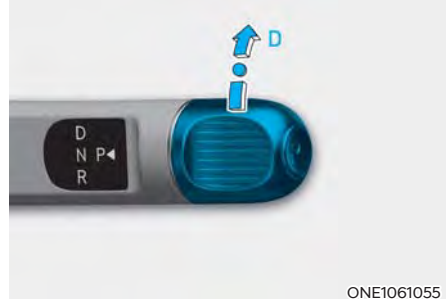

To shift the gear to D (Drive), rotate the rotary gear shift dial to D (Drive) while depressing the brake pedal.

When the vehicle is stopped in the D (Drive) position, if you open the driver's door, the gear will automatically shift to P (Park).

However, if the vehicle is in motion, the gear may not automatically shift to P (Park) to prevent reduction gear damage.

NOTICE

Always come to a complete stop before shifting into D (Drive).



CAUTION

When you start after stopping on a steep incline, even if the gear is in D (Drive), if you do not depress the accelerator or brake pedal, the vehicle may roll backwards, which can cause an accident.

When the battery (12V) is discharged

You cannot shift gears, when the battery is discharged.

Jump start your vehicle (refer to "Jump Starting" in chapter 8) or contact an authorized HYUNDAI dealer.

Parking

Always come to a complete stop and continue to depress the brake pedal. Shift the gear to P (Park), apply the parking brake, and press the Start/Stop button to the OFF position. Take the Key with you when leaving the vehicle.

LCD Display Messages (Cluster)**Press brake pedal to change gear**

This message is displayed when the brake pedal is not depressed while shifting the gear.

Depress the brake pedal and then shift the gear.

Shift to P after stopping

This message is displayed when the gear is shifted to P (Park) while the vehicle is moving.

Stop the vehicle before shifting to P (Park).

Shifter system malfunction



This message is displayed when the shift gear does not properly operate in the P (Park) position.

Have the vehicle inspected by an authorized HYUNDAI dealer.

Check shifter dial



This message is displayed when there is a malfunction with the rotary gear shift dial.

Have the vehicle inspected by an authorized HYUNDAI dealer.

Check P button



This message is displayed when there is a problem with the P button.

Have the vehicle inspected by an authorized HYUNDAI dealer.

Rotary shifter stuck

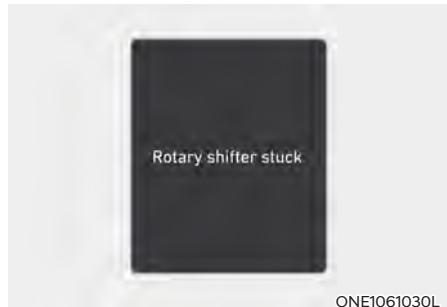

This message is displayed when the rotary gear shift dial does not return back to its normal position after rotating it.

Have the vehicle inspected by an authorized HYUNDAI dealer.

Good Driving Practices

- Never shift the gear from P (Park) or N (Neutral) to any other position with the accelerator pedal depressed.
- Never shift the gear into P (Park) when the vehicle is in motion.

Be sure the vehicle is completely stopped before you attempt to shift into R (Reverse) or D (Drive).

- Do not shift the gear to N (Neutral) when driving. If the gear is shifted to N (Neutral) while driving. Doing so may increase the risk of an accident. Also, shift the gear back to D (Drive) while the vehicle is moving may severely damage the reduction gear.
- When driving uphill or downhill, always shift to D (Drive) for driving forward or shift to R (Reverse) for driving rearwards. After selecting D (Drive) or R (Reverse), check the gear position indicated on the cluster before driving. If the vehicle moves in the opposite direction of the selected gear, the vehicle may turn off and a serious accident might occur due to degraded brake performance.
- Do not drive with your foot resting on the brake pedal. Even light, but consistent pedal pressure can result in the brakes overheating, brake wear and possibly even brake failure.
- Always apply the parking brake when leaving the vehicle. Do not depend on placing the shift gear in P (Park) to keep the vehicle from moving.
- Exercise extreme caution when driving on a slippery surface. Be especially careful when braking, accelerating or shifting gears. On a slippery surface, an abrupt change in vehicle speed can cause the drive wheels to lose traction and may cause loss of vehicle control resulting in an accident.

- Optimum vehicle performance and economy is obtained by smoothly depressing and releasing the accelerator.



WARNING

To reduce the risk of **SERIOUS INJURY** or **DEATH**:

- **ALWAYS wear your seat belt. In a collision, an unbelted occupant is significantly more likely to be seriously injured or killed than a properly belted occupant.**
- **Avoid high speeds when cornering or turning.**
- **Do not make quick steering wheel movements, such as sharp lane changes or fast, sharp turns.**
- **The risk of rollover is greatly increased if you lose control of your vehicle at highway speeds.**
- **Loss of control often occurs if two or more wheels drop off the roadway and the driver over steers to reenter the roadway.**
- **In the event your vehicle leaves the roadway, do not steer sharply. Instead, slow down before pulling back into the travel lanes.**
- **HYUNDAI Vehicle recommends you to follow all posted speed limits.**

REGENERATIVE BRAKING SYSTEM

Regenerative braking (Paddle shifter)

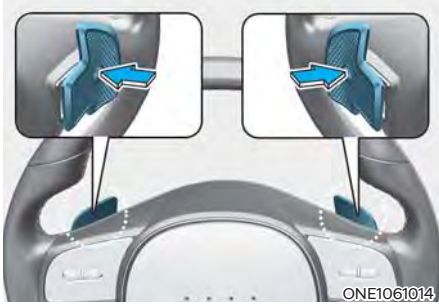

The paddle shifter is used to adjust the regenerative braking level from 0 to 3 during decelerating.

- Left side (+



Refer to the following pages on "One pedal driving".

- Pull and hold the right side paddle shifter for over 1 second to turn on and off the automatic change of the regenerative braking.

Refer to the following pages on "Smart Recuperation System".

Information

The paddle shifter does not operate when:

- The [] and [] paddle shifters are pulled at the same time.
- The vehicle is decelerating by depressing the brake pedal.
- The Cruise Control system or Smart Cruise Control system is activated.
- Selecting 0 step of the regenerative braking system, the brake disc cleaning function is operated around 10 times. While operating to clean the brake disc, the driving distance and the regenerative braking performance can be reduced. After finishing, the regenerative braking performance will be restored.

Information

2WD Long Range vehicles default to level 3 regenerative braking whenever the vehicle is turned on.

Information

The regenerative braking system on 2WD Long Range vehicles defaults to Level 3 (L3) in order to maximize vehicle's all electric range. This setting will default to Level 3 (L3) whenever the vehicle is turned ON. Driver is able to adjust the regenerative system to their preference after each vehicle start, but it will only remain until the vehicle is shut down.



ONE1061036

The selected regenerative braking level is displayed on the instrument cluster.

Initial setting of the regenerative braking level and adjustable range vary according to the selected Drive mode.

Drive mode	Adjustable Range
SNOW	0 to 1
ECO	0 to 3
NORMAL	0 to 3
SPORT	0 to 3

For more details, refer to "Drive Mode Integrated Control System" in this chapter.

One Pedal Driving

The driver can stop the vehicle by pulling the left side paddle shifter .

To operate:

- Pull and hold the left side paddle shifter while coasting.
- When the vehicle speed is above 1.8 mph (3 km/h), release the paddle shifter to return to the preset regenerative braking stage.
- When the vehicle speed is below 1.8 mph (3 km/h), the function maintains control to stop the vehicle even though the paddle shifter is released.
- While the One pedal driving is operating, the driver can control the vehicle stopping position using the accelerator pedal.

Limitations

The vehicle may move even if one pedal driving is normally operated. Therefore, the driver should be careful to stop the vehicle by this function under circumstances as follows:

- Driving on icy, snowy, wet, sandy, muddy roads, manhole/pit hole surfaces
- Wheels not aligned
- Conditions in which wheel slip or spin occurs
- On heavy loading
- By leaning left of right
- Under bad tire wear
- Driving uphill or downhill
- Driving where the slope starts or ends
- By repeating stop and go on ramp

Automatic engagement of EPB

After the vehicle is stopped by the One Pedal Driving function, EPB is automatically engaged when any of these conditions occur:

- The driver's seatbelt is unfastened and the driver's door is open.
- The hood is open.
- The liftgate is open.
- 5 minutes have passed after the vehicle has stopped.
- The system operation is limited due to other reasons.



WARNING

- **Stopping the vehicle may not be possible according to the vehicle and road conditions. Pay attention to the road condition ahead and apply the brake if necessary.**
- **Please refrain to use the one pedal driving function with the road conditions are bad such as being wet, iced or covered with snow.**



CAUTION

When the vehicle is stopped or parked by One Pedal Driving on the steep hills, be sure to depress the brake pedal.

i-Pedal

i-Pedal is controlled by acceleration pedal. i-Pedal provides vehicle speed control (acceleration/deceleration, stopping) without manually controlling the paddle shifter.

To operate:

- Pull the left side paddle shifter at level 3 regenerative braking system.
- During the activation of i-Pedal, the vehicle is stopped when the vehicle speed is less than 1 mph (3 km/h) even if the brake pedal is not pressed.
- When you press the accelerator pedal at the same time during one-pedal driving by pulling the left paddle shift lever, the vehicle cannot be stopped.



CAUTION

When the vehicle is stopped or parked by i-Pedal on the steep hills, be sure to depress the brake pedal.

To deactivate:

- The i-Pedal is deactivated when the driver turns off the vehicle. When the vehicle is turned on, the regenerative braking is set to be on level 3.
- The i-Pedal is turned off and the regenerative braking changes to level 3 when the gear is shifted to R.

Limitations

The vehicle may move even if one pedal driving is normally operated. Therefore, the driver should be careful to stop the vehicle by this function under circumstances as follows:

- Driving on icy, snowy, wet, sandy, muddy roads, manhole/pit hole surfaces
- Wheels not aligned
- Conditions in which wheel slip or spin occurs
- On heavy loading
- By leaning left of right
- Under bad tire wear
- Driving uphill or downhill
- Driving where the slope starts or ends
- By repeating stop and go on ramp

SMART RECUPERATION SYSTEM

The Smart Recuperation System controls the regenerative braking automatically according to the road gradient and driving condition of the vehicle in front. The system minimizes the unnecessary operation of the brake and acceleration pedal, improving the electric energy efficiency and assisting the driver.

Smart Recuperation System Setting

Pull and hold the right side paddle shifter for over 1 second to turn on and off the automatic change of the regenerative braking.

To Activate Smart Recuperation System



When Smart Recuperation System is On in the infotainment system, 'AUTO' for the regenerative braking level is displayed on the cluster. The regenerative braking level is controlled automatically when vehicle speed is above 6 mph (10 km/h) and one of the condition below is met.

- The road gradient changes
- Distance from the vehicle ahead reduces or increases
- Speed of the vehicle ahead reduces or increases

Information

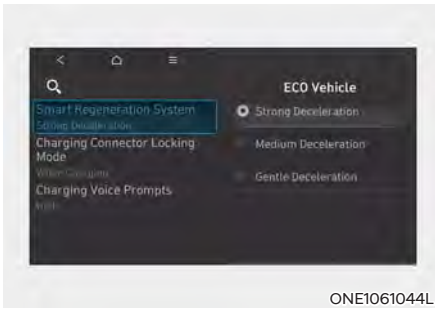

The regenerative braking level can be adjusted based on the driver's deceleration style (strong/medium/gentle)

To adjust the level, select 'Settings → ECO vehicle → Smart Regeneration System' in the infotainment system.

WARNING

When vehicle speed is under 6 mph (10 km/h), the Smart Recuperation System is cancelled. The driver must adjust the vehicle speed by depressing the accelerator or brake pedal according to the road condition ahead and driving condition.

Smart Recuperation System relies on front view camera in the vehicle. Foreign substances on the front view camera may cause the malfunction of Smart Recuperation System. Be sure to maintain clear view for the front view camera.

The Smart Recuperation System will not operate when the Forward Collision-Avoidance Assist (FCA) system warning light illuminates on the cluster. The driver must adjust the vehicle speed by depressing the accelerator or brake pedal according to the road condition ahead and driving condition.

Ready to Operate



Regenerative braking level is displayed on cluster.

How to Operate



ONE1041017

Pulling the paddle-shift () for 1 or more seconds, the smart recuperation system will operate. The indicator of the regenerative braking will be changed to 'AUTO' from the level indicator.



WARNING

The Smart Recuperation System which automatically controls the regenerative braking level when coasting is only a supplemental system for the driver's convenience. The system cannot completely stop the vehicle nor avoid all collisions. The brake control may be insufficient depending on the speed of the vehicle in front and when the vehicle in front suddenly stops, a vehicle cuts in suddenly and there is a steep slope. Always look ahead cautiously to prevent unexpected and sudden situations from occurring.

Smart Recuperation System Will Be Temporarily Cancelled When:

- Cancelled manually
 - Pulling and holding the right side paddle shifter for more than 1 second. The Smart Recuperation System turns off temporarily and "AUTO" will be replaced with regenerative braking level indicator.
- Cancelled automatically
 - The vehicle is shifted to N (Neutral), R (Reverse) or P (Park).
 - Cruise Control system (including Smart Cruise Control system) is in activation.
 - The ESC (Electronic Stability Control) or ABS is operating.



WARNING

When the Smart Recuperation System is cancelled automatically, adjust the vehicle speed directly by depressing the accelerator or brake pedal according to the road condition ahead and driving condition.

To Resume Smart Recuperation System

To re-activate the Smart Recuperation System while driving, pull and hold the right side paddle shifter for more than 1 second again. Then, AUTO for the regenerative braking level will appear on the cluster.

Vehicle-to-Vehicle Distance Recognition Sensor (Front Radar)



[1] : Front radar
For detail location of sensor, refer to the picture above.

In order for the Smart Recuperation System to operate properly, always make sure the radar sensor cover is clean and free of dirt, snow, and debris. Dirt, snow, or foreign substances on the lens may adversely affect the sensing performance of the sensor. In this case, the system operation may stop temporarily and not operate normally.

CAUTION

- Do not apply license plate frame or foreign objects such as a bumper sticker or a bumper guard near the radar sensor. Doing so may adversely affect the sensing performance of the radar.
- Always keep the radar sensor and lens cover clean and free of dirt and debris.
- Use only a soft cloth to wash the vehicle. Do not spray pressurized water directly on the sensor or sensor cover.
- Be careful not to apply unnecessary force on the radar sensor or sensor cover. If the sensor is forcibly moved out of proper alignment, the Smart Recuperation System may not operate correctly. In this case, a warning message may not be displayed. Have the vehicle inspected by an authorized HYUNDAI dealer.
- If the front bumper becomes damaged in the area around the radar sensor, the Smart Recuperation System may not operate properly. Have the vehicle authorized HYUNDAI dealer.
- Use only genuine parts or the equivalent specified for your vehicle to repair or replace a damaged sensor or sensor cover. Do not apply paint to the sensor cover.

System Malfunction



Check smart recuperation system

The message will appear when the system is not functioning normally. The system will be cancelled and the word 'AUTO' on the cluster will disappear and instead display regenerative braking level. Check for foreign substances on the front radar. Remove any dirt, snow, or foreign material that could interfere with the radar sensors. If the system still does not operate normally, take your vehicle to an authorized HYUNDAI dealer and have the system checked.

Limitations of the System

The Smart Recuperation System may not operate properly in certain situations when the driving condition is beyond the performance of the front radar sensor. Driver's attention is required in such cases when the system does not react properly or operate unintentionally.

On curves



When coasting on the curve, the system may not detect the vehicle in your lane and the regenerative braking level will reduce automatically, making you feel that the vehicle is accelerating.

Also, if the system suddenly recognizes the vehicle in front, the regenerative braking level will increase automatically, making you feel that the vehicle is decelerating.

The driver must maintain a safe braking distance, and if necessary, depress the brake pedal to reduce your driving speed in order to maintain a safe distance.



Your vehicle speed can be reduced due to a vehicle in the adjacent lane.

Apply the accelerator pedal and select the appropriate speed. Check to be sure that the road conditions permit safe operation of the Smart Recuperation System.

On inclines

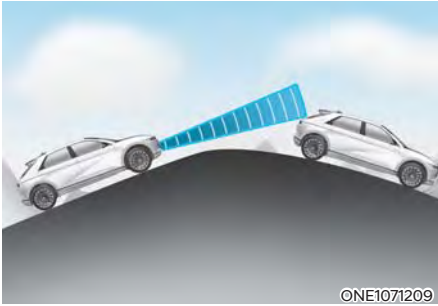

When coasting on an uphill or downhill, the system may not detect the vehicle in your lane and the regenerative braking level will reduce automatically, making you feel that the vehicle is accelerating. Also, if the system suddenly recognizes the vehicle in front, the regenerative braking level will increase automatically, making you feel that the vehicle is decelerating.

The driver must maintain a safe braking distance, and if necessary, depress the brake pedal to reduce your driving speed in order to maintain a safe distance.

Lane changing

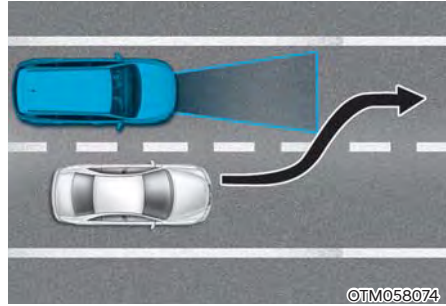

- A vehicle which moves into your lane from an adjacent lane cannot be recognized by the sensor until it is in the sensor's detection range.
- The radar may not detect immediately when a vehicle cuts in suddenly. Always pay attention to the traffic, road and driving conditions.

Vehicle recognition

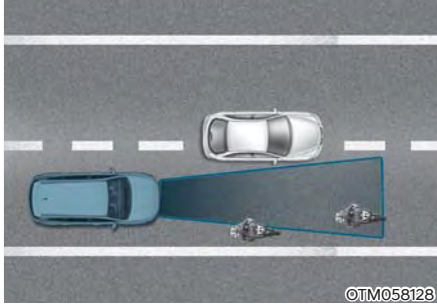

Some vehicles in your lane cannot be recognized by the sensor:

- Narrow vehicles such as motorcycles or bicycles
- Vehicles offset to one side
- Slow-moving vehicles or sudden-decelerating vehicles
- Stopped vehicles (When the vehicle ahead drives away, the system may not detect a stopped vehicle.)
- Vehicles with small rear profile such as trailers with no loads

A vehicle ahead cannot be recognized correctly by the sensor if any of following occurs:

- When the vehicle is pointing upwards due to overloading in the luggage compartment.
- While the steering wheel is operating.
- When driving to one side of the lane.
- When driving on narrow lanes or on curves.
- Apply the brake or accelerator pedal if necessary.



WARNING

When using the Smart Recuperation System take the following precautions:

- If an emergency stop is necessary, you must apply the brakes.
- Keep a safe distance according to road conditions and vehicle speed. If the vehicle to vehicle distance is too close during a high-speed driving, a serious collision may result.
- Always maintain sufficient braking distance and decelerate your vehicle by applying the brakes if necessary.
- The Smart Recuperation System cannot recognize a stopped vehicle, pedestrians or an oncoming vehicle. Always look ahead cautiously to prevent unexpected and sudden situations from occurring.
- Vehicles moving in front of you with a frequent lane changes may cause a delay in the system's reaction or may cause the system to react to a vehicle actually in an adjacent lane. Always drive cautiously to prevent unexpected and sudden situations from occurring.
- The Smart Recuperation System may not recognize complex driving situations so always pay attention to driving conditions and control your vehicle speed.

NOTICE

The Smart Recuperation System may not operate temporarily due to:

- Electrical interference
- Modifying the suspension
- Differences of tire abrasion or tire pressure
- Installing different type of tires

BRAKING SYSTEM

Power-Assist Brakes

Your vehicle has power-assisted brakes that adjust automatically through normal usage.

In the event of a vehicle power failure, the power assist for the brakes will not work. You can still stop your vehicle, but it will require greater force and increased pedal travel than normal. The stopping distance, however, will be longer than with power brakes.

Information

- When the brake pedal is depressed under certain driving conditions or weather conditions, you may temporarily hear a noise. This is normal and does not indicate a problem with your brakes.
- While driving on a road with deicing chemicals, brake noise or abnormal tire wear may occur due to deicing chemicals. In a safe traffic condition, additionally apply the brakes to remove deicing chemicals on the brake discs and pads.

WARNING

Take the following precautions:

- Do not drive with your foot resting on the brake pedal. This will create abnormal high brake temperatures, excessive brake lining and pad wear, and increased stopping distances. So increase the regeneration braking level with the left paddle shift lever to decrease the speed.

- When descending down a long or steep hill, use the paddle shifter to increase the regeneration braking level in order to decrease your speed without using the brake pedal excessively. Applying the brakes continuously will cause the brakes to overheat and could result in a temporary loss of braking performance.
- Wet brakes may impair the vehicle's ability to safely decelerate. Because wet brakes increase braking distance and cause noise troubles, select 0 step of the regenerative braking system and depress the brake pedal around 10 times, with keeping the safe distance from other vehicles, lightly in order to dry the braking system. Such procedure may decrease the driving distance by restraining the regenerative braking system, which is not a system malfunction. Inspect the braking system after car wash or driving over wet road conditions.

NOTICE

- Do not continue depressing the brake pedal if the "READY" indicator is OFF. The battery may be discharged.
- Noise and vibration generated during braking is normal.
- Under normal operation, electric brake pump noise and motor vibration may occur temporarily in below cases.
 - When the pedal is depressed suddenly.
 - When the pedal is repeatedly depressed in short intervals.
 - When the ABS function is activated while braking.

Disc Brakes Wear Indicator

When your brake pads are worn and new pads are required, you will hear a high pitched warning sound from your front or rear brakes. You may hear this sound come and go or it may occur whenever you depress the brake pedal.

NOTICE

To avoid costly brake repairs, do not continue to drive with worn brake pads.

i Information

Always replace brake pads as complete front or rear axle sets.

! WARNING

Frequent braking may deform components and worn the disc brake causing vibration when braking. Observe the speed limit to prevent brake damage from excessive braking.

Brake wear, noise, vibration from excessive braking or deformation of the brakes caused by repeatedly braking in high speed, racing on tracks, etc. can be excluded from warranty coverage.

Electronic Parking Brake (EPB)

Applying the parking brake



ONE1061015

To apply EPB (Electronic Parking Brake):

1. Depress and hold the brake pedal.
2. Pull up the EPB switch.

Make sure the Parking Brake warning light comes on.

EPB (Electronic Parking Brake) may be automatically applied when:

- Requested by other systems
- The driver turns the vehicle off while Auto Hold is operating.

Emergency braking

If there is a problem with the brake pedal while driving, emergency braking is possible by pulling up and holding the EPB switch. Braking is possible only while you are holding the EPB switch. However, braking distance will be longer than normal.



WARNING

To reduce the risk of **SERIOUS INJURY** or **DEATH**, do not operate the EPB while the vehicle is moving except in an emergency situation. It could damage the brake system and lead to an accident.



Information

During emergency braking, the Parking Brake warning light will illuminate to indicate that the system is operating.

NOTICE

If you continuously notice a noise or burning smell when the EPB is used for emergency braking, have the system checked by an authorized **HYUNDAI** dealer.

Releasing the parking brake



To release EPB (Electronic Parking Brake):

1. Press the Start/Stop button to the ON or START position.
2. Press the EPB switch while depressing the brake pedal.

Make sure the Parking Brake warning light goes off.

To release EPB (Electronic Parking Brake) automatically:

- Gear in P (Park)
With the vehicle running depress the brake pedal and shift out of P (Park) to R (Reverse) or D (Drive).
- Gear in N (Neutral)
With the vehicle running depress the brake pedal and shift out of N (Neutral) to R (Reverse) or D (Drive).

- Satisfy the following conditions
1. Ensure seat belts are fastened and the doors, hood and liftgate are closed.
 2. With the vehicle running, depress the brake pedal and shift out of P (Park) to R (Reverse), D (Drive) or Manual shift mode.
 3. Depress the accelerator pedal.
Make sure the Parking Brake warning light goes off.

i Information

- **For the Middle East, EPB is released regardless of seat belt fastening.**
- **For your safety, you can engage EPB even though the Vehicle Stop/Start button is in the OFF position (only if battery power is available), but you cannot release it.**
- **For your safety, depress the brake pedal and release the parking brake manually with the EPB switch when you drive downhill or when backing up the vehicle.**

NOTICE

- **If the Parking Brake warning light is still on even though the EPB has been released, have the system checked by an authorized HYUNDAI dealer.**
- **Do not drive your vehicle with EPB applied. It may cause excessive brake pad and brake rotor wear.**

Warning messages

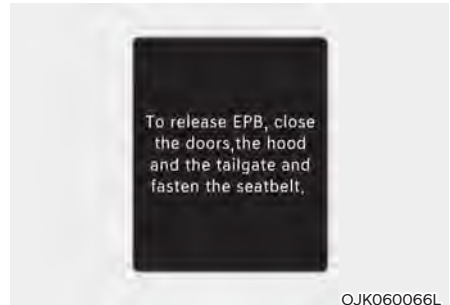

To release EPB, close the doors, hood and liftgate and fasten the seatbelt

- If you try to drive with EPB applied, a warning will sound and a message will appear.
- If the driver's seat belt is unfastened and the hood or liftgate is opened, a warning will sound and a message will appear.
- If there is a problem with the vehicle, a warning may sound and a message may appear.

If the situation occurs, depress the brake pedal and release EPB by pressing the EPB switch.



WARNING

- Whenever leaving the vehicle or parking, always come to a complete stop and continue to depress the brake pedal.

Shift the gear into P (Park), pull the EPB switch, and press the Start/Stop button to the OFF position. Take the Key with you when leaving the vehicle.

Vehicles not fully engaged in P (Park) with the parking brake set are at risk for moving inadvertently and causing injury to yourself or others.

- NEVER allow anyone who is unfamiliar with the vehicle to touch the EPB switch. If EPB is released unintentionally, serious injury may occur.
- Only release EPB when you are seated inside the vehicle with your foot firmly on the brake pedal.



CAUTION

In winter, the Electronic Parking Brake (EPB) related device may freeze and cannot be released. Do not use the Electronic Parking Brake (EPB) but park on a flat surface with the gear in P (Park). Use wheel chocks under the wheels if necessary.

If the Electronic Parking Brake (EPB) applies automatically when the gear is shifted to P (Park), turn off Auto Hold, and press the Electronic Parking Brake (EPB) switch to release the parking brake.

NOTICE

- Do not apply the accelerator pedal while the parking brake is engaged. If you depress the accelerator pedal with EPB engaged, a warning will sound and a message will appear. Damage to the parking brake may occur.
- Driving with the parking brake on can overheat the braking system and cause premature wear or damage to brake parts. Make sure EPB is released and the Parking Brake warning light is off before driving.



Information

- A clicking sound may be heard while operating or releasing the EPB. These conditions are normal and indicate that EPB is functioning properly.
- When leaving your keys with a parking attendant or assistant, make sure to inform him/her how to operate EPB.



AUTO HOLD turning Off! Press brake pedal

When the conversion from Auto Hold to EPB is not working properly a warning will sound and a message will appear.

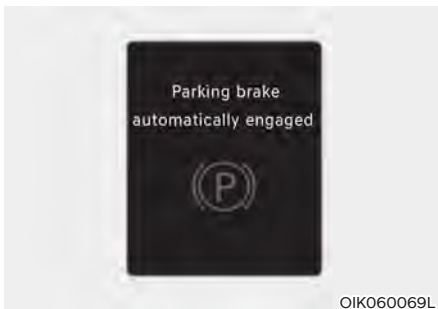

Parking brake automatically engaged

When EPB is applied while Auto Hold is activated, a warning will sound and a message will appear.

EPB malfunction

Electronic Parking Brake (EPB) warning light illuminates if the Start/Stop button is pressed to the ON position and goes off in approximately 3 seconds if the system is operating normally.

If the EPB warning light remains on, comes on while driving, or does not come on when the Start/Stop button is pressed to the ON position, this indicates that the EPB may have malfunctioned.

If this occurs, have the system checked by an authorized HYUNDAI dealer.

The EPB warning light may illuminate when the ESC indicator comes on to indicate that ESC is not working properly, but it does not indicate a malfunction of EPB.

NOTICE

- If the EPB warning light is still on, have the system checked by an authorized HYUNDAI dealer.
- If the Parking Brake warning light does not illuminate or blinks even though the EPB switch was pulled up, EPB may not be applied.
- If the Parking Brake warning light blinks when the EPB warning light is on, press the switch, and then pull it up. Repeat this one more time. If the EPB warning does not go off, have the system checked by an authorized HYUNDAI dealer.

Parking brake warning light

(!)(P) Check the Parking Brake warning light by pressing the Vehicle Stop/Start button to the BRAKE position.

This light will be illuminated when the parking brake is applied with the Vehicle Stop/Start button in the START or ON position.

Before driving, be sure the parking brake is released and the Parking Brake warning light is OFF.

If the Parking Brake warning light remains on after the parking brake is released while the motor is running, there may be a malfunction in the brake system. Immediate attention is necessary.

If at all possible, cease driving the vehicle immediately. If that is not possible, use extreme caution while operating the vehicle and only continue to drive the vehicle until you can reach a safe location.

When the EPB (Electronic Parking Brake) does not release

If the EPB does not release normally, contact an authorized HYUNDAI dealer by loading the vehicle on a flatbed tow truck and have the system checked.

Auto Hold

Auto Hold maintains the vehicle in a standstill even though the brake pedal is not depressed after the driver brings the vehicle to a complete stop by depressing the brake pedal.

To apply:



1. With the driver's door and hood closed, depress the brake pedal and then press the AUTO HOLD switch. The white AUTO HOLD indicator will come on and the system will be in the standby position.

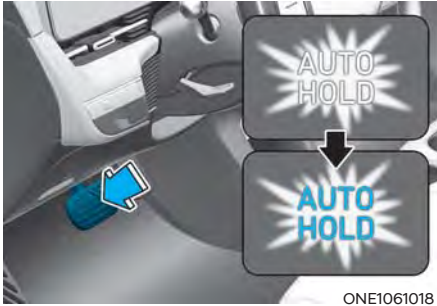

ONE1061018

2. When you stop the vehicle completely by depressing the brake pedal, Auto Hold maintains the brake pressure to hold the vehicle stationary. The indicator changes from white to green.
3. The vehicle will remain stationary even if you release the brake pedal.
4. If EPB is applied, Auto Hold will be released.

To release:

If you depress the accelerator pedal with the gear in D (Drive) or Manual shift mode, the Auto Hold will be released automatically and the vehicle will start to move. The AUTO HOLD indicator changes from green to white.

⚠ WARNING

When Auto Hold is automatically released by depressing the accelerator pedal, always take a look around your vehicle.

Slowly depress the accelerator pedal for a smooth start.

To cancel:



ONE1061019

1. Depress and hold the brake pedal.
2. Press the AUTO HOLD switch. The AUTO HOLD indicator will turn off.

⚠ WARNING

To prevent, unexpected and sudden vehicle movement, **ALWAYS** press your foot on the brake pedal to cancel the Auto Hold before you:

- Drive downhill.
- Drive the vehicle in R (Reverse).
- Park the vehicle.

i Information

- The Auto Hold does not operate when:
 - The gear is in P (Park)
 - EPB is applied
- For your safety, the Auto Hold automatically switches to EPB when:
 - The driver's door is opened
 - The tail gate is opened
 - The hood is opened
 - The vehicle is in a standstill for more than 10 minutes
 - The vehicle is standing on a steep slope
 - The vehicle moved several times

In these cases, the Parking Brake warning light comes on, the AUTO HOLD indicator changes from green to white, and a warning sound and a message will appear to inform you that EPB has been automatically engaged. Before driving off again, depress the brake pedal, check the surrounding area near your vehicle and release the parking brake manually with the EPB switch.

- While operating Auto Hold, you may hear mechanical noise. However, it is normal operating noise.
- If the vehicle is restarted with the Auto Hold system in the standby position or operating, the Auto hold system will continue to operate in the standby position.

NOTICE

If the AUTO HOLD indicator changes to yellow, Auto Hold is not working properly. Contact an authorized HYUNDAI dealer.

! WARNING

- Depress the accelerator pedal slowly when you start the vehicle.
- For your safety, cancel Auto Hold when you drive downhill, back up the vehicle or park the vehicle.

NOTICE

If there is a malfunction with the driver's door or hood open detection system, Auto Hold may not work properly.

Contact an authorized HYUNDAI dealer.

Warning messages

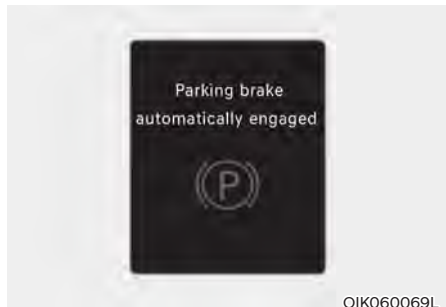

OIK060069L

Parking brake automatically engaged

When EPB is applied while Auto Hold is activated, a warning will sound and a message will appear.



AUTO HOLD turning Off! Press brake pedal

When the conversion from Auto Hold to EPB is not working properly a warning will sound and a message will appear.

When this message is displayed, Auto Hold and EPB may not operate. For your safety, depress the brake pedal.

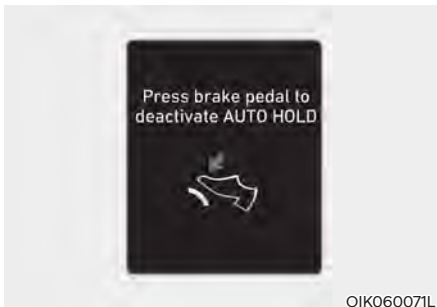

Press brake pedal to deactivate AUTO HOLD

If you did not apply the brake pedal when you release Auto Hold by pressing the AUTO HOLD switch, a warning will sound and a message will appear.

Anti-Lock Brake System (ABS)

WARNING

Anti-Lock Braking System (ABS) or Electronic Stability Control (ESC) system will not prevent accidents due to improper or dangerous driving maneuvers. Even though vehicle control is improved during emergency braking, always maintain a safe distance between you and objects ahead of you. Vehicle speeds should always be reduced during extreme road conditions. The braking distance for vehicles equipped with ABS or ESC may be longer than for those without these systems in the following road conditions.

Drive your vehicle at reduced speeds during the following conditions:

- Rough, gravel or snow-covered roads.
- On roads where the road surface is pitted or has different surface height.
- Tire chains are installed on your vehicle.

The safety features of ABS or ESC equipped vehicle should not be tested by high speed driving or cornering. This could endanger the safety of yourself or others.

ABS is an electronic braking system that helps prevent a braking skid. ABS allows the driver to steer and brake at the same time.

Using ABS

To obtain the maximum benefit from your ABS in an emergency situation, do not attempt to modulate your brake pressure and do not try to pump your brakes. Depress your brake pedal as hard as possible.

When you apply your brakes under conditions which may lock the wheels, you may hear sounds from the brakes, or feel a corresponding sensation in the brake pedal. This is normal and it means your ABS is active.

ABS does not reduce the time or distance it takes to stop the vehicle.

Always maintain a safe distance from the vehicle in front of you.

ABS will not prevent a skid that results from sudden changes in direction, such as trying to take a corner too fast or making a sudden lane change. Always drive at a safe speed for the road and weather conditions.

ABS cannot prevent a loss of stability. Always steer moderately when braking hard. Severe or sharp steering wheel movement can still cause your vehicle to veer into oncoming traffic or off the road.

On loose or uneven road surfaces, operation of the anti-lock brake system may result in a longer stopping distance than for vehicles equipped with a conventional brake system.

The ABS ((ABS)) warning light will stay on for several seconds after the Start/Stop button is in the ON position.

During that time, ABS will go through self-diagnosis and the light will go off if everything is normal. If the light stays on, you may have a problem with your ABS. Contact an authorized HYUNDAI dealer as soon as possible.



WARNING

If the ABS ((ABS)) warning light is on and stays on, you may have a problem with the ABS. Your power brakes will work normally. To reduce the risk of serious injury or death, contact your authorized HYUNDAI dealer as soon as possible.

NOTICE

When you drive on a road having poor traction, such as an icy road, and apply your brakes continuously, ABS will be active continuously and the ABS ((ABS)) warning light may illuminate. Pull your vehicle over to a safe place and turn the vehicle off.

Restart the vehicle. If the ABS warning light is off, then your ABS system is normal.

Otherwise, you may have a problem with your ABS system. Contact an authorized HYUNDAI dealer as soon as possible.

i Information

When you jump start your vehicle because of a drained battery, the ABS ((ABS)) warning light may turn on at the same time. This happens because of the low battery voltage. It does not mean your ABS is malfunctioning. Have the battery recharged before driving the vehicle.

Electronic Stability Control (ESC)



Electronic Stability Control helps to stabilize the vehicle during cornering maneuvers.

ESC checks where you are steering and where the vehicle is actually going. ESC applies braking pressure to any one of the vehicle's brakes and intervenes in the electric vehicle control system to assist the driver with keeping the vehicle on the intended path. It is not a substitute for safe driving practices. Always adjust your speed and driving to the road conditions.

! WARNING

Never drive too fast for the road conditions when cornering. ESC will not prevent accidents.

Excessive speed in turns, abrupt maneuvers, and hydroplaning on wet surfaces can result in severe accidents.

ESC operation

ESC ON condition

When the Start/Stop button is in the ON position, ESC and the ESC OFF indicator lights illuminate for approximately three seconds. After both lights go off, ESC is enabled.

When operating



When ESC is in operation, the ESC indicator light blinks:

- When you apply your brakes under conditions which may lock the wheels, you may hear sounds from the brakes, or feel a corresponding sensation in the brake pedal. This is normal and it means your ESC is active.
- When ESC activates, the vehicle may not respond to the accelerator as it does under routine conditions.
- If Cruise Control was in use when ESC activates, Cruise Control automatically disengages. Cruise Control can be reengaged when the road conditions allow. **See “Cruise Control System” section in chapter 7 (if equipped).**

ESC OFF condition



To cancel ESC operation:

- State 1

Press the ESC OFF button briefly. The ESC OFF indicator light and/or message 'Traction Control disabled' will illuminate. In this state, the traction control function of ESC (electric vehicle control management) is disabled, but the brake control function of ESC (braking management) still operates.

- State 2

Press and hold the ESC OFF button continuously for more than 3 seconds. The ESC OFF indicator light and/or message 'Traction & Stability Control disabled' illuminates and a warning chime sounds. In this state, both the traction control function of ESC (electric vehicle control management) and the brake control function of ESC (braking management) are disabled.

If the Start/Stop button is pressed to the OFF position when ESC is off, ESC remains off. Upon restarting the vehicle, ESC will automatically turn on again.

When ESC (electric vehicle control) is deactivated, the vehicle will lose the traction and stability if the vehicle is driven by abrupt steering wheel control. It is possible that the tire may make a collision with the connected parts of the tire. We recommend to do not turn off ESC while driving the vehicle for your safety.

Indicator lights

- ESC indicator light (blinks)



- ESC OFF indicator light (comes on)



When the Start/Stop button is pressed to the ON position, the ESC indicator light illuminates, then goes off if the ESC system is operating normally.

The ESC indicator light blinks whenever ESC is operating.

If the ESC indicator light stays on, your vehicle may have a malfunction with the ESC system. When this warning light illuminates, have the vehicle checked by an authorized HYUNDAI dealer as soon as possible.

The ESC OFF indicator light comes on when ESC is turned off.



WARNING

When ESC is blinking, this indicates ESC is active:

Drive slowly and NEVER attempt to accelerate. NEVER turn ESC off while the ESC indicator light is blinking or you may lose control of the vehicle resulting in an accident.

NOTICE

Driving with wheels and tires with different sizes may cause the ESC system to malfunction. Before replacing tires, make sure all four tires and wheels are the same size. Never drive the vehicle with different sized wheels and tires installed.

ESC OFF usage**When Driving**

The ESC OFF mode should only be used briefly to help free the vehicle if stuck in snow or mud, by temporarily stopping operation of ESC, to maintain wheel torque.

To turn ESC off while driving, press the ESC OFF button while driving on a flat road surface.

NOTICE

To prevent damage to the reduction gear:

- Do not allow wheel(s) of one axle to spin excessively while the ESC, ABS, and Parking Brake warning lights are displayed. The repairs would not be covered by the vehicle warranty. Reduce motor power and do not spin the wheel(s) excessively while these lights are displayed.
- When operating the vehicle on a dynamometer, make sure ESC is turned off (ESC OFF light illuminated).

i Information

- Turning ESC off does not affect ABS or standard brake system operation.
- Select 0 step of the regenerative braking system and depress the brake pedal around 10 times to efficiently apply brake disc cleaning.

Brake disc cleaning may decrease the driving distance by restraining the regenerative braking system. After brake disc cleaning, the regenerative braking system may be restored.

If the regenerative braking system is not restored after the brake disc cleaning, have the vehicle inspected by an authorized HYUNDAI dealer.

Vehicle Stability Management (VSM)

Vehicle Stability Management is a function of the Electronic Stability Control (ESC) system. It helps the vehicle stay stable when accelerating or braking suddenly on wet, slippery and rough roads where traction over the four tires can suddenly become uneven.



WARNING

Take the following precautions when using Vehicle Stability Management:

- **ALWAYS** check the speed and the distance to the vehicle ahead. **VSM is not a substitute for safe driving practices.**
- **Never drive too fast for the road conditions. VSM will not prevent accidents. Excessive speed in bad weather, on slippery and uneven roads can result in severe accidents.**

VSM operation

When operating

When you apply your brakes under conditions which may activate ESC, you may hear sounds from the brakes, or feel a corresponding sensation in the brake pedal. This is normal and it means your VSM is active.



Information

VSM does not operate when:

- **Driving on a banked road such as gradient or incline.**
- **Driving in reverse.**
- **The ESC OFF indicator light is on.**
- **The MDPS (Motor Driven Power Steering) warning light (⚠) is on or blinks.**

VSM OFF condition

To cancel VSM operation, press the ESC OFF button. ESC OFF (OFF) indicator light will illuminate.

To turn on VSM, press the ESC OFF button again. The ESC OFF indicator light will go out.



WARNING

If the ESC (ESP) indicator light or MDPS (ESP) warning light stays illuminated or blinks, your vehicle may have a malfunction with the VSM system. When the warning light illuminates have the vehicle checked by an authorized HYUNDAI dealer as soon as possible.

NOTICE

Driving with wheels and tires with different sizes may cause the VSM system to malfunction. Before replacing tires, make sure all four tires and wheels are the same size. Never drive the vehicle with different sized tires and wheels installed.

Hill-Start Assist Control (HAC)

Hill-Start Assist Control helps prevent the vehicle from rolling backwards when starting a vehicle from a stop on a hill. The system operates the brakes automatically for approximately 2 seconds (maximum of 5 seconds when the accelerator pedal is slightly depressed during HAC operation) and releases the brake after 2 seconds or when the accelerator pedal is depressed.



WARNING

Always be ready to depress the accelerator pedal when starting off an incline. Hill-Start Assist Control activates only for approximately 2 seconds (maximum of 5 seconds when the accelerator pedal is slightly depressed during HAC operation).



Information

- Hill-Start Assist Control does not operate when the gear is shifted to P (Park) or N (Neutral).
- Hill-Start Assist Control activates even when the ESC (Electronic Stability Control) is off. However, it does not activate, when ESC does not operate normally.

Good Braking Practices



WARNING

Whenever leaving the vehicle or parking, always come to a complete stop and continue to depress the brake pedal. Shift the gear to the P (Park) position, then apply the parking brake, and press the Start/Stop button to the OFF position.

Vehicles parked with the parking brake not applied or not fully engaged may roll inadvertently and may cause injury to the driver and others. ALWAYS apply the parking brake before exiting the vehicle.

Be aware of wet brakes. The brakes may get wet if the vehicle is driven through standing water or if it is washed. Your vehicle will not stop as quickly if the brakes are wet. Wet brakes may cause the vehicle to pull to one side.

To dry the brakes, apply the brakes lightly until the braking action returns to normal. If the braking action does not return to normal, stop as soon as it is safe to do so and call an authorized HYUNDAI dealer for assistance.

DO NOT drive with your foot resting on the brake pedal. Even light, but constant pedal pressure can result in the brakes overheating, brake wear, and possibly even brake failure.

If a tire goes flat while you are driving, apply the brakes gently and keep the vehicle pointed straight ahead while you slow down. When you are moving slowly enough for it to be safe to do so, pull off the road and stop in a safe location.

Keep your foot firmly on the brake pedal when the vehicle is stopped to prevent the vehicle from rolling forward.

ALL WHEEL DRIVE (AWD) (IF EQUIPPED)

When All Wheel Drive(AWD) is activated, driving forces are distributed appropriately to front and rear wheels. It could improve driving performance by maximizing the driving force of vehicles on severe road conditions such as steep hills, unpaved, slippery, etc.

Advantage of electronic AWD

1. Improvement of straight stability
2. Improvement of driving performance on curve
3. Secure stability on severe condition such as wet and sandy roads.
4. Improvement of energy efficiency from driving mode automatic control.



Information

AWD vehicles could change the engagement status of the motor according to the situation required. Auto changing the driving mode(2WD/AWD)helps improve energy efficiency and driving stability.



WARNING

To reduce the risk of **SERIOUS INJURY** or **DEATH**:

- Avoid high speeds when cornering or turning.
- Do not make quick steering wheel movements, such as sharp lane changes or fast, sharp turns.
- The risk of a rollover is greatly increased if you lose control of your vehicle at highway speeds.
- Loss of control often occurs if two or more wheels drop off the roadway and the driver over steers to reenter the roadway.
- In the event your vehicle leaves the roadway, do not steer sharply. Instead, slow down before pulling back into the travel lanes.

NOTICE

- Do not drive in water if the level is higher than the bottom of the vehicle.
- Check your brake condition once you are out of mud or water. Depress the brake pedal several times as you move slowly until you feel normal braking return.
- Shorten your scheduled maintenance interval if you drive in off-road conditions such as sand, mud or water (see "Maintenance Under Severe Usage Conditions" section in chapter 9).
- Always wash your vehicle thoroughly after off road use, especially the bottom of the vehicle.
- Be sure to equip the vehicle with four tires of the same size and type.
- Make sure that a full time AWD vehicle is towed by a flat bed tow truck.

For safe AWD operation

Before driving

- Make sure all passengers are wearing seat belts.
- Sit upright and closer to the steering wheel than usual. Adjust the steering wheel to a position comfortable for you to drive.

Driving on snow-covered or icy roads

- Start off slowly by applying the accelerator pedal gently.
- Use snow tires or tire chains.
- Keep sufficient distance between your vehicle and the vehicle in front of you.
- Using regenerative braking helps the steering on the downhill. However, it may be difficult to adjust the vehicle while coasting using regenerative braking, so avoid using the third level of regenerative braking as much as possible.
- Avoid speeding, rapid acceleration, sudden brake applications, and sharp turns to prevent skids.
- It is difficult to start again if the vehicle stops on an uphill road. Keep your distance from other vehicles and drive slowly.

Information

When using Snow Tires, mount them on all four wheels.

When using tire chains, install them on the rear tires.

However, driving speed must be below 30 km/h and minimize the driving distance. High-speed or long-term driving with tire chains installed may malfunction or damage the AWD system.

For more details on Snow Tires and Tire Chains, refer to "Winter Driving" section later in this chapter.

Driving in sand or mud

- Maintain slow and constant speed.
- Use tire chains driving in mud if necessary.
- Keep sufficient distance between your vehicle and the vehicle in front of you.
- Reduce vehicle speed and always check the road condition.
- Avoid speeding, rapid acceleration, sudden brake applications, and sharp turns to prevent getting stuck.

NOTICE

When the vehicle is stuck in snow, sand or mud, place a nonslip material under the drive wheels to provide traction OR slowly spin the wheels in forward and reverse directions which causes a rocking motion that may free the vehicle.

Driving up or down hills

- Driving uphill
 - Before starting off, check if it is possible to drive uphill.
 - Drive as straight as possible.
- Driving downhill
 - Do not change gear while driving downhill. Select gear before driving downhill.
 - Drive straight as possible.



WARNING

Exercise extreme caution driving up or down steep hills. The vehicle may flip over depending on the grade, terrain, water and mud conditions.

**WARNING**

Do not drive across the contour of steep hills. A slight change in the wheel angle can destabilize the vehicle, or a stable vehicle may lose stability if the vehicle stops its forward motion. Your vehicle may roll over and lead to a serious injury or death.

Additional driving conditions

- Become familiar with the off-road conditions before driving.
- Always pay attention when driving off-road and avoid dangerous areas.
- Drive slowly when driving in heavy wind.
- Reduce vehicle speed when cornering. The center of gravity of AWD vehicles is higher than conventional 2WD vehicles, making them more likely to roll over when you rapidly turn corners.
- Always hold the steering wheel firmly when you are driving off-road.

**WARNING**

Do not grab the inside of the steering wheel when you are driving off-road. You may hurt your arm by a sudden steering maneuver or from steering wheel rebound due to an impact with objects on the ground. You could lose control of the steering wheel which may lead to serious injury or death.

Emergency Precautions***Tires***

When replacing tires, be sure to equip all four tires with the same size, type, tread patterns, brand and load-carrying capacity.

**WARNING**

Do not use tire and wheel with different size and type from the one originally installed on your vehicle. It can affect the safety and performance of your vehicle, which could lead to steering failure or rollover causing serious injury.

 **WARNING**

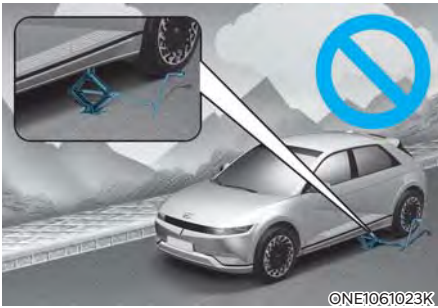

Never start or run the vehicle while an AWD vehicle is raised on a jack. The vehicle can slip or roll off of a jack causing serious injury or death to you or those nearby.

Towing

AWD vehicles must be towed with a wheel lift and dollies or flatbed equipment with all the wheels off the ground. **For more details, refer to "Towing" section in chapter 8.**

Vehicle inspection

- If the vehicle needs to be operated on a vehicle lift do not attempt to stop any of the four wheels from turning. This could damage the AWD system.
- Never engage the parking brake while running the vehicle on a car lift. This may damage the AWD system.

Dynamometer testing

An AWD vehicle must be tested on a special four wheel chassis dynamometer.

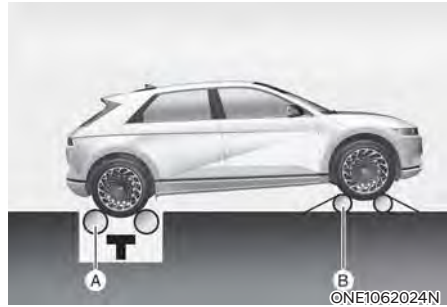

[A]: Roll tester (Speedometer),
[B]: Temporary free roller

An AWD vehicle should not be tested on a 2WD roll tester. If a 2WD roll tester must be used, perform the following procedure:

1. Check the tire pressures recommended for your vehicle.
2. Place the rear wheels on the roll tester for a speedometer test as shown in the illustration.
3. Release the parking brake.
4. Place the front wheels on the temporary free roller as shown in the illustration.

 **WARNING**

Keep away from the front of the vehicle while the vehicle is in gear on the dynamometer. The vehicle can jump forward and cause serious injury or death.

DRIVE MODE INTEGRATED CONTROL SYSTEM (2WD) (IF EQUIPPED)

Drive Mode



Drive mode may be selected according to the driver's preference or road condition.



The mode changes whenever the driver pushes the DRIVE MODE button.

NORMAL mode

Normal mode is a driving mode used when driving on general roads, city center and highways.

ECO mode

ECO mode is a driving mode improving energy efficiency by controlling motors and reduction gear.

Electric energy efficiency varies according to the driver's driving habit and road condition.

- When ECO mode is selected, the ECO indicator will illuminate on the instrument cluster and the color of the mood lamp will change.
- When ECO mode is activated:
 - The acceleration response may be slightly reduced if the accelerator pedal is depressed moderately.
 - The air conditioner performance may be limited.

The above situations are normal conditions when ECO mode is activated to help improve electric energy efficiency.

Limitations of ECO mode

If the following conditions occur while ECO mode is operating, the system operation is limited even though there is no change in the ECO indicator.

- When coolant temperature is low:
 - The system will be limited until motor performance becomes normal.
- When driving up a hill:
 - The system will be limited to gain power when driving uphill because motor torque is restricted.

SPORT mode

SPORT mode is a driving mode improving driving performance by controlling motors and reduction gear. In SPORT mode, the electric energy efficiency may decrease.

- When SPORT mode is selected, the SPORT indicator will illuminate on the instrument cluster and the color of the mood lamp will change.
- Whenever the vehicle is restarted, the drive mode will revert back to NORMAL mode. If SPORT mode is desired, re-select SPORT mode.

SNOW mode

SNOW mode provides safe driving on the snowy roads.

- Press and hold the drive mode button to select SNOW mode.
- When SNOW mode is selected, the SNOW indicator will illuminate on the instrument cluster and the color of the mood lamp will change.

NOTICE

- **Depress the accelerator pedal softly on the snow and the ice.**
- **Keep the distance from the vehicle in the front.**
- **Prevent rapid acceleration, deceleration and steering control. Abrupt driving on the snow may cause the accident.**

DRIVE MODE INTEGRATED CONTROL SYSTEM (AWD) (IF EQUIPPED)

Drive Mode



Drive mode may be selected according to the driver's preference or road condition.

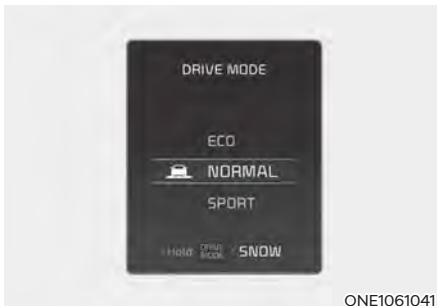

The mode changes whenever the driver pushes the DRIVE mode button.

NORMAL mode

Normal mode is a driving with auto changing the driving mode(2WD/AWD) on road condition.

ECO mode

ECO mode is a driving mode vehicles could change the engagement status of the motor according to the situation required. Auto changing the driving mode(2WD/AWD)helps improve energy efficiency.

Electric energy efficiency varies according to the driver's driving habit and road condition.

- When ECO mode is selected, the ECO indicator will illuminate on the instrument cluster and the color of the mood lamp will change.
- When ECO mode is activated:
 - The acceleration response may be slightly reduced if the accelerator pedal is depressed moderately.
 - The air conditioner performance may be limited.
 - The shift pattern of the reduction gear may change.

The above situations are normal conditions when ECO mode is activated to help improve electric energy efficiency.

Limitations of ECO mode

If the following conditions occur while ECO mode is operating, the system operation is limited even though there is no change in the ECO indicator.

- When coolant temperature is low:
The system will be limited until motor performance becomes normal.
- When driving up a hill:
The system will be limited to gain power when driving uphill because motor torque is restricted.

SPORT mode

SPORT mode is a driving mode improving driving performance by fixing AWD system and controlling reduction gear.

In SPORT mode, the electric energy efficiency may decrease.

- When SPORT mode is selected, the SPORT indicator will illuminate on the instrument cluster and the color of the mood lamp will change.
- Whenever the vehicle is restarted, the drive mode will revert back to NORMAL mode. If SPORT mode is desired, re-select SPORT mode.

SNOW mode

SNOW mode is a driving mode improving driving performance by changing the engagement status of the motor according to the situation required. Auto changing the driving mode(2WD/AWD) helps improve driving stability.

- Press and hold the drive mode button to select SNOW mode.
- When SNOW mode is selected, the SNOW indicator will illuminate on the instrument cluster and the color of the mood lamp will change.
- When SNOW mode is activated, the driving power is distributed to four wheels automatically, increasing the stability of the vehicle.

NOTICE

- **Depress the accelerator pedal softly on the snow and the ice.**
- **Keep the distance from the vehicle in the front.**
- **Prevent rapid acceleration, deceleration and steering control. Abrupt driving on the snow may cause the accident.**

Drive Modes Characteristic

The characteristic of each components varies according to which drive mode is selected.

Drive mode	SNOW	NORMAL	ECO	SPORT
Characteristics	Snow driving	Normal driving mode	High electric energy efficiency mode	Sporty driving mode
Button activation	Press more than 1 sec.	Press	Press	Press
Indicator on the cluster	SNOW	NORMAL	ECO	SPORT
Climate system control	NORMAL	NORMAL	ECO (ECO/NORMAL) *1	NORMAL
Speed Limit	-	-	-	-
Regenerative braking level	0~1	0~3		
BRAKE MODE	NORMAL	NORMAL/SPORT *1	NORMAL	NORMAL/SPORT *1

*1: It is possible to set the driving condition for each drive mode, at the drive mode setting in Infotainment system, For more information, refer to the separately supplied manual.

ACTIVE AIR FLAP



Active air flap system controls the air flap below the front bumper to cool the vehicle parts and improve energy efficiency.

i Information

Active air flap system could be activate regardless of the vehicle condition.(Parking, driving, charging, etc.)

Malfunction



The active air flap system may not operate normally if the air flap is temporarily opened due to foreign factors or if the controller is contaminated by snow or rain, etc.

When "Check the active air flap system" is popped up on display, stop the vehicle in a safe place and check the status of the air flap.

Start the vehicle after performing the necessary work like foreign matter removal and waiting 10 minutes. If the pop-up remains up, contact an authorized HYUNDAI dealer.



CAUTION

- **Regardless of the pop-up, if the air flaps aren't in the same position, stop the vehicle and wait for 10 minutes and start the vehicle and inspect the air flap.**
- **The active air flap system is actuated by motors. Do not disturb actuation or apply force excessively. It may cause failure.**

SPECIAL DRIVING CONDITIONS

Hazardous Driving Conditions

When hazardous driving elements are encountered such as water, snow, ice, mud and sand, take the following precautions:

- Drive cautiously and maintain a longer braking distance.
- Avoid abrupt braking or steering.
- When your vehicle is stuck in snow, mud, or sand, accelerate slowly to avoid unnecessary wheel spin.
- Put sand, rock salt, tire chains or other non-slip materials under the wheels to provide additional traction while the vehicle becomes stuck in ice, snow, or mud.



WARNING

Changing the tire speed suddenly could cause the tires to skid while driving on slippery surface. Be careful when driving on slippery surfaces.

Rocking the Vehicle

If it is necessary to rock the vehicle to free it from snow, sand, or mud, first turn the steering wheel right and left to clear the area around your front wheels. Then, shift back and forth between R (Reverse) and a forward gear.

Try to avoid spinning the wheels, and do not race the vehicle.

To prevent reduction gear wear, wait until the wheels stop spinning before shifting gears. Release the accelerator pedal while shifting, and press lightly on the accelerator pedal while the reduction gear is in gear. Slowly spinning the wheels in forward and reverse directions causes a rocking motion that may free the vehicle.



WARNING

If the vehicle is stuck and excessive wheel spin occurs, the temperature in the tires can increase very quickly.

If the tires become damaged, a tire blow out or tire explosion can occur. This condition is dangerous - you and others may be injured. Do not attempt this procedure if people or objects are anywhere near the vehicle.

If you attempt to free the vehicle, the vehicle can overheat quickly, possibly causing an motor compartment fire or other damage. Try to avoid spinning the wheels as much as possible to prevent overheating of either the tires or the motor. DO NOT allow the vehicle to spin the wheels above 35 mph (56 km/h).

i Information

The ESC system must be turned OFF before rocking the vehicle.

NOTICE

If you are still stuck after rocking the vehicle a few times, have the vehicle pulled out by a tow vehicle to avoid motor overheating, possible damage to the reduction gear, and tire damage. See “Towing” section in chapter 8.

Smooth Cornering

Avoid braking or gear changing in corners, especially when roads are wet. Ideally, corners should always be taken under gentle acceleration.

Driving at Night

Night driving presents more hazards than driving in the daylight. Here are some important tips to remember:

- Slow down and keep more distance between you and other vehicles, as it may be more difficult to see at night, especially in areas where there may not be any street lights.
- Adjust your mirrors to reduce the glare from other drivers’ headlights.
- Keep your headlights clean and properly aimed. Dirty or improperly aimed headlights will make it much more difficult to see at night.
- Avoid staring directly at the headlights of oncoming vehicles. You could be temporarily blinded, and it will take several seconds for your eyes to readjust to the darkness.

Driving in the Rain

Rain and wet roads can make driving dangerous. Here are a few things to consider when driving in the rain or on slick pavement:

- Slow down and allow extra following distance. A heavy rainfall makes it harder to see and increases the distance needed to stop your vehicle.
- Turn OFF your Cruise Control. (if equipped)
- Replace your windshield wiper blades when they show signs of streaking or missing areas on the windshield.
- Be sure your tires have enough tread. If your tires do not have enough tread, making a quick stop on wet pavement can cause a skid and possibly lead to an accident. See “Tire Tread” section in chapter 9.
- Turn on your headlights to make it easier for others to see you.
- Driving too fast through large puddles can affect your brakes. If you must go through puddles, try to drive through them slowly.
- If you believe your brakes may be wet, apply them lightly while driving until normal braking operation returns.

Hydroplaning

If the road is wet enough and you are going fast enough, your vehicle may have little or no contact with the road surface and actually ride on the water. The best advice is SLOW DOWN when the road is wet.

The risk of hydroplaning increases as the depth of tire tread decreases, refer to “Tire Tread” section in chapter 9.

Driving in Flooded Areas

Avoid driving through flooded areas unless you are sure the water is no higher than the bottom of the wheel hub. Drive through any water slowly. Allow adequate stopping distance because brake performance may be reduced.

After driving through water, dry the brakes by gently applying them several times while the vehicle is moving slowly.

Highway Driving

Tires

Adjust the tire inflation, as specified. Under-inflation may overheat or damage the tires.

Do not install worn-out or damaged tires, which may reduce traction or fail the braking operation.

Information

Never over-inflate your tires above the maximum inflation pressure, as specified on your tires.

Coolant and high voltage battery

Driving at higher speeds on the highway consumes more electric energy and is less efficient than driving at a slower, more moderate speed. Maintain a moderate speed in order to conserve electric energy when driving on the highway.

Be sure to check both the coolant level and the electric energy level before driving.

Reducing the Risk of a Rollover

Your multi-purpose passenger vehicle is defined as a Sports Utility Vehicle (SUV). SUV's have higher ground clearance and a narrower track to make them capable of performing in a wide variety of off-road applications. The specific design characteristics give them a higher center of gravity than ordinary vehicles making them more likely to roll over if you make abrupt turns. Utility vehicles have a significantly higher rollover rate than other types of vehicles. Due to this risk, driver and passengers are strongly recommended to buckle their seat belts. In a rollover crash, an unbelted person is significantly more likely to die than a person wearing a seat belt.

There are steps that a driver can make to reduce the risk of a rollover. If at all possible, avoid sharp turns or abrupt maneuvers, do not load your vehicle with heavy cargo on the roof, and never modify your vehicle in any way.



WARNING

Utility vehicles have a significantly higher rollover rate than other types of vehicles. To prevent rollovers or loss of control:

- **Take corners at slower speeds than you would with a passenger vehicle.**
- **Avoid sharp turns and abrupt maneuvers.**
- **Do not modify your vehicle in any way that you would raise the center of gravity.**
- **Keep tires properly inflated.**
- **Do not carry heavy cargo on the roof.**



WARNING

In a rollover crash, an unbelted person is significantly more likely to die than a person wearing a seat belt. Make sure all passengers are wearing their seat belts.

WINTER DRIVING

The severe weather conditions of winter quickly wear out tires and cause other problems. To minimize winter driving problems, you should take the following suggestions:

Snow or Icy Conditions

You need to keep sufficient distance between your vehicle and the vehicle in front of you.

Apply the brakes gently. Speeding, rapid acceleration, sudden brake applications, and sharp turns are potentially very hazardous practices. Sudden brake applications on snowy or icy roads may cause the vehicle to skid.

To drive your vehicle in deep snow, it may be necessary to install tire chains on your tires.

Always carry emergency equipment. Some of the items you may want to carry include tire chains, tow straps or chains, a flashlight, emergency flares, sand, a shovel, jumper cables, a window scraper, gloves, ground cloth, coveralls, a blanket, etc.

Summer tires (if equipped)

- Summer tires are used to maximize the driving performance on dry roads.
- If the temperature is below 7°C or you are driving on snowy or icy roads, the summer tires lose their brake performance and traction as the tire grip weakens significantly.
- If the temperature is below 7°C or you are driving on snowy or icy roads, mount snow tires or all-season tires of the same size with your vehicle's standard tire for safe driving. Both snow and all-season tires have M+S markings.
- When using the M+S tires, use tires with the same tread produced by the same manufacturer for safe driving.
- When driving with the M+S tires with the lower maximum allowable speed than that of the vehicle's standard summer tire, be careful not to exceed the speed allowed for the M+S tires.

Tire chains (Wire chains)



Since the sidewalls of radial tires are thinner than other types of tires, they may be damaged by mounting some types of tire chains on them. Therefore, the use of snow tires is recommended instead of tire chains. If tire chains must be used, use genuine Hyundai parts and install the tire chain after reviewing the instructions provided with the tire chains. Damage to your vehicle caused by improper tire chain use is not covered by your vehicle manufacturer's warranty. When using tire chains, install tire chains only on the rear tires.

WARNING

The use of tire chains may adversely affect vehicle handling:

- Drive less than 20 mph (30 km/h) or the chain manufacturer's recommended speed limit, whichever is lower.
- Drive carefully and avoid bumps, holes, sharp turns, and other road hazards, which may cause the vehicle to bounce.
- Avoid sharp turns or locked wheel braking.

Information

- **Install tire chains only in pairs and on the rear tires. It should be noted that installing tire chains on the tires will provide a greater driving force, but will not prevent side skids.**
- **Do not install studded tires without first checking local and municipal regulations for possible restrictions against their use.**

Tire chains (Auto sock)



Since the sidewalls of radial tires are thinner, they can be damaged by mounting some types of snow chains on them. Therefore, the use of snow tires is recommended instead of snow chains.

Do not mount tire chains on vehicle equipped with aluminum wheels; snow chains may cause damage to the wheels. If snow chains must be used, use AutoSock (fabric snow chain). Damage to your vehicle caused by improper snow chain use is not covered by your vehicle manufacturer's warranty.

When using tire chains, install tire chains only on the rear tires.



CAUTION

Always check chain installation for proper mounting after driving approximately 0.3 to 0.6 miles (0.5 to 1 km) to ensure safe mounting. Retighten or remount the chains if they are loose.

Chain Installation

When installing tire chains, follow the manufacturer's instructions and mount them as tightly possible. Drive slowly (less than 20 mph (30 km/h)) with chains installed. If you hear the chains contacting the body or chassis, stop and tighten them. If they still make contact, slow down until the noise stops. Remove the tire chains as soon as you begin driving on cleared roads.

When mounting snow chains, park the vehicle on level ground away from traffic. Turn on the vehicle Hazard Warning Flasher and place a triangular emergency warning device behind the vehicle (if available). Always place the vehicle in P (Park), apply the parking brake and turn off the vehicle before installing snow chains.

NOTICE

When using tire chains:

- **Wrong size chains or improperly installed chains can damage your vehicle's brake lines, suspension, body and wheels.**
- **Use SAE "S" class or wire chains.**
- **If you hear noise caused by chains contacting the body, retighten the chain to prevent contact with the vehicle body.**
- **To prevent body damage, retighten the chains after driving 0.3-0.6 miles (0.5-1.0 km).**
- **Do not use tire chains on vehicles equipped with aluminum wheels. If unavoidable, use a wire type chain.**
- **Install tire chains that meet the specifications of each tire size to prevent damage your vehicle.**
 - **19 in. tires use wire chains less than 0.47in. (12 mm).**
 - **20 in. tires use AutoSock (fabric snow chain).**

Winter Precautions

Check battery and cables

Winter temperatures affect battery performance. **Inspect the battery and cables, as specified in chapter 9.** The battery charging level can be checked by an authorized HYUNDAI dealer or in a service station.

To prevent locks from freezing

To prevent the locks from being frozen, spray approved de-icing fluid or glycerin into key holes. When a lock opening is already covered with ice, spray approved de-icing fluid over the ice to remove it. When an internal part of a lock freezes, try to thaw it with a heated key. Carefully use the heated key to avoid an injury.

Use approved window washer anti-freeze solution in system

To prevent the window washer from being frozen, add authorized window washer anti-freeze solution, as specified on the window washer container. Window washer anti-freeze solution is available from an authorized HYUNDAI dealer, and most vehicle accessory outlets. Do not use coolant or other types of anti-freeze solution, to prevent any damage to the vehicle paint.

Do not let your parking brake freeze

Under some conditions your parking brake can freeze in the engaged position. This is most likely to happen when there is an accumulation of snow or ice around or near the rear brakes or if the brakes are wet. When there is the risk that your parking brake may freeze, temporarily apply it with the gear in P (Park). Also, block the rear wheels in advance, so the vehicle may not roll. Then, release the parking brake.

Do not let ice and snow accumulate underneath

Under some conditions, snow and ice can build up under the fenders and interfere with the steering. When driving in such conditions during the severe winter, you should check underneath the vehicle on a regular basis, to ensure that the front wheels and the steering components is unblocked.

Carry emergency equipment

In accordance with weather conditions, you should carry appropriate emergency equipment, while driving. Some of the items you may want to carry include tire chains, tow straps or chains, flashlight, emergency flares, sand, shovel, jumper cables, window scraper, gloves, ground cloth, coveralls, blanket, etc.

Do not place objects or materials in the motor compartment

Putting objects or materials in the motor compartment may cause an motor failure. Such damage will not be covered by the manufacturer's warranty.

VEHICLE LOAD LIMIT

Two labels on your driver's door sill show how much weight your vehicle was designed to carry: the Tire and Loading Information Label and the Certification Label.

Before loading your vehicle, familiarize yourself with the following terms for determining your vehicle's weight ratings, from the vehicle's specifications and the Certification Label:

Base Curb Weight

This is the weight of the vehicle including a full tank of fuel and all standard equipment. It does not include passengers, cargo, or optional equipment.

Vehicle Curb Weight

This is the weight of your new vehicle when you picked it up from your dealer plus any aftermarket equipment.

Cargo Weight

This figure includes all weight added to the Base Curb Weight, including cargo and optional equipment.

GAW (Gross Axle Weight)

This is the total weight placed on each axle (front and rear) - including vehicle curb weight and all payload.

GAWR (Gross Axle Weight Rating)

This is the maximum allowable weight that can be carried by a single axle (front or rear). These numbers are shown on the Certification Label. The total load on each axle must never exceed its GAWR.

GVW (Gross Vehicle Weight)

This is the Base Curb Weight plus actual Cargo Weight plus passengers.

GVWR (Gross Vehicle Weight Rating)

This is the maximum allowable weight of the fully loaded vehicle (including all options, equipment, passengers and cargo). The GVWR is shown on the Certification Label located on the driver's door sill.

The Loading Information Label

■ Type A



TIRE AND LOADING INFORMATION
RENSEIGNEMENTS SUR LES PNEUS ET LE CHARGEMENT

SEATING CAPACITY / NOMBRE DE PLACES: TOTAL 5 FRONT 2 REAR 3
The combined weight of occupants and cargo should never exceed 400 kg (880 lbs).
 Le poids total des occupants et du chargement ne doit jamais dépasser 400 kg (880 lbs).

TIRE PNEU	SIZE DIMENSIONS	COLD TIRE PRESSURE / PRESSION DES PNEUS À FROID	SEE OWNER'S MANUAL FOR ADDITIONAL INFORMATION
FRONT AVANT	235/55R19	250kPa, 36psi	VOIR LE MANUEL DE L'USAGER POUR PLUS DE RENSEIGNEMENTS
REAR ARRIÈRE	235/55R19	250kPa, 36psi	
SPARE DE SECOURS	NONE / AUCUN		

ONE1061056N

■ Type B



TIRE AND LOADING INFORMATION
RENSEIGNEMENTS SUR LES PNEUS ET LE CHARGEMENT

SEATING CAPACITY / NOMBRE DE PLACES: TOTAL 5 FRONT 2 REAR 3
The combined weight of occupants and cargo should never exceed 400 kg (880 lbs).
 Le poids total des occupants et du chargement ne doit jamais dépasser 400 kg (880 lbs).

TIRE PNEU	SIZE DIMENSIONS	COLD TIRE PRESSURE / PRESSION DES PNEUS À FROID	SEE OWNER'S MANUAL FOR ADDITIONAL INFORMATION
FRONT AVANT	255/45R20	235kPa, 34psi	VOIR LE MANUEL DE L'USAGER POUR PLUS DE RENSEIGNEMENTS
REAR ARRIÈRE	255/45R20	235kPa, 34psi	
SPARE DE SECOURS	NONE / AUCUN		

ONE1061057N

■ Type C



TIRE AND LOADING INFORMATION
RENSEIGNEMENTS SUR LES PNEUS ET LE CHARGEMENT

SEATING CAPACITY / NOMBRE DE PLACES: TOTAL 5 FRONT 2 REAR 3
The combined weight of occupants and cargo should never exceed 300 kg (660 lbs).
 Le poids total des occupants et du chargement ne doit jamais dépasser 300 kg (660 lbs).

TIRE PNEU	SIZE DIMENSIONS	COLD TIRE PRESSURE / PRESSION DES PNEUS À FROID	SEE OWNER'S MANUAL FOR ADDITIONAL INFORMATION
FRONT AVANT	235/55R19	250kPa, 36psi	VOIR LE MANUEL DE L'USAGER POUR PLUS DE RENSEIGNEMENTS
REAR ARRIÈRE	235/55R19	250kPa, 36psi	
SPARE DE SECOURS	NONE / AUCUN		

ONE1061058N

■ Type D



TIRE AND LOADING INFORMATION
RENSEIGNEMENTS SUR LES PNEUS ET LE CHARGEMENT

SEATING CAPACITY / NOMBRE DE PLACES: TOTAL 5 FRONT 2 REAR 3
The combined weight of occupants and cargo should never exceed 400 kg (880 lbs).
 Le poids total des occupants et du chargement ne doit jamais dépasser 400 kg (880 lbs).

TIRE PNEU	SIZE DIMENSIONS	COLD TIRE PRESSURE / PRESSION DES PNEUS À FROID	SEE OWNER'S MANUAL FOR ADDITIONAL INFORMATION
FRONT AVANT	255/45R20	235kPa, 34psi	VOIR LE MANUEL DE L'USAGER POUR PLUS DE RENSEIGNEMENTS
REAR ARRIÈRE	255/45R20	235kPa, 34psi	
SPARE DE SECOURS	NONE / AUCUN		

ONE1061061N

■ Type E



TIRE AND LOADING INFORMATION
RENSEIGNEMENTS SUR LES PNEUS ET LE CHARGEMENT

SEATING CAPACITY / NOMBRE DE PLACES: TOTAL 5 FRONT 2 REAR 3
The combined weight of occupants and cargo should never exceed 400 kg (880 lbs).
 Le poids total des occupants et du chargement ne doit jamais dépasser 400 kg (880 lbs).

TIRE PNEU	SIZE DIMENSIONS	COLD TIRE PRESSURE / PRESSION DES PNEUS À FROID	SEE OWNER'S MANUAL FOR ADDITIONAL INFORMATION
FRONT AVANT	235/55R19	250kPa, 36psi	VOIR LE MANUEL DE L'USAGER POUR PLUS DE RENSEIGNEMENTS
REAR ARRIÈRE	235/55R19	250kPa, 36psi	
SPARE DE SECOURS	NONE / AUCUN		

ONE1061062N

The label located on the driver's door sill gives the original tire size, cold tire pressures recommended for your vehicle, the number of people that can be in your vehicle and vehicle capacity weight.

Vehicle capacity weight

5 persons (Standard type) :
947 lbs. (430 kg)

5 persons (Extended type) :
859 lbs. (390 kg)

Vehicle capacity weight is the maximum combined weight of occupants and cargo. If your vehicle is equipped with a trailer, the combined weight includes the tongue load.

Seating capacity

Total : 5 persons (Front seat : 2 persons, Rear seat : 3 persons)

Seating capacity is the maximum number of occupants including a driver, your vehicle may carry. However, the seating capacity may be reduced based upon the weight of all of the occupants, and the weight of the cargo being carried or towed. Do not overload the vehicle as there is a limit to the total weight, or load limit including occupants and cargo, the vehicle can carry.

Towing capacity

With brake system :
2,000 lbs (907 kg)

Without brake system :
1,653 lbs (750 kg)

Towing capacity is the maximum trailer weight including its cargo weight, your vehicle can tow.

Cargo capacity

The cargo capacity of your vehicle will increase or decrease depending on the weight and the number of occupants and the tongue load, if your vehicle is equipped with a trailer.







Steps for determining correct load limit

1. Locate the statement "The combined weight of occupants and cargo should never exceed XXX kg or XXX lbs." on your vehicle's placard.
2. Determine the combined weight of the driver and passengers that will be riding in your vehicle.
3. Subtract the combined weight of the driver and passengers from XXX kg or XXX lbs.
4. The resulting figure equals the available amount of cargo and luggage load capacity. For example, if the "XXX" amount equals 1400 lbs. and there will be five 150 lb passengers in your vehicle, the amount of available cargo and luggage load capacity is 650 lbs. (1400 - 750 (5 x 150) = 650 lbs.)
5. Determine the combined weight of luggage and cargo being loaded on the vehicle. That weight may not safely exceed the available cargo and luggage load capacity calculated in Step 4.
6. If your vehicle will be towing a trailer, load from your trailer will be transferred to your vehicle. Consult this manual to determine how this reduces the available cargo and luggage load capacity of your vehicle.



WARNING

Do not overload the vehicle as there is a limit to the total weight, or load limit, including occupants and cargo, the vehicle can carry. Overloading can shorten the life of the vehicle. If the GVWR or the GAWR is exceeded, parts on the vehicle can break, and it can change the handling of your vehicle. These could cause you to lose control and result in an accident.

<p>Example 1</p>	<p>Vehicle Capacity</p> <p>IV</p> <p>Maximum Load (1400 lbs.) (635 kg)</p>	<p></p> <p>Passenger Weight (150 lbs. × 2 = 300 lbs.) (68 kg × 2 = 136 kg)</p>	<p>+</p> <p></p> <p>Cargo Weight (1100 lbs.) (499 kg)</p>
<p>Example 2</p>	<p>Vehicle Capacity</p> <p>IV</p> <p>Maximum Load (1400 lbs.) (635 kg)</p>	<p></p> <p>Passenger Weight (150 lbs. × 5 = 750 lbs.) (68 kg × 5 = 340 kg)</p>	<p>+</p> <p></p> <p>Cargo Weight (650 lbs.) (295 kg)</p>
<p>Example 3</p>	<p>Vehicle Capacity</p> <p>IV</p> <p>Maximum Load (1400 lbs.) (635 kg)</p>	<p></p> <p>Passenger Weight (172 lbs. × 5 = 860 lbs.) (78 kg × 5 = 390 kg)</p>	<p>+</p> <p></p> <p>Cargo Weight (540 lbs.) (245 kg)</p>

Certification label



The certification label is located on the driver's door sill at the center pillar and shows the maximum allowable weight of the fully loaded vehicle. This is called the GVWR (Gross Vehicle Weight Rating). The GVWR includes the weight of the vehicle, all occupants, fuel and cargo.

This label also tells you the maximum weight that can be supported by the front and rear axles, called Gross Axle Weight Rating (GAWR).

The total weight of the vehicle, including all occupants, accessories, cargo, and trailer tongue load must not exceed the Gross Vehicle Weight Rating (GVWR) or the Gross Axle Weight Rating (GAWR). To find out the actual loads on your front and rear axles, you need to go to a weigh station and weigh your vehicle. Be sure to spread out your load equally on both sides of the centerline.

WARNING

Overloading

- Never exceed the GVWR for your vehicle, the GAWR for either the front or rear axle and vehicle capacity weight. Exceeding these ratings can affect your vehicle's handling and braking ability, and cause an accident.
- Do not overload your vehicle. Overloading your vehicle can cause heat buildup in your vehicle's tires and possible tire failure, increased stopping distances and poor vehicle handling—all of which may result in a crash.

NOTICE

Overloading your vehicle may cause damage. Repairs would not be covered by your warranty. Do not overload your vehicle.

**WARNING**

If you carry items inside your vehicle (for example, suitcases, tools, packages, or anything else), they are moving as fast as the vehicle. If you have to stop or turn quickly, or if there is a crash, the items will keep going and can cause an injury if they strike the driver or a passenger.

- Put items in the cargo area of your vehicle. Try to spread the weight evenly.
- Do not stack items, like suitcases, inside the vehicle above the tops of the seats.
- Do not leave an unsecured child restraint in your vehicle.
- When you carry something inside the vehicle, secure it.

TRAILER TOWING

If you are considering to tow with your vehicle, you should first your country's legal requirements. As laws vary the requirements for towing trailers, cars, or other types of vehicles or apparatus may differ. Ask an authorized HYUNDAI dealer for further details before towing.

Remember that trailering is different than just driving your vehicle by itself. Trailering means changes in handling, durability, and electric energy economy. Successful, safe trailering requires correct equipment, and it has to be used properly. Damage to your vehicle caused by improper trailer towing is not covered by your vehicle manufacturer's warranty.

This section contains many time-tested, important trailering tips and safety rules. Many of these are important for your safety and that of your passengers. Please read this section carefully before you pull a trailer.



WARNING

Take the following precautions:

- **If you don't use the correct equipment and/or drive improperly, you can lose control of the vehicle when you are pulling a trailer. For example, if the trailer is too heavy, the braking performance may be reduced. You and your passengers could be seriously or fatally injured. Pull a trailer only if you have followed all the steps in this section.**
- **Before towing, make sure the total trailer weight, GCW (Gross Combination Weight), GVW (Gross Vehicle Weight), GAW (Gross Axle Weight) and trailer tongue load are all within the limits.**

If You Decide to Pull a Trailer

Here are some important points if you decide to pull a trailer:

- Consider using a sway control. You can ask a trailer hitch dealer about sway control.
- Do not do any towing with your vehicle during its first 1,200 miles (2,000 km) in order to allow the vehicle to properly break in. Failure to heed this caution may result in serious motor damage.
- When towing a trailer, consult an authorized HYUNDAI dealer for further information on additional requirements such as towing kit etc.
- Always drive your vehicle at a moderate speed (less than 60 mph (100 km/h)) or posted towing speed limit.
- On a long uphill grade, do not exceed 45 mph (70 km/h) or the posted towing speed limit, whichever is lower.
- Carefully observe the weight and load limits provided in the following pages.

Trailer weight

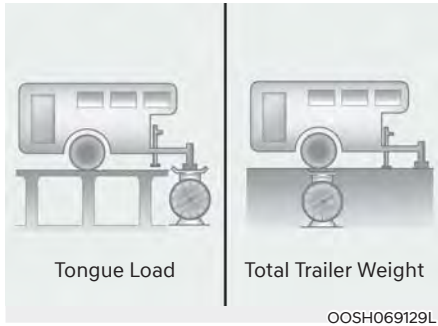

What is the maximum safe weight of a trailer? It should never weigh more than the maximum trailer weight with trailer brakes. But even that can be too heavy. It depends on how you plan to use your trailer. For example, speed, altitude, road grades, outside temperature and how often your vehicle is used to pull a trailer are all important. The ideal trailer weight can also depend on any special equipment that you have on your vehicle.

Tongue load

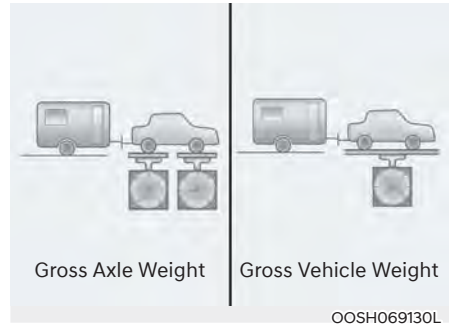

The tongue load is an important weight to measure because it affects the total Gross Vehicle Weight (GVW) of your vehicle. The trailer tongue should weigh a maximum of 10% of the total loaded trailer weight, within the limits of the maximum trailer tongue load permissible.

After you've loaded your trailer, weigh the trailer and then the tongue, separately, to see if the weights are proper. If they aren't, you may be able to correct them simply by moving some items around in the trailer.



WARNING

Take the following precautions:

- **Never load a trailer with more weight in the rear than in the front. The front should be loaded with approximately 60% of the total trailer load; the rear should be loaded with approximately 40% of the total trailer load.**
- **Never exceed the maximum weight limits of the trailer or trailer towing equipment. Improper loading can result in damage to your vehicle and/or personal injury. Check weights and loading at a commercial scale or highway patrol office equipped with scales.**

Reference weight and distance when towing a trailer

Item		Standard type	Extended type
Maximum trailer weight lbs. (kg)	With brake system	-	2,000 (907)
	Without brake system	-	1,653 (750)
Maximum permissible static vertical load on the coupling device lbs. (kg)		-	220 (100)
Recommended distance from rear wheel center to coupling point inch (mm)		-	34 (867)

Trailer Towing Equipment

Hitches

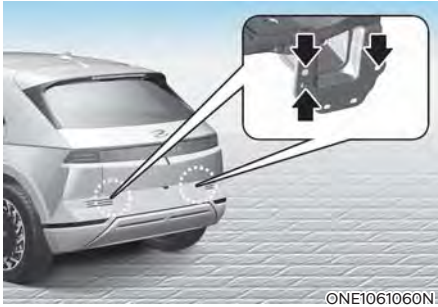

i Information

The mounting hole for hitches are located on both sides of the underbody behind the rear tires.

It's important to have the correct hitch equipment. Crosswinds, large trucks going by, and rough roads are a few reasons why you'll need the right hitch. Here are some rules to follow:

- Do you have to make any holes in the body of your vehicle when you install a trailer hitch? If you do, then be sure to seal the holes later when you remove the hitch. If you don't seal them, dirt and water can get into your vehicle.
- The bumpers on your vehicle are not intended for hitches. Do not attach rental hitches or other bumper-type hitches to them. Use only a frame-mounted hitch that does not attach to the bumper.
- Any part of the rear number plate or lighting devices of the vehicle must not be obscured by the mechanical coupling device.
If the rear number plate and/or lighting devices can be obscured partially by any part of the mechanical coupling device, mechanical coupling devices that can not be easily removed or repositioned without use of any tools, except an easily operated (for example, an effort not exceeding 20Nm) release key which is supplied by the manufacturer of the coupling device, are not permitted for use.
Please note that the mechanical coupling device that is fitted and not in use must always be removed or repositioned if the rear number plate and/or rear lighting devices are obscured by any part of the mechanical coupling device.
- A HYUNDAI Vehicle trailer hitch accessory is available at an authorized HYUNDAI dealer.

Safety chains

You should always attach chains between your vehicle and your trailer.

Instructions about safety chains may be provided by the hitch manufacturer or trailer manufacturer. Follow the manufacturer's recommendation for attaching safety chains. Always leave just enough slack so you can turn with your trailer. And, never allow safety chains to drag on the ground.

Trailer brakes

If your trailer is equipped with a braking system, make sure it conforms to your country's regulations and that it is properly installed and operating correctly.

If your trailer weighs more than the maximum trailer weight without trailer brakes loaded, then it needs its own brakes and they must be adequate. Be sure to read and follow the instructions for the trailer brakes so you'll be able to install, adjust and maintain them properly. Be sure not to modify your vehicle's brake system.



WARNING

Do not use a trailer with its own brakes unless you are absolutely certain that you have properly set up the brake system. This is not a task for amateurs. Use an experienced, competent trailer shop for this work.

Driving with a Trailer

Towing a trailer requires a certain amount of experience. Before setting out for the open road, you must get to know your trailer. Acquaint yourself with the feel of handling and braking with the added weight of the trailer. And always keep in mind that the vehicle you are driving is now longer and not nearly as responsive as your vehicle is by itself.

Before you start, check the trailer hitch and platform, safety chains, electrical connector(s), lights, tires and brakes.

During your trip, occasionally check to be sure that the load is secure, and that the lights and trailer brakes are still working.



Information

When the ambient temperature is lower than 32°F (0°C) and the remaining high voltage battery is low, the power of the vehicle with a trailer can be dropped, causing a trouble in acceleration or drop of the speed when driving hills.

When driving with a trailer, be sure to charge the high voltage battery more than 50% if the ambient temperature is lower than 32°F (0°C).

Distance

Stay at least twice as far behind the vehicle ahead as you would when driving your vehicle without a trailer. This can help you avoid situations that require heavy braking and sudden turns.

Passing

You will need more passing distance up ahead when you're towing a trailer. And, because of the increased vehicle length, you'll need to go much farther beyond the passed vehicle before you can return to your lane.

Backing up

Hold the bottom of the steering wheel with one hand. Then, to move the trailer to the left, move your hand to the left. To move the trailer to the right, move your hand to the right. Always back up slowly and, if possible, have someone guide you.

Making turns

When you're turning with a trailer, make wider turns than normal. Do this so your trailer won't strike soft shoulders, curbs, road signs, trees, or other objects. Avoid jerky or sudden maneuvers. Signal well in advance.

Turn signals

When you tow a trailer, your vehicle has to have a different turn signal flasher and extra wiring. The green arrows on your instrument panel will flash whenever you signal a turn or lane change. Properly connected, the trailer lights will also flash to alert other drivers you're about to turn, change lanes, or stop.

When towing a trailer, the green arrows on your instrument panel will flash for turns even if the bulbs on the trailer are burned out. Thus, you may think drivers behind you are seeing your signals when, in fact, they are not. It's important to check occasionally to be sure the trailer bulbs are still working. You must also check the lights every time you disconnect and then reconnect the wires.



WARNING

Do not connect a trailer lighting system directly to your vehicle's lighting system. Use an approved trailer wiring harness. Failure to do so could result in damage to the vehicle electrical system and/or personal injury. Consult an authorized HYUNDAI dealer for assistance.

Driving on hills

Reduce speed before you start down a long or steep downgrade.

On a long uphill grade, reduce your speed to around 45 mph (70 km/h) to reduce the possibility of motor overheating.

NOTICE

To prevent motor overheating:

When towing a trailer, your vehicle speed may be much slower than the general flow of traffic, especially when climbing an uphill grade. Use the right hand lane when towing a trailer on an uphill grade. Choose your vehicle speed according to the maximum posted speed limit for vehicles with trailers, the steepness of the grade, and your trailer weight.

Parking on hills

Generally, if you have a trailer attached to your vehicle, you should not park your vehicle on a hill.

However, if you ever have to park your trailer on a hill, here's how to do it:

1. Pull the vehicle into the parking space.
Turn the steering wheel in the direction of the curb (right if headed down hill, left if headed up hill).
2. Shift the gear to P (Park).
3. Set the parking brake and shut off the vehicle.
4. Place wheel chocks under the trailer wheels on the down hill side of the wheels.
5. Start the vehicle, hold the brakes, shift to neutral, release the parking brake and slowly release the brakes until the trailer chocks absorb the load.
6. Reapply the brakes and parking brakes.
7. Shift the gear to P (Park) when the vehicle is parked on a uphill grade and in R (Reverse) on a downhill.
8. Shut off the vehicle and release the vehicle brakes but leave the parking brake set.



WARNING

To prevent serious or fatal injury:

- **Do not get out of the vehicle without the parking brake firmly set. If you have left the vehicle running, the vehicle can move suddenly. You and others could be seriously or fatally injured.**
- **Do not apply the accelerator pedal to hold the vehicle on an uphill.**

Driving the vehicle after it has been parked on a hill

1. With the gear in P (Park), apply your brakes and hold the brake pedal down while you:
 - Start your vehicle;
 - Shift into gear; and
 - Release the parking brake.
2. Slowly remove your foot from the brake pedal.
3. Drive slowly until the trailer is clear of the chocks.
4. Stop and have someone pick up and store the chocks.

Maintenance when Towing a Trailer

Your vehicle will need service more often when you regularly pull a trailer. Important items to pay particular attention to include reduction gear fluid, axle lubricant and cooling system fluid. Brake condition is another important item to frequently check. If you're trailering, it's a good idea to review these items before you start your trip. Don't forget to also maintain your trailer and hitch. Follow the maintenance schedule that accompanied your trailer and check it periodically. Preferably, conduct the check at the start of each day's driving. Most importantly, all hitch nuts and bolts should be tight.

NOTICE

To prevent vehicle damage:

- **Due to higher load during trailer usage, overheating might occur on hot days or during uphill driving.**
- **When towing check reduction gear fluid more frequently.**

VEHICLE WEIGHT

Two labels on your driver's door sill show how much weight your vehicle was designed to carry: the Tire and Loading Information Label and the Certification Label.

Before loading your vehicle, familiarize yourself with the following terms for determining your vehicle's weight ratings, from the vehicle's specifications and the Certification Label:

Base Curb Weight

This is the weight of the vehicle including high voltage battery and all standard equipment. It does not include passengers, cargo, or optional equipment.

Vehicle Curb Weight

This is the weight of your new vehicle when you picked it up from your dealer plus any aftermarket equipment.

Cargo Weight

This figure includes all weight added to the Base Curb Weight, including cargo and optional equipment.

GAW (Gross Axle Weight)

This is the total weight placed on each axle (front and rear) - including vehicle curb weight and all payload.

GAWR (Gross Axle Weight Rating)

This is the maximum allowable weight that can be carried by a single axle (front or rear). These numbers are shown on the Certification Label. The total load on each axle must never exceed its GAWR.

GVW (Gross Vehicle Weight)

This is the Base Curb Weight plus actual Cargo Weight plus passengers.

GVWR (Gross Vehicle Weight Rating)

This is the maximum allowable weight of the fully loaded vehicle (including all options, equipment, passengers and cargo). The GVWR is shown on the Certification Label located on the driver's door sill.

Overloading



WARNING

The Gross Axle Weight Rating (GAWR) and the Gross Vehicle Weight Rating (GVWR) for your vehicle are on the Certification Label attached to the driver's (or front passenger's) door. Exceeding these ratings can cause an accident or vehicle damage. You can calculate the weight of your load by weighing the items (and people) before putting them in the vehicle. Be careful not to overload your vehicle.

7. Driver Assistance System

Driving Safety	
Forward Collision-Avoidance Assist (FCA)	7-2
Lane Keeping Assist (LKA).....	7-26
Blind-Spot Collision-Avoidance Assist (BCA).....	7-32
Safe Exit Assist (SEA)	7-46
Manual Speed Limit Assist (MSLA).....	7-53
Intelligent Speed Limit Assist (ISLA).....	7-56
Driver Attention Warning (DAW).....	7-62
Blind-Spot View Monitor (BVM).....	7-68
Driving Convenience	
Smart Cruise Control (SCC).....	7-70
Navigation-based Smart Cruise Control (NSCC).....	7-89
Lane Following Assist (LFA).....	7-97
Highway Driving Assist (HDA).....	7-101
Parking Safety	
Rear View Monitor (RVM).....	7-113
Surround View Monitor (SVM)	7-116
Rear Cross-Traffic Collision-Avoidance Assist (RCCA)	7-122
Reverse Parking Distance Warning (PDW).....	7-134
Forward/Reverse Parking Distance Warning (PDW)	7-137
Reverse Parking Collision-Avoidance Assist (PCA).....	7-142
Parking Convenience	
Remote Smart Parking Assist (RSPA)	7-150
Declaration of Conformity.....	7-175

FORWARD COLLISION-AVOIDANCE ASSIST (FCA) (IF EQUIPPED)

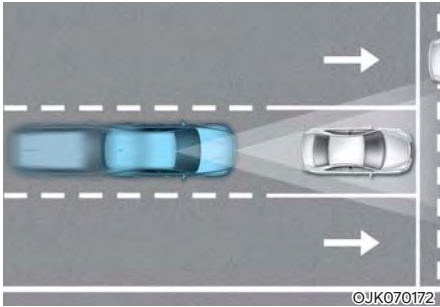

Forward Collision-Avoidance Assist is designed to help detect and monitor the vehicle ahead or help detect a pedestrian or cyclist in the roadway and warn the driver that a collision is imminent with a warning message and an audible warning, apply emergency braking.

In addition, if equipped with front corner radars, when driving at high speeds, Forward Collision-Avoidance Assist helps detect vehicles in front and adjacent lanes. If a collision is imminent when changing lanes, Forward Collision-Avoidance Assist will apply emergency braking to help prevent a collision.

Junction Turning function

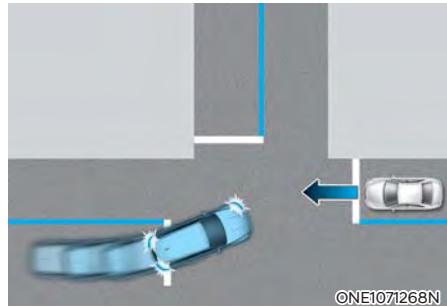

Junction Turning function helps avoid a collision with an oncoming vehicle in an adjacent lane when turning left at a crossroad with the turn signal on by applying emergency braking.

Junction Crossing function (if equipped)

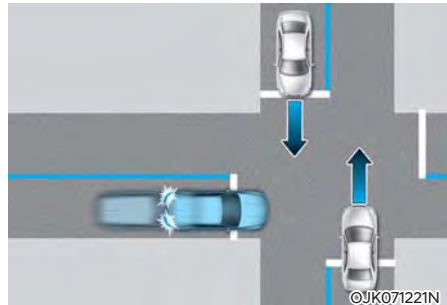

Junction Crossing function helps avoid a collision with oncoming vehicles on the left or right side when crossing an intersection by applying emergency braking.

Lane-Change Oncoming function (if equipped)

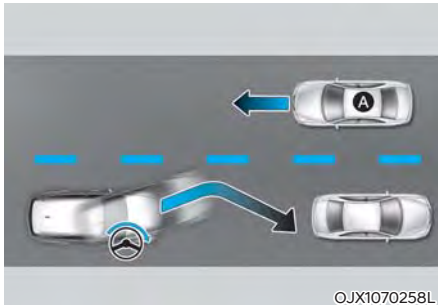

[A] : Oncoming vehicle

Lane-Change Oncoming function helps avoid a collision with an oncoming vehicle when changing lanes by assisting the driver's steering.

Lane-Change Side function (if equipped)

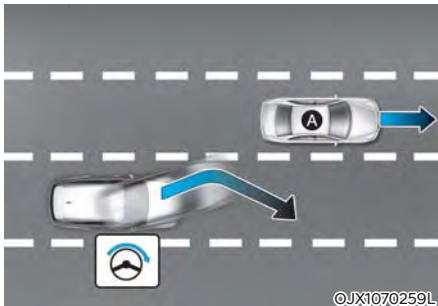

[A] : Front-side vehicle

Lane-Change Side function helps avoid a collision with the vehicle ahead in the next lane when changing lanes by assisting the driver's steering.

Evasive Steering Assist function (if equipped)

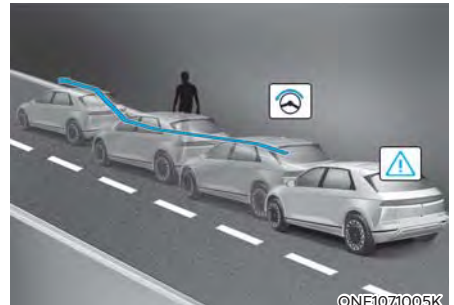

- Driver steering assist
Evasive Steering Assist function helps avoid a collision with a vehicle, pedestrian or cyclist ahead in the same lane. When a risk of collision is detected, Evasive Steering Assist function will warn the driver and if the driver steers to avoid collision it will assist the driver's steering.
- Evasive steering assist
Evasive Steering Assist function helps avoid a collision with a pedestrian or cyclist ahead in the same lane. When a risk of collision is detected, Evasive Steering Assist function will warn the driver and if there is space to avoid collision in the lane, it will assist the driver's steering.

Detecting sensor



©NE1071002K



©NE1071003



©NE1071004N

[1]: Front view camera, [2]: Front radar,
[3]: Front corner radar (if equipped),
[4]: Rear corner radar (if equipped)

Refer to the picture above for the detailed location of the detecting sensors.

CAUTION

Take the following precautions to maintain optimal performance of the detecting sensor:

- Never disassemble the detecting sensor or sensor assembly, or cause any damage to it.
- If the detecting sensors have been replaced or repaired, have the vehicle be inspected by an authorized HYUNDAI dealer.
- Never install any accessories or stickers on the front windshield, or tint the front windshield.
- Pay extreme caution to keep the front view camera dry.
- Never place any reflective objects (for example, white paper, mirror) over the dashboard.
- Do not place any objects near the front windshield or install any accessories on the front windshield. It can affect the performance of the defogging and defrosting function of the climate control system, which may prevent the Driver Assistance systems from operating
- Do not place objects or mount structures near the windshield. When operating the air conditioner, moisture and defrost performance may be poor, and driver assistance functions may not work.
- Do not apply license plate frame or objects, such as a bumper sticker, film or a bumper guard, near the front radar cover.
- Always keep the front radar and cover clean and free of dirt and debris.

Use only a soft cloth to wash the vehicle. Do not spray pressurized water directly on the sensor or sensor cover.

- If unnecessary force has been applied to the radar or around the radar, Forward Collision-Avoidance Assist may not properly operate even though a warning message does not appear on the cluster. Have the vehicle be inspected by an authorized HYUNDAI dealer.
- Use only genuine parts to repair or replace a damaged front radar cover. Do not apply paint to the front radar cover.
- Vehicles equipped with front corner radar and/or rear corner radar
 - Do not apply license plate frame or objects, such as a bumper sticker, film or a bumper guard, near the front corner radar or rear corner radar.
 - The function may not work properly when the bumper has been replaced, or the surroundings of the front corner radar or rear corner radar has been damaged or paint has been applied.
 - If a trailer, carrier, etc., is installed, it may adversely affect the performance of the rear corner radar or Forward Collision-Avoidance Assist may not operate properly.

Forward Collision-Avoidance Assist Settings

Setting features

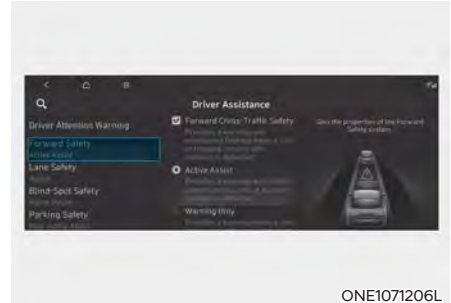

ONE1071206L

Forward Safety

With the vehicle on, select or deselect 'Driver Assistance → Forward Safety' from the Settings menu to set whether or not to use each function.

- If 'Active Assist' is selected, Forward Collision-Avoidance Assist will warn the driver with a warning message and an audible warning depending on the collision risk levels. Braking assist or steering assist (if equipped) will be applied depending on the collision risk level.
- If 'Warning Only' is selected, Forward Collision-Avoidance Assist will warn the driver with a warning message and an audible warning depending on the collision risk levels. Braking and steering (if equipped) will not be assisted. The driver must apply the brake pedal or steer the vehicle if necessary.
- If 'Off' is selected, Forward Collision-Avoidance Assist will turn off. The  warning light illuminates on the cluster.

The driver can monitor Forward Collision-Avoidance Assist On/Off status from the Settings menu. If the  warning light remains on when Forward Collision-Avoidance Assist is on, have the vehicle be inspected by an authorized HYUNDAI dealer.

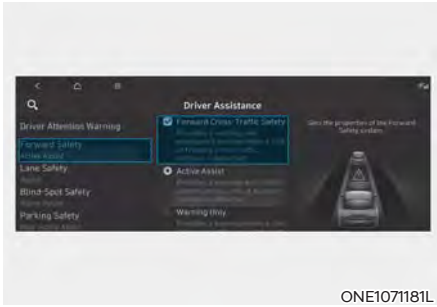

Forward Cross-Traffic Safety (if equipped)

With the vehicle on, select 'Driver Assistance → Forward Safety → Forward Cross-Traffic Safety' from the Settings menu to turn on Junction Crossing function and deselect to turn off the function.

WARNING

When the vehicle is restarted, Forward Collision-Avoidance Assist will always turn on. However, if 'Off' is selected, the driver should always be aware of the surroundings and drive safely.

CAUTION

- If 'Warning Only' is selected, braking and steering (if equipped) is not assisted.
- The settings for Forward Safety include 'Basic function', 'Junction Turning', 'Lane-Change Oncoming', 'Lane-Change Side' and 'Evasive Steering Assist' (if equipped).
- If Forward Safety is set to 'Off', Junction Crossing function will not operate even when 'Forward Cross-Traffic Safety' (if equipped) is selected.

Information

Forward Collision-Avoidance Assist will turn off when ESC is turned off by pressing and holding the ESC OFF button. The  warning light will illuminate on the cluster.

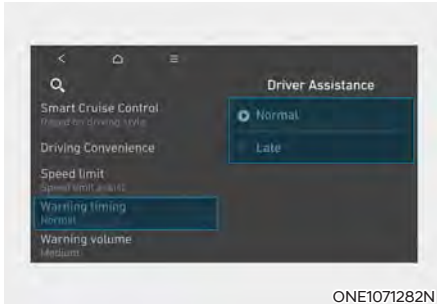

ONE1071282N

Warning Timing

With the vehicle on, select 'Driver Assistance → Warning Timing' from the Settings menu to change the initial warning activation time for Forward Collision-Avoidance Assist.

When the vehicle is first delivered, Warning Timing is set to 'Normal'. If you change the Warning Timing, the Warning Timing of other Driver Assistance systems may change.

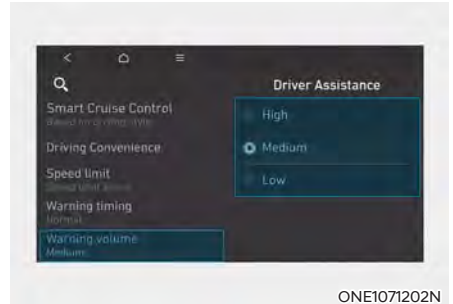

ONE1071202N

Warning Volume

With the vehicle on, select 'Driver Assistance → Warning Volume' from the Settings menu to change the Warning Volume to 'High', 'Medium' or 'Low' for Forward Collision-Avoidance Assist.

If you change the warning volume, the Warning Volume of other Driver Assistance systems may change.



CAUTION

- The setting of the Warning Timing and Warning Volume applies to all functions of Forward Collision-Avoidance Assist.
- Even though 'Normal' is selected for Warning Timing, if the front vehicle suddenly stops, the warning may seem late.
- Select 'Late' for Warning Timing when traffic is light and when driving speed is slow.



Information

If the vehicle is restarted, Warning Timing and Warning Volume will maintain the last setting.

Forward Collision-Avoidance Assist Operation

Basic function

Warning and control

The basic function for Forward Collision-Avoidance Assist is to warn and help control the vehicle depending on the collision risk level: 'Collision Warning', 'Emergency Braking' and 'Stopping vehicle and ending brake control'.



Collision Warning

- To warn the driver of a collision, the 'Collision Warning' warning message will appear on the cluster, an audible warning will sound.
- If a vehicle is detected in front, the function will operate when your vehicle speed is between approximately 6 - 124 mph (10 - 200 km/h).
- If a pedestrian or cyclist is detected in front, the function will operate when your vehicle speed is between approximately 6 - 53 mph (10 - 85 km/h).
- If 'Active Assist' is selected, braking may be assisted.



Emergency Braking

- To warn the driver that emergency braking will be assisted, the 'Emergency Braking' warning message will appear on the cluster, an audible warning will sound.
- If a vehicle is detected in front, the function will operate when your vehicle speed is between approximately 6 - 47 mph (10 - 75 km/h).
- If Forward Collision-Avoidance Assist judges that avoiding a collision is difficult even by changing the driving lane, the function will operate when your vehicle speed is between approximately 6 - 62 mph (10 - 100 km/h) (if equipped with front corner radar).
The function operation range may decrease due to the front traffic condition or the surroundings of the vehicle.
- If a pedestrian or cyclist is detected in front, the function will operate when your vehicle speed is between approximately 6 - 40 mph (10 - 65 km/h).
- In emergency braking situation, braking is assisted with strong braking power by the function to help prevent collision with the vehicle, pedestrian or cyclist ahead.



ONE1071185L

Stopping vehicle and ending brake control

- When the vehicle is stopped due to emergency braking, the 'Drive carefully' warning message will appear on the cluster.
For your safety, the driver should depress the brake pedal immediately and check the surroundings.
- Brake control will end after the vehicle is stopped by emergency braking for approximately 2 seconds.

Junction Turning function

Warning and control

Junction Turning function will warn and control the vehicle depending on the collision risk level: 'Collision Warning', 'Emergency Braking' and 'Stopping vehicle and ending brake control'

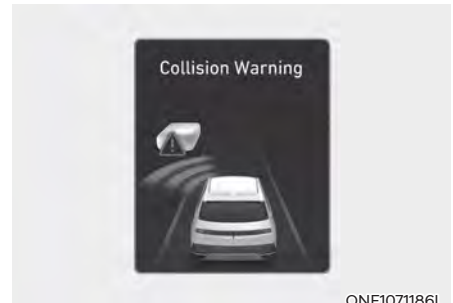

ONE1071186L

Collision Warning

- To warn the driver of a collision, the 'Collision Warning' warning message will appear on the cluster, an audible warning will sound.
- The function will operate when your vehicle speed is between approximately 6 - 19 mph (10 - 30 km/h) and the oncoming vehicle speed is between approximately 19 - 44 mph (30 - 70 km/h).
- If 'Active Assist' is selected, braking may be assisted.

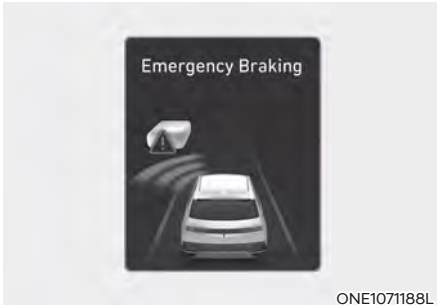

Emergency Braking

- To warn the driver that emergency braking will be assisted, the 'Emergency Braking' warning message will appear on the cluster, an audible warning will sound.
- The function will operate when your vehicle speed is between approximately 6 - 19 mph (10 - 30 km/h) and the oncoming vehicle speed is between approximately 19 - 44 mph (30 - 70 km/h).
- In emergency braking situation, braking is assisted with strong braking power by the function to help prevent collision with the oncoming vehicle.



Stopping vehicle and ending brake control

- When the vehicle is stopped due to emergency braking, the 'Drive carefully' warning message will appear on the cluster.
For your safety, the driver should depress the brake pedal immediately and check the surroundings.
- Brake control will end after the vehicle is stopped by emergency braking for approximately 2 seconds.

i Information

If the driver's seat is on the left side, Junction Turning function will operate only when the driver turns left. If the driver's seat position is on right side, the function will operate only when you turn right.

Junction Crossing function (if equipped)

Warning and control

Junction Crossing function will warn and control the vehicle depending on collision risk level: 'Collision Warning', 'Emergency Braking' and 'Stopping vehicle and ending brake control'



Collision Warning

- To warn the driver of a collision, the 'Collision Warning' warning message will appear on the cluster, an audible warning will sound.
- The function will operate when your vehicle speed is between approximately 6 - 19 mph (10 - 30 km/h) and the crossing vehicle speed is between approximately 6 - 37 mph (10 - 60 km/h).
- If 'Active Assist' and 'Forward Cross-Traffic Safety' are selected, braking may be assisted.

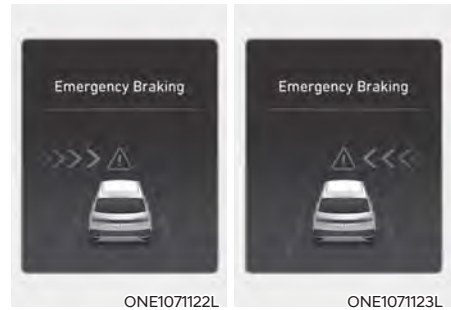

Emergency Braking

- To warn the driver that emergency braking will be assisted, the 'Emergency Braking' warning message will appear on the cluster, an audible warning will sound.
- The function will operate when your vehicle speed is between approximately 6 - 19 mph (10 - 30 km/h) and the crossing vehicle speed is between approximately 6 - 12 mph (10 - 20 km/h).
- In emergency braking situation, braking is assisted with strong braking power by the function to help prevent collision with the crossing vehicle.



ONE1071185L

Stopping vehicle and ending brake control

- When the vehicle is stopped due to emergency braking, the 'Drive carefully' warning message will appear on the cluster.
For your safety, the driver should depress the brake pedal immediately and check the surroundings.
- Brake control will end after the vehicle is stopped by emergency braking for approximately 2 seconds.

CAUTION

If the collision angle with the crossing vehicle is beyond a certain range, Junction Crossing function warning and control may be late or may not operate.

Lane-Change Oncoming function (if equipped)

Warning and control

Lane-Change Oncoming function will warn and control the vehicle depending on collision risk level: 'Collision Warning' and 'Emergency Steering'



ONE1071186L

Collision Warning

- To warn the driver of a collision, the 'Collision Warning' warning message will appear on the cluster, an audible warning will sound.
- The function will operate when your vehicle speed is between approximately 25 - 90 mph (40 - 145 km/h) and the oncoming vehicle speed is approximately above 6 mph (10 km/h) and the relative speed with your vehicle is approximately below 124 mph (200 km/h).



Emergency Steering

- To warn the driver that emergency steering will be assisted, the 'Emergency Steering' warning message will appear on the cluster, an audible warning will sound.
- The function will operate when your vehicle speed is between approximately 25 - 90 mph (40 - 145 km/h) and the oncoming vehicle speed is approximately above 6 mph (10 km/h) and the relative speed with your vehicle is approximately below 124 mph (200 km/h).
- In emergency steering situation, steering is assisted by the function to help prevent collision with the oncoming vehicle.

Lane-Change Side function (if equipped)

Warning and control

Lane-Change Side function will warn and control the vehicle depending on collision risk level: 'Collision Warning' and 'Emergency Steering'



Collision Warning

- To warn the driver of a collision, the 'Collision Warning' warning message will appear on the cluster, an audible warning will sound.
- The function will operate when your vehicle speed is between approximately 25 - 90 mph (40 - 145 km/h).



Emergency Steering

- To warn the driver that emergency steering will be assisted, the 'Emergency Steering' warning message will appear on the cluster, an audible warning will sound.
- The function will operate when your vehicle speed is between approximately 25 - 90 mph (40 - 145 km/h).
- In emergency steering situation, steering is assisted by the function to help prevent collision with the front-side vehicle.



CAUTION

Lane-Change Side function does not operate if the vehicle speed of the oncoming vehicle from the front side is 0 mph (0 km/h).

Evasive Steering Assist function (if equipped)

Warning and control

Evasive Steering Assist function will warn and control the vehicle with 'Emergency steering'.

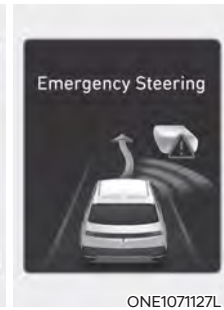

Emergency Steering (Driver steering assist)

- To warn the driver that emergency steering will be assisted, the 'Emergency Steering' message will appear on the cluster, an audible warning will sound.
- The function will operate when your vehicle speed is between approximately 25 - 53 mph (40 - 85 km/h).
- If there is a risk of collision with a vehicle, pedestrian and cyclist in front, the steering will be assisted to help prevent collision when the driver steers the vehicle to avoid collision.



Emergency Steering (Evasive steering assist)

- To warn the driver that emergency steering will be assisted, the 'Emergency Steering' message will appear on the cluster, an audible warning will sound.
- The function will operate when your vehicle speed is between approximately 40 - 47 mph (65 - 75 km/h).
- If there is high risk of collision with a pedestrian and cyclist in front, and the vehicle speed to operate emergency braking is within the operation range, the steering will be assisted to help prevent collision when there is space to avoid collision in the driving lane.



CAUTION

- The steering wheel may turn automatically when emergency steering is operating.
- Emergency steering will automatically cancel when risk factors disappear. If necessary, the driver must steer the vehicle.
- Emergency steering may not operate or may cancel during operation if the steering wheel is held tight or steered in the opposite direction.
- When steering is assisted to avoid collision with a vehicle, pedestrian and cyclist, Evasive steering assist will be canceled if collisions with other objects (vehicles, pedestrians, or cyclists) are expected.
- Evasive steering assist may not operate if space to avoid collision in the driving lane is insufficient.



Information

For more details on warning messages, refer to Collision Warning in "Basic Function".



Information

The images or colors may be displayed differently depending on the specifications of the instrument panel or theme.



WARNING

Take the following precautions when using Forward Collision-Avoidance Assist:

- For your safety, change the Settings after parking the vehicle at a safe location.
- With 'Active Assist' or 'Warning Only' selected, when ESC is turned off by pressing and holding the ESC OFF button, Forward Collision-Avoidance Assist will turn off automatically. In this case, Forward Collision-Avoidance Assist cannot be set from the Settings menu and the warning light will illuminate on the cluster which is normal. If ESC is turned on by pressing the ESC OFF button, Forward Collision-Avoidance Assist will maintain the last setting.
- Forward Collision-Avoidance Assist does not operate in all situations or cannot avoid all collisions.
- The driver should hold the responsibility to control the vehicle. Do not solely depend on Forward Collision-Avoidance Assist. Rather, maintain a safe braking distance, and if necessary, depress the brake pedal to reduce driving speed or to stop the vehicle.
- Never deliberately operate Forward Collision-Avoidance Assist on people, objects, etc. It may cause serious injury or death.
- Forward Collision-Avoidance Assist may not operate if the driver depresses the brake pedal to avoid collision.

- Depending on the road and driving conditions, Forward Collision-Avoidance Assist may warn the driver late or may not warn the driver.
- During Forward Collision-Avoidance Assist operation, the vehicle may stop suddenly injuring passengers and shifting loose objects. Always have the seat belt on and keep loose objects secured.
- If any other system's warning message is displayed or audible warning is generated, Forward Collision-Avoidance Assist warning message may not be displayed and audible warning may not be generated.
- You may not hear the warning sound of Forward Collision-Avoidance Assist if the surrounding is noisy.
- Forward Collision-Avoidance Assist may turn off or may not operate properly or may operate unnecessarily depending on the road conditions and the surroundings.



WARNING

- Even if there is a problem with Forward Collision-Avoidance Assist, the vehicle's basic braking performance will operate properly.
- During emergency braking, braking control by Forward Collision-Avoidance Assist will automatically cancel when the driver excessively depresses the accelerator pedal or sharply steers the vehicle.



CAUTION

- Depending on the condition of the vehicle, pedestrian and cyclist in front and the surroundings, the speed range to operate Forward Collision-Avoidance Assist may reduce. Forward Collision-Avoidance Assist may only warn the driver, or it may not operate.
- Forward Collision-Avoidance Assist will operate under certain conditions by judging the risk level based on the condition of the oncoming vehicle, driving direction, speed and surroundings.
- When a collision with a surrounding vehicle is expected, Lane-Change Oncoming, Lane-Change Side and Evasive Steering Assist functions will only warn the driver (if equipped).



Information



- In a situation where collision is imminent, braking may be assisted by Forward Collision-Avoidance Assist when braking is insufficient by the driver.
- The images and colors in the instrument cluster may differ depending on the cluster type or theme selected from the instrument cluster.

Forward Collision-Avoidance Assist Malfunction and Limitations

Forward Collision-Avoidance Assist malfunction





OTM070094N

When Forward Collision-Avoidance Assist is not working properly, the 'Check Forward Safety' warning message will appear, and the  and  warning lights will illuminate on the cluster. Have the vehicle be inspected by an authorized HYUNDAI dealer.

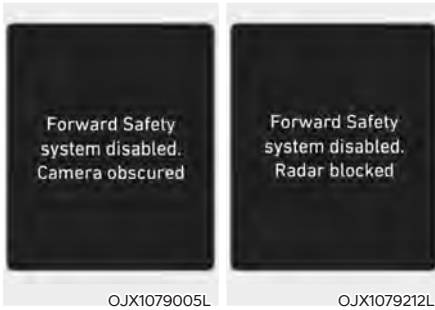
Forward Collision-Avoidance Assist disabled



When the front windshield where the front view camera is located, front radar cover, bumper or sensor is covered with foreign material, such as snow or rain, it can reduce the detecting performance and temporarily limit or disable Forward Collision-Avoidance Assist.

If this occurs the 'Forward Safety system disabled. Camera obscured' or the 'Forward Safety system disabled. Radar blocked' warning message, and the  and  warning lights will illuminate on the cluster.

Forward Collision-Avoidance Assist will operate properly when snow, rain or foreign material is removed.

If Forward Collision-Avoidance Assist does not operate properly after obstruction (snow, rain, or foreign material) is removed (including trailer, carrier, etc., from the rear bumper), have the vehicle inspected by an HYUNDAI dealer.

WARNING

- Even though the warning message or warning light does not appear on the cluster, Forward Collision-Avoidance Assist may not properly operate.
- Forward Collision-Avoidance Assist may not properly operate in an area (for example, open terrain), where any objects are not detected after turning ON the vehicle.

Limitations of Forward Collision-Avoidance Assist

Forward Collision-Avoidance Assist may not operate properly, or it may operate unexpectedly under the following circumstances:

- The detecting sensor or the surroundings are contaminated or damaged
- The temperature around the front view camera is high or low due to surrounding environment
- The camera lens is contaminated due to tinted, filmed or coated windshield, damaged glass, or sticky foreign material (sticker, bug, etc.) on the glass
- Moisture is not removed or frozen on the windshield
- Washer fluid is continuously sprayed, or the wiper is on
- Driving in heavy rain or snow, or thick fog
- The field of view of the front view camera is obstructed by sun glare
- Street light or light from an oncoming traffic is reflected on the wet road surface, such as a puddle on the road
- An object is placed on the dashboard

- Your vehicle is being towed
- The surrounding is very bright
- The surrounding is very dark, such as in a tunnel, etc.
- The brightness changes suddenly, for example when entering or exiting a tunnel
- The brightness outside is low, and the headlights are not on or are not bright
- Driving through steam, smoke or shadow
- Only part of the vehicle, pedestrian or cyclist is detected
- The vehicle in front is a bus, heavy truck, truck with an unusually shaped cargo, trailer, etc.
- The vehicle in front has no tail lights, tail lights are located unusually, etc.
- The brightness outside is low, and the tail lamps are not on or are not bright
- The rear of the front vehicle is small or the vehicle does not look normal, such as when the vehicle is tilted, overturned, or the side of the vehicle is visible, etc.
- The front vehicle's ground clearance is low or high
- A vehicle, pedestrian or cyclist suddenly cuts in front
- The bumper around the front radar is impacted, damaged or the front radar is out of position
- The temperature around the front radar is high or low
- Driving through a tunnel or iron bridge
- Driving in vast areas where there are few vehicles or structures (for example, desert, meadow, suburb, etc.)
- Driving near areas containing metal substances, such as a construction zone, railroad, etc.
- A material is near that reflects very well on the front radar, such as a guardrail, nearby vehicle, etc.
- The cyclist in front is on a bicycle made of material that does not reflect on the front radar
- The vehicle in front is detected late
- The vehicle in front is suddenly blocked by an obstacle
- The vehicle in front suddenly changes lane or suddenly reduces speed
- The vehicle in front is bent out of shape
- The front vehicle's speed is fast or slow
- The vehicle in front steers in the opposite direction of your vehicle to avoid a collision
- With a vehicle in front, your vehicle changes lane at low speed
- The vehicle in front is covered with snow
- You are departing or returning to the lane
- Unstable driving
- You are on a roundabout and the vehicle in front is not detected
- You are continuously driving in a circle
- The vehicle in front has an unusual shape
- The vehicle in front is driving uphill or downhill
- The pedestrian or cyclist is not fully detected, for example, if the pedestrian is leaning over or is not fully walking upright
- The pedestrian or cyclist is wearing clothing or equipment that makes it difficult to detect



The illustration above shows the image the front view camera and front radar is capable of detecting as a vehicle, pedestrian and cyclist.

- The pedestrian or cyclist in front is moving very quickly
 - The pedestrian or cyclist in front is short or is posing a low posture
 - The pedestrian or cyclist in front has impaired mobility
 - The pedestrian or cyclist in front is moving intersected with the driving direction
 - There is a group of pedestrians, cyclists or a large crowd in front
 - The pedestrian or cyclist is wearing clothing that easily blends into the background, making it difficult to detect
 - The pedestrian or cyclist is difficult to distinguish from the similarly shaped structure in the surroundings
- You are driving by a pedestrian, cyclist, traffic signs, structures, etc., near the intersection
 - Driving in a parking lot
 - Driving through a tollgate, construction area, unpaved road, partial paved road, uneven road, speed bumps, etc.
 - Driving on an incline road, curved road, etc.
 - Driving through a roadside with trees or streetlights
 - The adverse road conditions cause excessive vehicle vibrations while driving
 - Your vehicle height is low or high due to heavy loads, abnormal tire pressure, etc.
 - Driving through a narrow road where trees or grass are overgrown
 - There is interference by electromagnetic waves, such as driving in an area with strong radio waves or electrical noise

Junction Crossing, Lane-Change Oncoming, Lane-Change Side, Evasive Steering Assist function (if equipped)

- The temperature around the front corner radar or rear corner radar is high or low
- A trailer or carrier is installed around the rear corner radar
- The front corner radar or rear corner radar is covered with snow, rain, dirt, etc.
- The bumper around the front corner radar or rear corner radar is covered with objects, such as a bumper sticker, bumper guard, bike rack, etc.
- The bumper around the front corner radar or rear corner radar is impacted, damaged or the radar is out of position
- The front corner radar or rear corner radar is blocked by other vehicles, walls or pillars
- Driving on a highway ramp
- Driving on a road where the guardrail or wall is in double structure
- The other vehicle drives very close behind your vehicle, or the other vehicle passes by your vehicle in close proximity
- The speed of the other vehicle is very fast that it passes by your vehicle in a short time
- Your vehicle passes by the other vehicle
- Your vehicle has started at the same time as the vehicle next to you and has accelerated
- The vehicle in the next lane moves two lanes away from you, or when the vehicle two lanes away moves to the next lane from you
- A motorcycle or bicycle is detected
- A vehicle such as a flat trailer is detected
- A big vehicle such as a bus or truck is detected
- A small moving obstacle such as a pedestrian, animal, shopping cart or a baby stroller is detected
- A vehicle with low height such as a sports car is detected
- The lane is difficult to see due to foreign material, such as rain, snow, dust, sand, oil and water puddles
- The color of the lane marking is not distinguishable from the road

- There are markings on the road near the lane or the markings on the road looks similar to the lane markings
- The shadow is on the lane marking by a median strip, trees, guardrail, noise barriers, etc.
- The lane number increases or decreases, or the lane markings are crossing
- There are more than two lane markings on the road
- The lane markings are complicated or a structure substitutes for the lines, such as a construction area
- There are road markings, such as zigzag lanes, crosswalk markings and road signs
- The lane suddenly disappears, such as at the intersection
- The lane is very wide or narrow
- There is a curb or road edges without a lane
- The vehicle in front is driving with one side on the lane marking
- The distance to the front vehicle is extremely short



WARNING

- Driving on a curved road

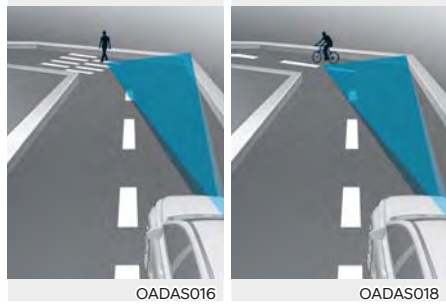
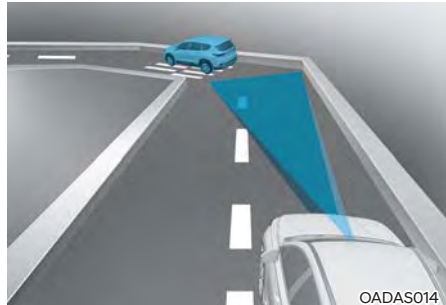

Forward Collision-Avoidance Assist may not detect other vehicles, pedestrians or cyclists in front of you while driving on curved roads adversely affecting the performance of the sensors. This may result in no warning, braking assist or steering assist (if equipped) when necessary. When driving on a curved road, you must maintain a safe braking distance, and if necessary, steer the vehicle and depress the brake pedal to reduce your driving speed in order to maintain a safe distance.

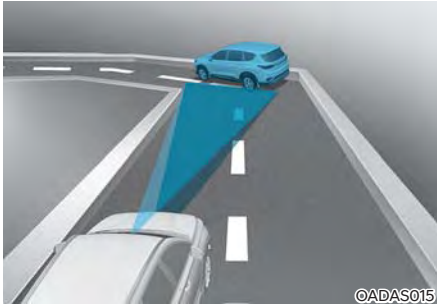

OADAS015



OADAS017



OADAS019

Forward Collision-Avoidance Assist may detect a vehicle, pedestrian or cyclist in the next lane or outside the lane when driving on a curved road. If this occurs, Forward Collision-Avoidance Assist may unnecessarily warn the driver and control the brake or steering wheel (if equipped). Always check the traffic conditions around the vehicle.

- **Driving on an inclined road**



OADAS012

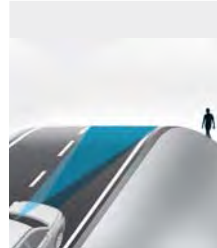

OADAS010

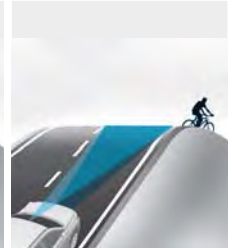

OADAS011

Forward Collision-Avoidance Assist may not detect other vehicles, pedestrians or cyclists in front of you while driving uphill or downhill, adversely affecting the performance of the sensors.

This may result in unnecessary warning, braking assist or steering assist (if equipped) or no warning, braking assist or steering assist (if equipped) when necessary.

Also, vehicle speed may rapidly decrease when a vehicle, pedestrian or cyclist ahead is suddenly detected.

Always have your eyes on the road while driving uphill or downhill and if necessary, steer your vehicle and depress the brake pedal to reduce your driving speed in order to maintain a safe distance.

- Changing lanes

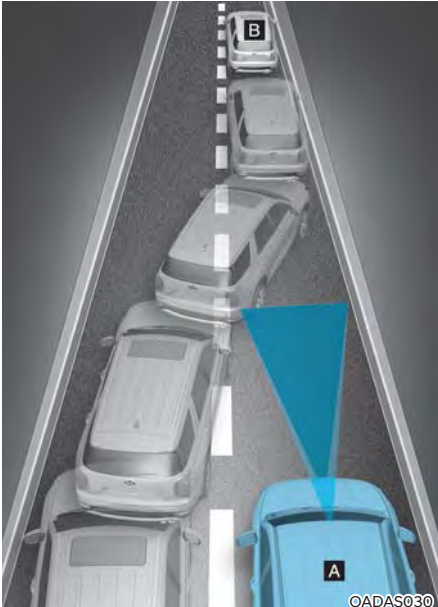

[A] : Your vehicle, [B] : Lane changing vehicle

When a vehicle moves into your lane from an adjacent lane, it cannot be detected by the sensor until it is in the sensor's detection range. Forward Collision-Avoidance Assist may not immediately detect the vehicle when the vehicle changes lanes abruptly. In this case, you must maintain a safe braking distance, and if necessary, steer your vehicle and depress the brake pedal to reduce your driving speed in order to maintain a safe distance.

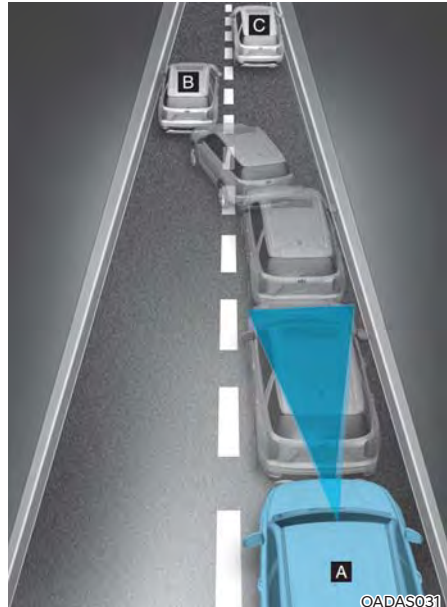

[A] : Your vehicle, [B] : Lane changing vehicle,
[C] : Same lane vehicle

When a vehicle in front of you merges out of the lane, Forward Collision-Avoidance Assist may not immediately detect the vehicle that is now in front of you. In this case, you must maintain a safe braking distance, and if necessary, steer your vehicle and depress the brake pedal to reduce your driving speed in order to maintain a safe distance.

- Detecting vehicle

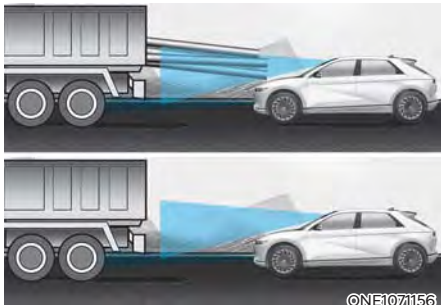

If the vehicle in front of you has cargo that extends rearward from the cab, or when the vehicle in front of you has higher ground clearance, additional special attention is required. Forward Collision-Avoidance Assist may not be able to detect the cargo extending from the vehicle. In these instances, you must maintain a safe braking distance from the rearmost object, and if necessary, steer your vehicle and depress the brake pedal to reduce your driving speed in order to maintain distance.

WARNING

- When you are towing a trailer or another vehicle, turn off Forward Collision-Avoidance Assist for to safety reasons.
- Forward Collision-Avoidance Assist may operate if objects that are similar in shape or characteristics to vehicles, pedestrians and cyclists are detected.
- Forward Collision-Avoidance Assist does not operate on bicycles, motorcycles, or smaller wheeled objects, such as luggage bags, shopping carts, or strollers.

- Forward Collision-Avoidance Assist may not operate properly if interfered by strong electromagnetic waves.
- Forward Collision-Avoidance Assist may not operate for 15 seconds after the vehicle is started, or the front view camera is initialized.

Information

In some instances, FCA system may be canceled when subjected to electromagnetic interference.

Information

This device complies with Part 15 of the FCC rules.

Operation is subject to the following three conditions:

1. This device may not cause harmful interference, and
2. This device must accept any interference received, including interference that may cause undesired operation of the device.
3. Changes or modifications not expressly approved by the party responsible for compliance could void the user's authority to operate the device.

Information

Radio frequency radiation exposure information:

This equipment complies with FCC radiation exposure limits set forth for an uncontrolled environment.

This equipment should be installed and operated with minimum distance of 8 in. (20 cm) between the radiator (antenna) and your body.

This transmitter must not be co-located or operating in conjunction with any other antenna or transmitter.

LANE KEEPING ASSIST (LKA)

Lane Keeping Assist is designed to help detect lane markings (or road edges) while driving over a certain speed. Lane Keeping Assist will warn the driver if the vehicle leaves the lane without using the turn signal, or will automatically assist the driver's steering to help prevent the vehicle from departing the lane.

Detecting sensor



[1] : Front view camera

The front view camera is used as a detecting sensor to detect lane markings (or road edges).

Refer to the picture above for the detailed location of the detecting sensor.

CAUTION

For more details on the precautions of the front view camera, refer to “Forward Collision-Avoidance Assist (FCA)” section in this chapter.

Lane Keeping Assist Settings

Setting features

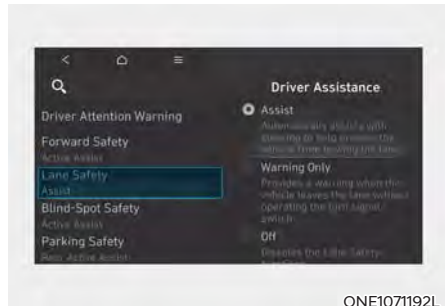

ONE1071192L

Lane Safety

With the vehicle on, select or deselect 'Driver Assistance → Lane Safety' from the Settings menu to set whether to use each function.

- If 'Assist' is selected, Lane Keeping Assist will automatically assist the driver's steering when lane departure is detected to help prevent the vehicle from moving out of its lane.
- If 'Warning Only' is selected, Lane Keeping Assist will warn the driver with an audible warning when lane departure is detected. The driver must steer the vehicle.
- If 'Off' is selected, Lane Keeping Assist will turn off. The  indicator light will turn off on the cluster.

WARNING

- If 'Warning Only' is selected, steering is not assisted.
- Lane Keeping Assist does not control the steering wheel when the vehicle is driven in the middle of the lane.
- The driver should always be aware of the surroundings and steer the vehicle if 'Off' is selected.

Turning Lane Keeping Assist On/Off

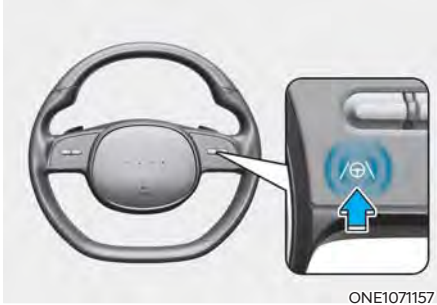

With the vehicle on, press and hold the Lane Driving Assist button located on the steering wheel to turn on Lane Keeping Assist. The grey  indicator light will illuminate on the cluster.

Press and hold the button again to turn off the function.

If the vehicle is restarted, Lane Keeping Assist will maintain the last setting.

Information

- **When the Lane Driving Assist button is pressed shortly, Lane Following Assist will turn on and off.**
- **When Lane Keeping Assist is turned off with the Lane Driving Assist button, the Lane Safety setting also changes to 'Off'.**

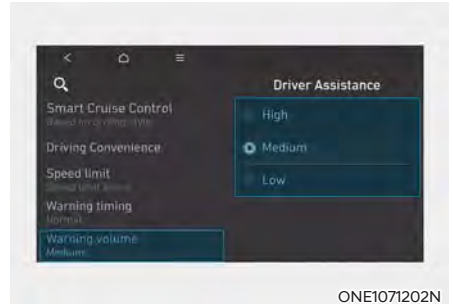

Warning Volume

With the vehicle on, select 'Driver Assistance → Warning Volume' from the Settings menu to change the Warning Volume to 'High', 'Medium' or 'Low' for Lane Keeping Assist.

If you change the warning volume, the Warning Volume of other Driver Assistance systems may change.

Lane Keeping Assist Operation

Warning and control

Lane Keeping Assist will warn and help control the vehicle with Lane Departure Warning and Lane Keeping Assist.



Lane Departure Warning

- To warn the driver that the vehicle is departing from the projected lane in front, the green  indicator light will blink on the cluster, the lane line will blink on the cluster depending on which direction the vehicle is veering, and an audible warning will sound.
- Lane Keeping Assist will operate when your vehicle speed is between approximately 40 - 120 mph (60 - 200 km/h).

Lane Keeping Assist

- To warn the driver that the vehicle is departing from the projected lane in front, the green  indicator light will blink on the cluster, and the steering wheel will make adjustments to keep vehicle inside the lane.
- Lane Keeping Assist will operate when your vehicle speed is between approximately 40 - 120 mph (60 - 200 km/h).



Hands-off warning

If the driver takes their hands off the steering wheel for several seconds, the 'Place hands on the steering wheel' warning message will appear on the cluster, and an audible warning will sound in stages.

WARNING

- The steering wheel may not be assisted if the steering wheel is held very tight or the steering wheel is steered over a certain degree.
- Lane Keeping Assist does not operate at all times. It is the responsibility of the driver to safely steer the vehicle and to maintain the vehicle in its lane.
- The hands-off warning message may appear late depending on road conditions. Always have your hands on the steering wheel while driving.
- If the steering wheel is held very lightly, the hands-off warning message may appear because Lane Keeping Assist may not recognize that the driver has their hands on the steering wheel.
- If you attach objects to the steering wheel, the hands-off warning may not work properly.

Information

- For more details on setting the functions in the infotainment system, refer to “Vehicle Settings” section in chapter 4.
- When lane markings (or road edges) are detected, the lane lines on the cluster will change from grey to white and the green  indicator light will illuminate.
- When the lane markings (or road edges) are detected and Highway Lane Change Assist is on, the lane lines on the cluster may change to green.

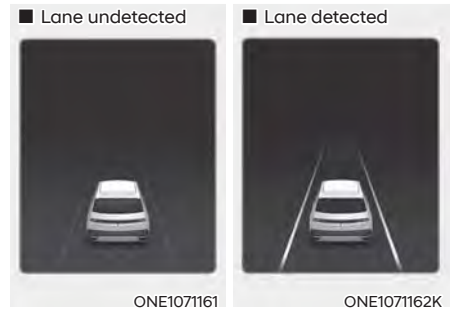

- The images and colors in the instrument cluster may differ depending on the cluster type or theme selected from the instrument cluster.
- Even though the steering is assisted by Lane Keeping Assist, the driver may control the steering wheel.
- The steering wheel may feel heavier or lighter when the steering wheel is assisted by Lane Keeping Assist than when it is not.

Information

The images or colors may be displayed differently depending on the specifications of the instrument panel or theme.

Lane Keeping Assist Malfunction and Limitations

Lane Keeping Assist malfunction



When Lane Keeping Assist is not working properly, the 'Check Lane Safety system' warning message will appear and the yellow  indicator light will illuminate on the cluster. If this occurs, have the vehicle be inspected by an authorized HYUNDAI dealer.

Limitations of Lane Keeping Assist

Lane Keeping Assist may not operate properly or may operate unexpectedly under the following circumstances:

- The lane is contaminated or difficult to detect because:
 - The lane markings (or road edge) are covered with rain, snow, dirt, oil, etc.
 - The color of the lane marking (or road edge) is not distinguishable from the road

- There are markings (or road edges) on the road near the lane or the markings (or road edges) on the road look similar to the lane markings (or road edge)
- The lane marking (or road edge) is indistinct or damaged
- The shadow is on the lane marking (or road edge) by a median strip, trees, guardrail, noise barriers, etc.
- The number of lanes change or the lanes merge
- There are more than two lane markings (or road edges) on the road
- The lane markings (or road edges) are complicated or a structure substitutes for the lines, such as a construction area
- There are road markings, such as zigzag lanes, crosswalk markings and road signs
- The lane suddenly disappears, such as at the intersection
- The lane (or road width) is very wide or narrow
- There is a road edge without a lane
- There is a boundary structure in the roadway, such as a tollgate, sidewalk, curb, etc.
- The distance to the front vehicle is extremely short or the vehicle in front is covering the lane marking (or road edge)

Information

For more details on the limitations of the front view camera, refer to “Forward Collision-Avoidance Assist (FCA)” section in this chapter.



WARNING

Take the following precautions when using Lane Keeping Assist:

- The driver should hold the responsibility to safely drive and control the vehicle. Do not solely rely on Lane Keeping Assist and drive dangerously.
 - The operation of Lane Keeping Assist can be canceled or not work properly depending on road conditions and surroundings. Always be cautious while driving.
 - Refer to “Limitations of Lane Keeping Assist” if the lane is not detected properly.
 - When you are towing a trailer or another vehicle, turn off Lane Keeping Assist for safety reasons.
 - If the vehicle is driven at high speed, the steering wheel will not be controlled. The driver must always follow the speed limit when using Lane Keeping Assist.
 - If any other system’s warning message is displayed or audible warning is generated, Lane Keeping Assist warning message may not be displayed and audible warning may not be generated.
- You may not hear the warning sound of Lane Keeping Assist if the surrounding is noisy.
 - If you attach objects to the steering wheel, steering may not be assisted properly.
 - Lane Keeping Assist may not operate for 15 seconds after the vehicle is started, or the front view camera is initialized.
 - Lane Keeping Assist will not operate when:
 - The turn signal or hazard warning flasher is turned on.
 - The vehicle is not driven in the center of the lane when Lane Keeping Assist is turned on or right after changing a lane.
 - ESC (Electronic Stability Control) or VSM (Vehicle Stability Management) is activated.
 - The vehicle is driven on a sharp curve.
 - Vehicle speed is below 35 mph (55 km/h) or above 130 mph (210 km/h).
 - The vehicle makes sharp lane changes.
 - The vehicle brakes suddenly.

BLIND-SPOT COLLISION-AVOIDANCE ASSIST (BCA) (IF EQUIPPED)

Blind-Spot Collision-Avoidance Assist is designed to help detect and monitor approaching vehicles in the driver's blind spot area and warn the driver of a possible collision with a warning message and audible warning.

In addition, if there is a risk of collision when changing lanes or driving forward out of a parking space, Blind-Spot Collision-Avoidance Assist will help avoid collision by applying the brake.

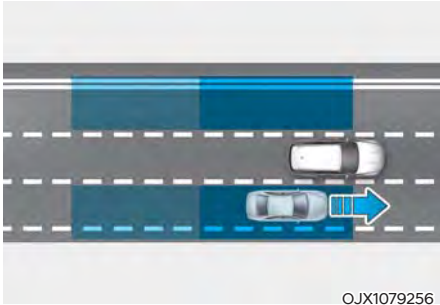

OJX1079256

Blind-Spot Collision-Avoidance Assist helps detect and informs the driver that a vehicle is in the blind spot.

CAUTION

The detecting range may vary depending on the speed of your vehicle. Even if there is a vehicle in the blind spot area, Blind-Spot Collision-Avoidance Assist may not warn you when you pass by at high speeds.

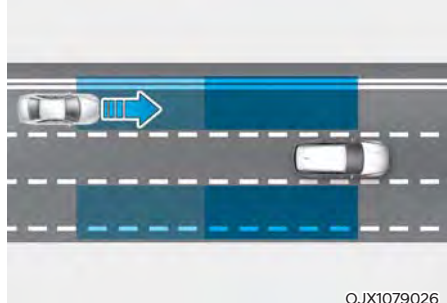

OJX1079026

Blind-Spot Collision-Avoidance Assist helps detect and informs the driver that a vehicle is approaching at high speed from the blind spot area.

CAUTION

Warning timing may vary depending on the speed of the vehicle approaching at high speed.

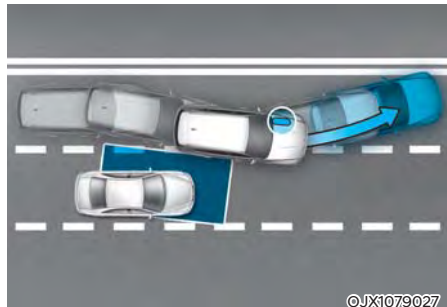

OJX1079027

When changing lanes by detecting the lane ahead, if Blind-Spot Collision-Avoidance Assist judges that there is a collision risk with an approaching vehicle in the blind spot, it will help avoid collision by applying the brake.

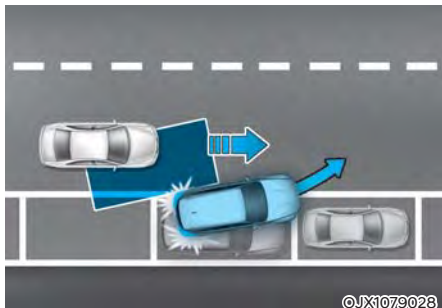

When you are driving forward out of a parking space, if Blind-Spot Collision-Avoidance Assist judges that there is a collision risk with an approaching vehicle in the blind spot, it helps avoid collision by applying the brake.

Detecting sensor



[1] : Front view camera, [2] : Rear corner radar

Refer to the picture above for the detailed location of the detecting sensors.

CAUTION

Take the following precautions to maintain optimal performance of the detecting sensor:

- Never disassemble the rear corner radar or radar assembly, or cause any damage to it.
- If the rear corner radar or near the radar has been damaged or impacted in any way, even though the warning message does not appear on the cluster, Blind-Spot Collision-Avoidance Assist system may not operate properly. Have the vehicle be inspected by an authorized HYUNDAI dealer.

- If the rear corner radars have been replaced or repaired, have the vehicle be inspected by an authorized HYUNDAI dealer.
- Use only genuine parts to repair the rear bumper where the rear corner radar is located.
- Do not apply license plate frame or objects, such as a bumper sticker, film or a bumper guard near the rear corner radar.
- **Blind-Spot Collision-Avoidance Assist may not work properly if the bumper have been replaced, or the surroundings of the rear corner radar has been damaged or paint has been applied.**
- If a trailer, carrier, etc., is installed, it may adversely affect the performance of the rear corner radar or **Blind-Spot Collision-Avoidance Assist may not operate.**
- For more details on the precautions of the front view camera, refer to “Forward Collision-Avoidance Assist (FCA)” section in this chapter.

Blind-Spot Collision-Avoidance Assist Settings

Setting features

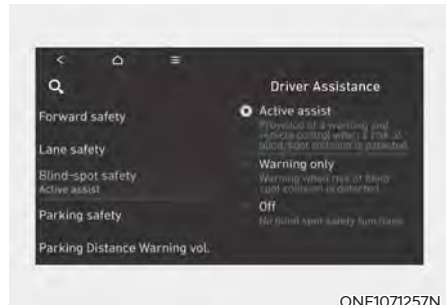

Blind-Spot Safety

With the vehicle on, select or deselect ‘Driver Assistance → Blind-Spot Safety’ from the Settings menu to set whether to use each function.

- If ‘Active Assist’ is selected, Blind-Spot Collision-Avoidance Assist will warn the driver with a warning message, an audible warning depending on the collision risk levels. Braking assist will be applied depending on the collision risk levels.
- If ‘Warning Only’ is selected, Blind-Spot Collision-Avoidance Assist will warn the driver with a warning message, an audible warning depending on the collision risk levels. Braking will not be assisted.
- If ‘Off’ is selected, Blind-Spot Collision-Avoidance Assist will turn off.



OTM070097N

When the vehicle is restarted with Blind-Spot Collision-Avoidance Assist off, the 'Blind-Spot Safety System is Off' message will appear on the cluster.

If you change the setting from 'Off' to 'Active Assist' or 'Warning Only', the warning light on the side view mirror will blink for three seconds.

In addition, if the vehicle is turned on, when Blind-Spot Collision-Avoidance Assist is set to 'Active Assist' or 'Warning Only', the warning light on the side view mirror will blink for three seconds.

WARNING

- If 'Warning Only' is selected, braking is not assisted.
- If 'Off' is selected, the driver should always be aware of the surroundings and drive safely.

Information

If the vehicle is restarted, Blind-Spot Collision-Avoidance Assist will maintain the last setting.

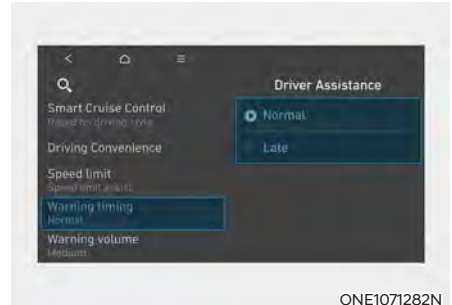

ONE1071282N

Warning Timing

With the vehicle on, select 'Driver Assistance → Warning Timing' from the Settings menu to change the initial warning activation time for Blind-Spot Collision-Avoidance Assist.

When the vehicle is first delivered, Warning Timing is set to 'Normal'. If you change the Warning Timing, the Warning Timing of other Driver Assistance systems may change.

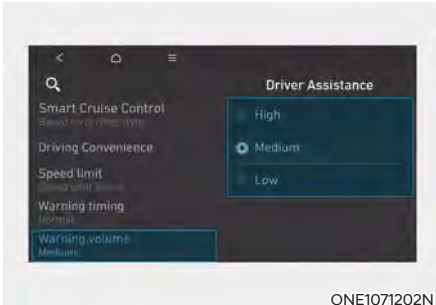

Warning Volume

With the vehicle on, select 'Driver Assistance → Warning Volume' from the Settings menu to change the Warning Volume to 'High', 'Medium' or 'Low' for Blind-Spot Collision-Avoidance Assist.

If you change the warning volume, the Warning Volume of other Driver Assistance systems may change.



CAUTION

- **The setting of the Warning Timing and Warning Volume applies to all functions of Blind-Spot Collision-Avoidance Assist.**
- **Even though 'Normal' is selected for Warning Timing, if a vehicle approaches at high speed, the warning may seem late.**
- **Select 'Late' for Warning Timing when traffic is light and when driving speed is slow.**

Blind-Spot Collision-Avoidance Assist Operation

Warning and control



Vehicle detection

- To warn the driver a vehicle is detected, the warning light on the side view mirror and head-up display (if equipped) will illuminate.
- Blind-Spot Collision-Avoidance Assist will operate when your vehicle speed is above 12 mph (20 km/h) and the speed of the vehicle in the blind spot area is above 7 mph (10 km/h).

Collision warning

- Collision warning will operate when the turn signal is turned on in the direction of the detected vehicle.
- If 'Warning Only' is selected from the Settings menu, the collision warning will operate when your vehicle approaches the lane the blind spot vehicle is detected.
- To warn the driver of a collision, the warning light on the outside side view mirror and head-up display (if equipped) will blink. At the same time, an audible warning will sound.
- When the turn signal is turned off or you move away from the lane, the collision warning will be canceled and Blind-Spot Collision-Avoidance Assist will return to vehicle detection state.



WARNING

- **The detecting range of the rear corner radar is determined by a standard road width, therefore, on a narrow road, Blind-Spot Collision-Avoidance Assist may detect other vehicles two lanes over and warn you. In contrast, on a wide road, Blind-Spot Collision-Avoidance Assist may not be able to detect a vehicle driving in the next lane and may not warn you.**
- **When the hazard warning flasher is on, the collision warning by the turn signal will not operate.**

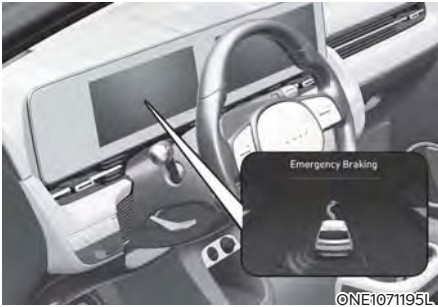

Collision-avoidance assist (while driving)

- To warn the driver of a collision, the warning light on the side view mirror will blink and a warning message will appear on the cluster. At the same time, an audible warning will sound, warning light on the head-up display (if equipped) will blink.
- Blind-Spot Collision-Avoidance Assist will operate when your vehicle speed is between 40 - 120 mph (60 - 200 km/h) and both lane markings of the driving lane are detected.
- Emergency braking will be assisted to help prevent collision with the vehicle in the blind spot area.

WARNING

- **Collision-Avoidance Assist will be canceled under the following circumstances:**
 - Your vehicle enters the next lane by a certain distance
 - Your vehicle is away from the collision risk
 - The steering wheel is sharply steered
 - The brake pedal is depressed
 - Forward Collision-Avoidance Assist is operating
- **After Blind-Spot Collision-Avoidance Assist operation or changing lane, you must drive to the center of the lane. Blind-Spot Collision-Avoidance Assist will not operate if the vehicle is not driven in the center of the lane.**



Collision-avoidance assist (while departing)

- To warn the driver of a collision, the warning light on the side view mirror will blink and a warning message will appear on the cluster. At the same time, an audible warning will sound, warning light on the head-up display (if equipped) will blink.
- Blind-Spot Collision-Avoidance Assist will operate when your vehicle speed is below 2 mph (3 km/h) and the speed of the vehicle in the blind spot area is above 3 mph (5 km/h).
- Emergency braking will be assisted to help prevent collision with the vehicle in the blind spot area.



- When the vehicle is stopped due to emergency braking, the 'Drive carefully' warning message will appear on the cluster.
For your safety, the driver should depress the brake pedal immediately and check the surroundings.
- Brake control will end after the vehicle is stopped by emergency braking for approximately 2 seconds.



WARNING

Take the following precautions when using Blind-Spot Collision-Avoidance Assist:

- For your safety, change the Settings after parking the vehicle at a safe location.
- If any other system's warning message is displayed or audible warning is generated, Blind-Spot Collision-Avoidance Assist's warning message may not be displayed and audible warning may not be generated.
- You may not hear the warning sound of Blind-Spot Collision-Avoidance Assist if the surrounding is noisy.
- Blind-Spot Collision-Avoidance Assist may not operate if the driver applies the brake pedal to avoid collision.
- When Blind-Spot Collision-Avoidance Assist is operating, braking control by the system will automatically cancel when the driver excessively depresses the accelerator pedal or sharply steers the vehicle.
- During Blind-Spot Collision-Avoidance Assist operation, the vehicle may stop suddenly injuring passengers and shifting loose objects. Always have the seat belt on and keep loose objects secured.
- Even if there is a problem with Blind-Spot Collision-Avoidance Assist, the vehicle's basic braking performance will operate properly.
- Blind-Spot Collision-Avoidance Assist does not operate in all situations or cannot avoid all collisions.

- Blind-Spot Collision-Avoidance Assist may warn the driver late or may not warn the driver depending on the road and driving conditions.
- Driver should maintain control of the vehicle at all times. Do not depend on Blind-Spot Collision-Avoidance Assist. Maintain a safe braking distance, and if necessary, depress the brake pedal to reduce driving speed or to stop the vehicle.
- Never operate Blind-Spot Collision-Avoidance Assist on people, animal, objects, etc. It may cause serious injury or death.



WARNING

The brake control may not operate properly depending on the status of ESC (Electronic Stability Control).

There will only be a warning when:

- The ESC (Electronic Stability Control) warning light is on
- ESC (Electronic Stability Control) is engaged in a different function



Information

The images or colors may be displayed differently depending on the specifications of the instrument panel or theme.

Blind-Spot Collision-Avoidance Assist Malfunction and Limitations

Blind-Spot Collision-Avoidance Assist malfunction

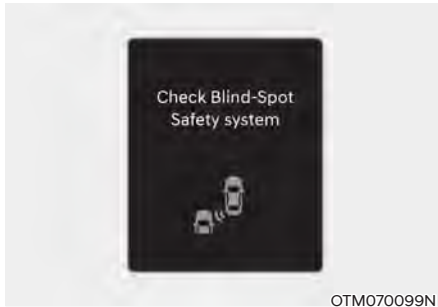

OTM070099N

When Blind-Spot Collision-Avoidance Assist is not working properly, the 'Check Blind-Spot Safety system' warning message will appear on the cluster for several seconds, and the master (⚠) warning light will illuminate on the cluster. If this occurs, have the vehicle inspected by an authorized HYUNDAI dealer.

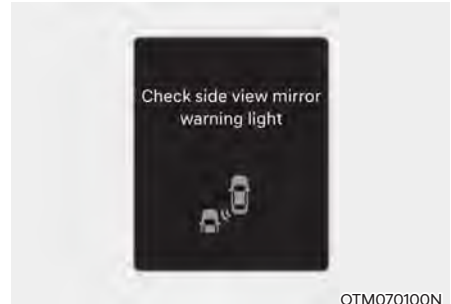

OTM070100N

When the side view mirror warning light is not working properly, the 'Check side view mirror warning light' (or 'Check outside mirror warning icon') warning message will appear on the cluster for several seconds, and the master (⚠) warning light will illuminate on the cluster. If this occurs, have the vehicle be inspected by an authorized HYUNDAI dealer.

Blind-Spot Collision-Avoidance Assist disabled



When the rear bumper around the rear corner radar or sensor is covered with foreign material, such as snow or rain, or installing a trailer or carrier, it can reduce the detecting performance and temporarily limit or disable Blind-Spot Collision-Avoidance Assist.

If this occurs, the 'Blind-Spot Safety system disabled. Radar blocked' warning message will appear on the cluster.

Blind-Spot Collision-Avoidance Assist will operate properly when such foreign material or trailer, etc., is removed, and then the vehicle is restarted.

If Blind-Spot Collision-Avoidance Assist does not operate properly after it is removed, have the vehicle inspected by an authorized HYUNDAI dealer.

WARNING

- Even though the warning message does not appear on the cluster, Blind-Spot Collision-Avoidance Assist may not properly operate.
- Blind-Spot Collision-Avoidance Assist may not properly operate in an area (for example, open terrain) where any objects are not detected right after the vehicle is turned on, or when the detecting sensor is blocked with foreign material right after the vehicle is turned on.

CAUTION

Turn off Blind-Spot Collision-Avoidance Assist to install or remove a trailer, carrier, or another attachment. Turn on Blind-Spot Collision-Avoidance Assist when finished.

Limitations of Blind-Spot Collision-Avoidance Assist

Blind-Spot Collision-Avoidance Assist may not operate properly, or Blind-Spot Collision-Avoidance Assist may operate unexpectedly under the following circumstances:

- There is inclement weather, such as heavy snow, heavy rain, etc.
- The rear corner radar is covered with snow, rain, dirt, etc.
- The temperature around the rear corner radar is high or low
- Driving on a highway ramp
- The road pavement (or the peripheral ground) abnormally contains metallic components (for example, possibly due to subway construction)

- There is a fixed object near the vehicle, such as sound barriers, guardrails, central dividers, entry barriers, street lamps, signs, tunnels, walls, etc. (including double structures)
- Driving in vast areas where there are few vehicles or structures (for example, desert, meadow, suburb, etc.)
- Driving through a narrow road where trees or grass are overgrown
- Driving on a wet road surface, such as a puddle on the road
- The other vehicle drives very close behind your vehicle, or the other vehicle passes by your vehicle in close proximity
- The speed of the other vehicle is very fast that it passes by your vehicle in a short time
- Your vehicle passes by the other vehicle
- Your vehicle changes lane
- Your vehicle has started at the same time as the vehicle next to you and has accelerated
- The vehicle in the next lane moves two lanes away from you, or when the vehicle two lanes away moves to the next lane from you
- A trailer or carrier is installed around the rear corner radar
- The bumper around the rear corner radar is covered with objects, such as a bumper sticker, bumper guard, bike rack, etc.
- The bumper around the rear corner radar is impacted, damaged or the radar is out of position
- Your vehicle height is low or high due to heavy loads, abnormal tire pressure, etc.

Blind-Spot Collision-Avoidance Assist may not operate properly, or it may operate unexpectedly when the following objects are detected:

- A motorcycle or bicycle is detected
- A vehicle such as a flat trailer is detected
- A big vehicle such as a bus or truck is detected
- A moving obstacle such as a pedestrian, animal, shopping cart or a baby stroller is detected
- A vehicle with low height such as a sports car is detected

Braking control may not work, driver's attention is required in the following circumstances:

- The vehicle severely vibrates while driving over a bumpy road, uneven road or concrete patch
- Driving on a slippery surface due to snow, water puddle, ice, etc.
- The tire pressure is low or a tire is damaged
- The braking system has been modified
- The vehicle makes abrupt lane changes

Information

For more details on the limitations of the front view camera, refer to “Forward Collision-Avoidance Assist (FCA)” and “Lane Keeping Assist (LKA)” section in this chapter.

 **WARNING**

- Driving on a curved road

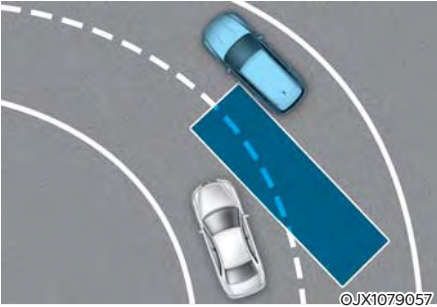

Blind-Spot Collision-Avoidance Assist may not operate properly when driving on a curved road. The function may not detect the vehicle in the next lane.

Always pay attention to road and driving conditions while driving.

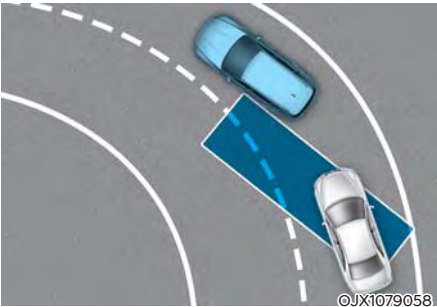

Blind-Spot Collision-Avoidance Assist may not operate properly when driving on a curved road. The function may recognize a vehicle in the same lane.

Always pay attention to road and driving conditions while driving.

- Driving where the road is merging/dividing

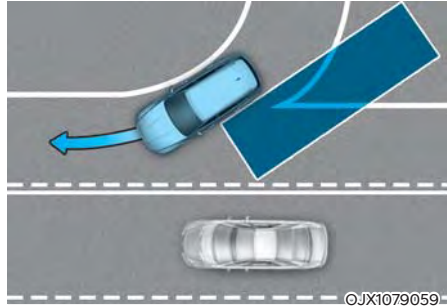

Blind-Spot Collision-Avoidance Assist may not operate properly when driving where the road merges or divides. The function may not detect the vehicle in the next lane.

Always pay attention to road and driving conditions while driving.

- Driving on a sloped road

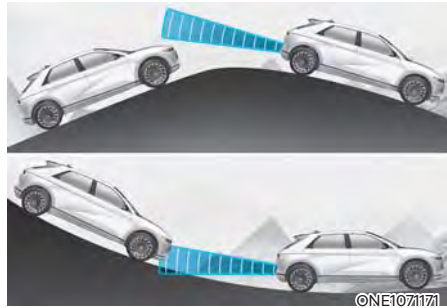

Blind-Spot Collision-Avoidance Assist may not operate properly when driving on a slope. The function may not detect the vehicle in the next lane or may incorrectly detect the ground or structure.

Always pay attention to road and driving conditions while driving.

- Driving where the heights of the lanes are different

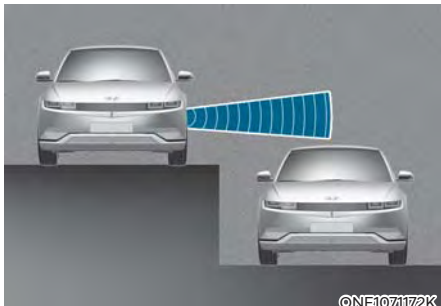

Blind-Spot Collision-Avoidance Assist may not operate properly when driving where the heights of the lanes are different. The function may not detect the vehicle on a road with different lane heights (underpass joining section, grade separated intersections, etc.).

Always pay attention to road and driving conditions while driving.

WARNING

- When you are towing a trailer or another vehicle, make sure that you turn off Blind-Spot Collision-Avoidance Assist.
- Blind-Spot Collision-Avoidance Assist may not operate properly if interfered by strong electromagnetic waves.
- Blind-Spot Collision-Avoidance Assist may not operate for 15 seconds after the vehicle is started, or the front view camera or rear corner radars are initialized.

Information

This device complies with Part 15 of the FCC rules.

Operation is subject to the following three conditions:

1. This device may not cause harmful interference, and
2. This device must accept any interference received, including interference that may cause undesired operation of the device.
3. Changes or modifications not expressly approved by the party responsible for compliance could void the user's authority to operate the device.

Information

Radio frequency radiation exposure information:

This equipment complies with FCC radiation exposure limits set forth for an uncontrolled environment.

This equipment should be installed and operated with minimum distance of 8 in. (20 cm) between the radiator (antenna) and your body.

This transmitter must not be co-located or operating in conjunction with any other antenna or transmitter.

SAFE EXIT ASSIST (SEA) (IF EQUIPPED)

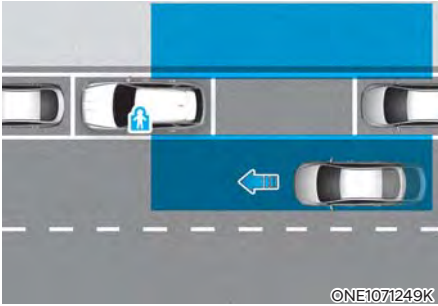

After the vehicle stops, when an approaching vehicle from the rear area is detected after a passenger opens the door, Safe Exit Assist will warn the driver with a warning message and an audible warning to help prevent a collision.



In addition, when the electronic child safety lock button is in the LOCK position and an approaching vehicle from the rear area is detected, the electronic child safety lock button will not unlock even if the driver presses the button to prevent the rear doors from opening.

CAUTION

Warning timing may vary depending on the speed of the approaching vehicle.

Detecting sensor



[1] : Rear corner radar

Refer to the picture above for the detailed location of the detecting sensors.

CAUTION

For more details on the precautions of the rear corner radars, refer to “Blind-Spot Collision-Avoidance Assist (BCA)” section in this chapter.

Safe Exit Assist Settings

Setting features

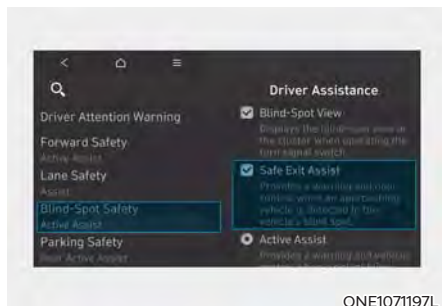

Safe Exit Assist

With the vehicle on, select 'Driver Assistance → Blind-Spot Safety → Safe Exit Assist' from the Settings menu to turn on Safe Exit Assist and deselect to turn off the function.



WARNING

The driver should always be aware of his or her surroundings. If 'Safe Exit Assist' is deselected, Safe Exit Assist cannot assist you.



Information

If the vehicle is restarted, Safe Exit Assist will maintain the last setting.

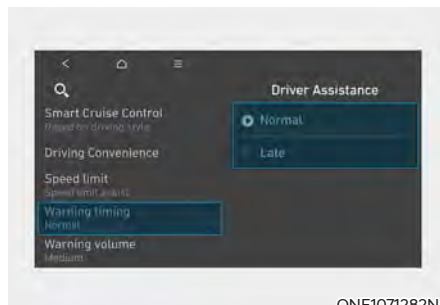

Warning Timing

With the vehicle on, select 'Driver Assistance → Warning Timing' from the Settings menu to change the initial warning activation time for Safe Exit Assist.

When the vehicle is first delivered, Warning Timing is set to 'Normal'. If you change the Warning Timing, the Warning Timing of other Driver Assistance systems may change.



Warning Volume

With the vehicle on, select 'Driver Assistance → Warning Volume' from the Settings menu to change the Warning Volume to 'High', 'Medium' or 'Low' for Safe Exit Assist.

If you change the warning volume, the Warning Volume of other Driver Assistance systems may change.



CAUTION

- The setting of the Warning Timing and Warning Volume applies to all functions of the Safe Exit Assist.
- Even though 'Normal' is selected for Warning Timing, if a vehicle approaches at high speed from the rear, the warning may seem late.
- Select 'Late' for Warning Timing when traffic is light and driving speed is slow.

Safe Exit Assist Operation

Warning and control



Collision warning when exiting vehicle

- When an approaching vehicle from the rear is detected at the moment a door is opened, the 'Watch for traffic' warning message will appear on the cluster, and an audible warning will sound.
- Safe Exit Assist will warn the driver when your vehicle speed is below 2 mph (3 km/h), and the speed of the approaching vehicle from the rear is above 4 mph (6 km/h).



Safe Exit Assist linked with Electronic child safety lock

- When Electric child safety lock is operating and an approaching vehicle from the rear area is detected, the rear doors cannot be unlocked even if the driver tries to unlock the rear doors using the electronic child safety lock button. The warning light on the side view mirror will blink and the ‘Check surroundings then try again’ warning message will appear on the cluster.
- Safe Exit Assist will warn the driver when vehicle speed is below 2 mph (3 km/h) and the speed of the approaching vehicle from the rear is above 4 mph (6 km/h).
- For more details on electric child safety lock button, refer to “Electronic Child Safety Lock” section in chapter 5.



CAUTION

If the driver presses the electronic child lock button again within 10 seconds after the warning message appears, Safe Exit Assist judges that the driver has unlocked the doors acknowledging the rear status. The electronic child safety lock will turn off (button indicator OFF) and the rear doors will unlock. Always check the surroundings before turning off the electronic child safety lock button.



Information

If a rear door is opened from the outside, it will open regardless of Safe Exit Assist operation.



WARNING

Take the following precautions when using Safe Exit Assist:

- For your safety, change the Settings after parking the vehicle at a safe location.
- If any other system’s warning message is displayed or audible warning is generated, Safe Exit Assist warning message may not be displayed and audible warning may not be generated.
- You may not hear the warning sound of Safe Exit Assist if the surrounding is noisy.
- Safe Exit Assist does not operate in all situations or cannot prevent all collisions.

- Safe Exit Assist may warn the driver late or may not warn the driver depending on the road and driving conditions. Always check vehicle surroundings.
- The driver and passengers are responsible for accidents that occurs while exiting the vehicle. Always check the surroundings before you exit the vehicle.
- Never deliberately operate Safe Exit Assist. Doing so may lead to serious injury or death.
- Safe Exit Assist does not operate if there is a problem with Blind-Spot Collision-Avoidance Assist. The warning message of Blind-Spot Collision-Avoidance Assist will appear when:
 - Blind-Spot Collision-Avoidance Assist sensor or the sensor surrounding is polluted or covered
 - Blind-Spot Collision-Avoidance Assist fails to warn passengers or falsely warn passengers

i Information

After the vehicle is turned off, Safe Exit Assist operates approximately for 3 minutes, but turns off immediately if the doors are locked.

i Information

The images or colors may be displayed differently depending on the specifications of the instrument panel or theme.

Safe Exit Assist Malfunction and Limitations

Safe Exit Assist malfunction

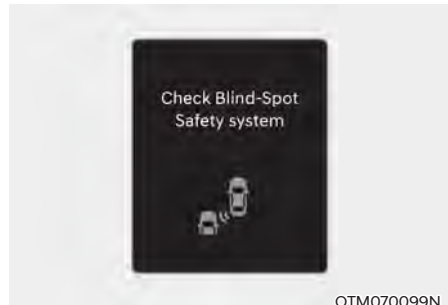

When Safe Exit Assist is not working properly, the 'Check Blind-Spot Safety system' warning message will appear on the cluster for several seconds, and the master (⚠) warning light will illuminate on the cluster. If it occurs, have the vehicle be inspected by an authorized HYUNDAI dealer.



OTM070100N

When the side view mirror warning light is not working properly, the 'Check side view mirror warning light' (or 'Check outside mirror warning icon') warning message will appear on the cluster for several seconds, and the master (⚠) warning light will illuminate on the cluster. If it occurs, have the vehicle be inspected by an authorized HYUNDAI dealer.

Safe Exit Assist disabled

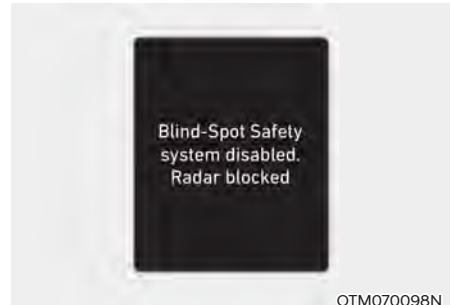

OTM070098N

When the rear bumper around the rear corner radar or sensor is covered with foreign material, such as snow or rain, or installing a trailer or carrier, it can reduce the detecting performance and temporarily limit or disable Safe Exit Assist.

If this occurs, the 'Blind-Spot Safety system disabled. Radar blocked' warning message will appear on the cluster.

Safe Exit Assist will operate properly when such foreign material or trailer, etc., is removed, and then the vehicle is restarted.

If Safe Exit Assist does not operate properly after it is removed, have the vehicle be inspected by an authorized HYUNDAI dealer.



WARNING

- Even though the warning message does not appear on the cluster, Safe Exit Assist may not properly operate.
- Safe Exit Assist may not properly operate in an area (for example, open terrain) where any objects are not detected right after the vehicle is turned on, or when the detecting sensor is blocked with foreign material right after the vehicle is turned on.



WARNING

- Safe Exit Assist may not operate properly if interfered by strong electromagnetic waves.
- Safe Exit Assist may not operate for 3 seconds after the vehicle is started, or the rear corner radars are initialized.



CAUTION

Turn off Safe Exit Assist to install or remove a trailer, carrier, or another attachment. Turn on Safe Exit Assist when finished.

Limitations of Safe Exit Assist

Safe Exit Assist may not operate properly, or it may operate unexpectedly under the following circumstances:

- Getting out of the vehicle where trees or grass are overgrown
- Getting out of the vehicle where the road is wet
- The approaching vehicle is very fast or very slow



Information

For more details on the limitations of the rear corner radar, refer to “Blind-Spot Collision-Avoidance Assist (BCA)” section in this chapter.

MANUAL SPEED LIMIT ASSIST (MSLA)



ONE1071107N

- (1) Speed Limit indicator
- (2) Set speed



You can set the speed limit when you do not want to drive over a specific speed. If you drive over the preset speed limit, Manual Speed Limit Assist operates (set speed limit will blink and chime will sound) until the vehicle speed returns within the speed limit.

Manual Speed Limit Assist Operation

Setting speed limit



ONE1071007

1. Press and hold Driving Assist () button at the desired speed. The Speed Limit () indicator will illuminate on the cluster.

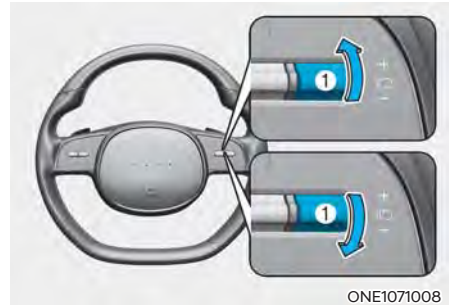

ONE1071008

2. Push the + switch (1) up or - switch (1) down, and release it at the desired speed.

Push the + switch (1) up or - switch (1) down and hold it. The speed will increase or decrease to the nearest multiple of ten (multiple of five in mph) at first, and then increase or decrease by 5 mph (10 km/h).



ONE1071108N

3. The set speed limit will be displayed on the cluster.

If you would like to drive over the preset speed limit, depress the accelerator pedal beyond the pressure point to activate the kickdown mechanism.

The set speed limit will blink and chime will sound until you return the vehicle speed within the speed limit.

i Information

When the accelerator pedal is not depressed beyond the pressure point, vehicle speed will maintain within the speed limit.

Temporarily pausing Manual Speed Limit Assist

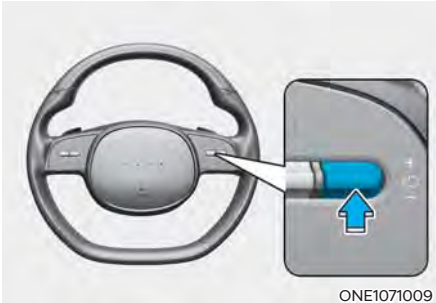

ONE1071009

Push the ||○ switch to temporarily pause the set speed limit. The set speed limit will turn off but the Speed Limit (S) LIMIT indicator will stay on.

Resuming Manual Speed Limit Assist

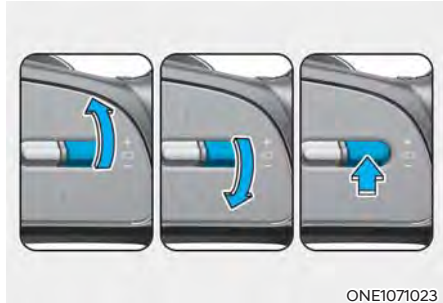

ONE1071023

To resume Manual Speed Limit Assist after the function was paused, push the +, -, ||○ switch.

If you push the + switch (1) up or - switch (1) down, vehicle speed will be set to the current speed on the cluster.

If you push the ||○ switch, vehicle speed will resume to the preset speed.

Turning off Manual Speed Limit Assist



Press the Driving Assist (🚗) button to turn Manual Speed Limit Assist off. The Speed Limit (🚗LIMIT) indicator will go off.

WARNING

Take the following precautions when using Manual Speed Limit Assist:

- Always set the vehicle speed under the speed limit in your country.
- Keep Manual Speed Limit Assist off when the function is not in use, to avoid inadvertently setting a speed. Check that the Speed Limit (🚗LIMIT) indicator is off.
- Manual Speed Limit Assist does not substitute for proper and safe driving. It is the responsibility of the driver to always drive safely and should always be aware of unexpected and sudden situations from occurring. Pay attention to the road conditions at all times.

Information

The images or colors may be displayed differently depending on the specifications of the instrument panel or theme.

INTELLIGENT SPEED LIMIT ASSIST (ISLA) (IF EQUIPPED)

Intelligent Speed Limit Assist uses information from the detected road sign and navigation system to inform the driver of the speed limit of the current road. Also, Intelligent Speed Limit Assist helps the driver to maintain within the speed limit of the road.

CAUTION

- Intelligent Speed Limit Assist may not operate properly if the function is used in other countries.
- Update your navigation regularly to ensure that Intelligent Speed Limit Assist works properly.

Detecting sensor



[1]: Front view camera

Refer to the picture above for the detailed location of the detecting sensor.

CAUTION

For more details on the precautions of the front view camera, refer to “Forward Collision-Avoidance Assist (FCA)” section in this chapter.

Information

If the navigation system is available, the information from the navigation system is used along with the road sign information detected by the front view camera.

Intelligent Speed Limit Assist Settings

Setting features

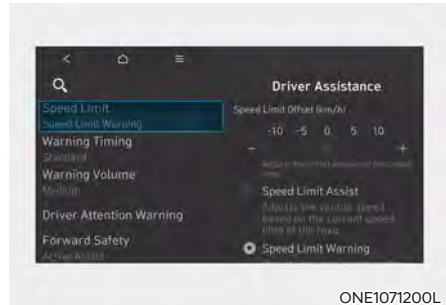

ONE1071200L

Speed Limit

With the vehicle on, select or deselect ‘Driver Assistance → Speed Limit’ from the Settings menu to set whether or not to use each function.

- If ‘Speed Limit Assist’ is selected, Intelligent Speed Limit Assist will inform the driver of speed limit. In addition, Intelligent Speed Limit Assist will inform the driver to change set speed of Manual Speed Limit Assist and/or Smart Cruise Control to help the driver stay within the speed limit.
- If ‘Speed Limit Warning’ is selected, Intelligent Speed Limit Assist will inform the driver of speed limit. In addition, Intelligent Speed Limit Assist will warn the driver when the vehicle is driven faster than the speed limit.
- If ‘Off’ is selected, Intelligent Speed Limit Assist will turn off.

CAUTION

If ‘Speed Limit Warning’ is selected, Intelligent Speed Limit Assist will not inform the driver to adjust set speed.

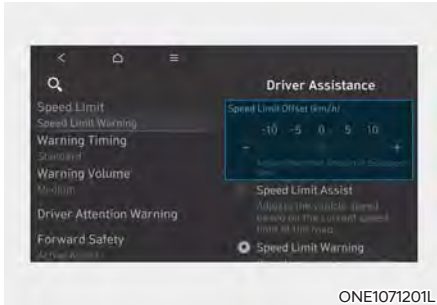

ONE1071201L

Speed Limit Offset

With the vehicle on, when 'Driver Assistance' → 'Speed Limit' → 'Speed Limit Offset' is selected, the Speed Limit Offset can be changed. Speed Limit Warning and Speed Limit Assist will operate by applying the Speed Limit Offset setting to the detected speed limit.



WARNING

- For your safety, change the Settings after parking the vehicle at a safe location.
- Speed Limit Assist function operates based on the Offset setting added to the speed limit. If you want to change the set speed according to the speed limit, adjust the offset to '0'.
- Speed Limit Warning function warns the driver when driving speed exceeds the speed at which the set Offset is added to speed limit. If you want Speed Limit Warning to warn you immediately when the driving speed exceeds the speed limit, adjust the offset to '0'.



Information

The setting of 'Speed Offset' is not reflected in Navigation-based Smart Cruise Control (NSCC).

Intelligent Speed Limit Assist Operation

Warning and control

Intelligent Speed Limit Assist will warn and control the vehicle by 'Displaying speed limit', 'Warning overspeed' and 'Changing set speed'.



Information

Intelligent Speed Limit Assist warning and control are described based on the Offset adjust to '0'. For details on Offset setting, refer to the "Intelligent Speed Limit Assist Settings".

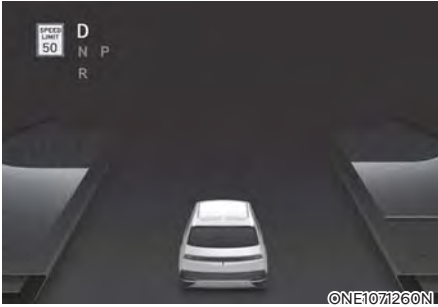

Displaying speed limit

Speed limit information is displayed on the instrument cluster.

i Information

- If speed limit information of the road cannot be recognized, '---' sign will be displayed. Please refer to "Limitations of Intelligent Speed Limit Assist" if the road signs are difficult to recognize.
- Supplementary sign displayed under the speed limit or overtaking restriction sign means the conditions under which the signs must be followed. If the supplementary sign is not recognized, it will be displayed as blank.

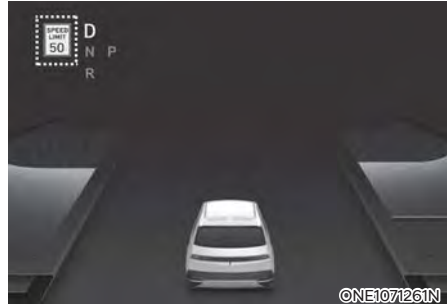

Warning overspeed

When driving at a speed higher than the displayed speed limit, the speed limit is displayed in red.



Changing set speed

If the speed limit of the road changes during the operation of Manual Speed Limit Assist or Smart Cruise Control, an arrow in the direction of up or down is displayed to inform the driver that the set speed needs to be changed. At this time, the driver can change the set speed according to the speed limit by using the + or - switch on the steering wheel.

WARNING

- If the Offset is adjusted over '0', the set speed will change to a higher speed than the speed limit of the road. If you want to drive below the speed limit, adjust the Offset under '0' or use the – switch on the steering wheel to lower the set speed.
- Even after changing the set speed according to the speed limit of the road, the vehicle can still be driven over the speed limit. If necessary, depress the brake pedal to reduce your driving speed.
- If the speed limit of the road is under 20 mph (30 km/h), the set speed change function will not work.
- Intelligent Speed Limit Assist operates using the speed unit in the instrument cluster set by the driver. If the speed unit is set to a unit other than the speed unit used in your country, Intelligent Speed Limit Assist may not operate properly.

Information

- For more details on Manual Speed Limit Assist operation, refer to “Manual Speed Limit Assist (MSLA)” section in this chapter.
- For more details on Smart Cruise Control operation, refer to “Smart Cruise Control (SCC)” section in this chapter.

Information

The images or colors may be displayed differently depending on the specifications of the instrument panel or theme.

Intelligent Speed Limit Assist Malfunction and Limitations

Intelligent Speed Limit Assist malfunction



When Intelligent Speed Limit Assist is not working properly, the 'Check speed limit system' warning message will appear on the cluster for several seconds, and the master () warning light will illuminate on the cluster. If this occurs, have the vehicle be inspected by an authorized HYUNDAI dealer.

Intelligent Speed Limit Assist disabled

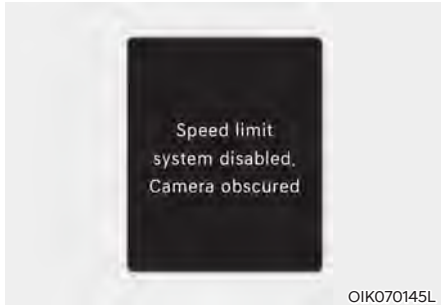

When the front windshield where the front view camera is located is covered with foreign material, such as snow or rain, it can reduce the detecting performance and temporarily limit or disable Intelligent Speed Limit Assist. If this occurs, the 'Speed limit system disabled. Camera obscured' warning message will appear on the cluster.

Intelligent Speed Limit Assist will operate properly when snow, rain or foreign material is removed.

If Intelligent Speed Limit Assist does not operate properly after it is removed, have the vehicle be inspected by an authorized HYUNDAI dealer.

WARNING

- Even though the warning message or warning light does not appear on the cluster, Intelligent Speed Limit Assist may not operate properly.
- If the detecting sensor is contaminated immediately after starting the vehicle, Intelligent Speed Limit Assist may not operate properly.

Limitations of Intelligent Speed Limit Assist

Intelligent Speed Limit Assist may not operate properly, or it may operate unexpectedly under the following circumstances:

- The road sign is contaminated or indistinguishable
 - The road sign is difficult to see due to bad weather, such as rain, snow, fog, etc.
 - The road sign is not clear or damaged
 - The road sign is partially obscured by surrounding objects or shadow
 - A road sign near the road you are driving is detected
- The road signs do not conform to the standard
 - The text or picture on the road sign is different from the standard
 - The road sign is installed between the main line and the exit road or between diverging roads
 - There is no conditional road signs on the road sign located on the exit road
 - A sign is attached to another vehicle

- The distance between the vehicle and the road signs is too far
- The vehicle encounters illuminant road signs
- Intelligent Speed Limit Assist incorrectly recognizes numbers in the street signals or other signs as the speed limit
- The minimum speed limit sign is on the road
- The brightness changes suddenly, for example when entering or exiting a tunnel or passing under a bridge
- Headlights are not used or the brightness of the headlights are weak at night or in the tunnel
- Road signs are difficult to recognize due to the reflection of sunlight, street lights, or oncoming vehicles
- The navigation information or GPS information contain errors.
- The driver does not follow the guide of the navigation.
- The driver is driving a new road that is not in the navigation system yet.
- The field of view of the front view camera is obstructed by sun glare
- Driving on a road that is sharply curved or continuously curved
- Driving through speed bumps, or driving up and down or left to right on steep inclines
- The vehicle is shaking heavily
- There is an error in the navigation map information or GPS information
- The driver is not driving along the navigation guide route
- Driving on a newly opened road

Information

For more details on the limitations of the front view camera, refer to “Forward Collision-Avoidance Assist (FCA)” section in this chapter.

WARNING

- **Intelligent Speed Limit Assist is a supplemental function that helps the driver to comply with the speed limit on the road, and may not display the correct speed limit or control the driving speed properly.**
- **Always set the vehicle speed to the speed limit in your country.**

DRIVER ATTENTION WARNING (DAW) (IF EQUIPPED)

Basic function

Driver Attention Warning can help determine the driver's attention level by analyzing driving pattern and driving time while vehicle is driven. Driver Attention Warning will recommend a break when the driver's attention level falls below a certain level.

Leading vehicle departure alert function

Leading Vehicle Departure Alert function will inform the driver when a detected vehicle in front departs from a stop.

Detecting sensor



[1]: Front view camera

The front view camera is used as a detecting sensor to help detect driving patterns and front vehicle departure while vehicle is being driven.

Refer to the picture above for the detailed location of the detecting sensor.



CAUTION

- Always keep the front view camera in good condition to maintain optimal performance of Driver Attention Warning.
- For more details on the precautions of the front view camera, refer to “Forward Collision-Avoidance Assist (FCA)” section in this chapter.

Driver Attention Warning Settings

Setting features

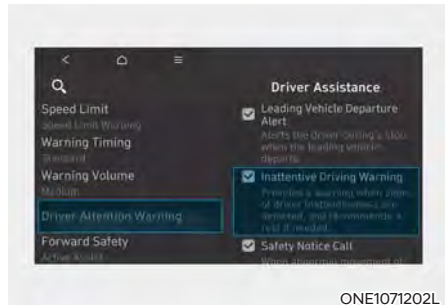

Driver Attention Warning

With the vehicle on, select or deselect ‘Driver Assistance → Driver Attention Warning’ from the Settings menu to set whether to use each function.

- If ‘Inattentive Driving Warning’ is selected, Driver Attention Warning will inform the driver the driver's attention level and will recommend taking a break when the level falls below a certain level.

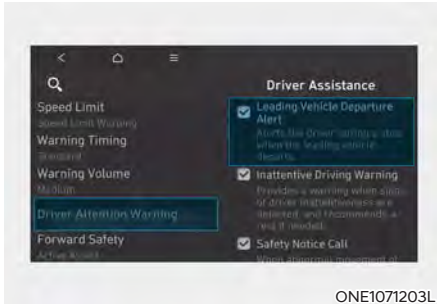

ONE1071203L

Leading Vehicle Departure Alert

- If 'Leading Vehicle Departure Alert' is selected, the function will inform the driver when the front vehicle departs from a stop.

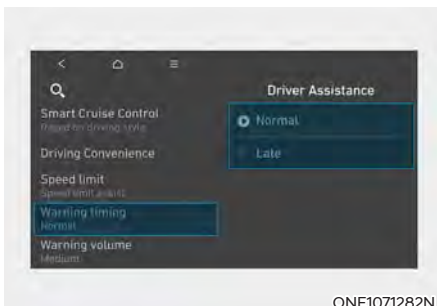

ONE1071282N

Warning Timing

With the vehicle on, select 'Driver Assistance' → 'Warning Timing' from the Settings menu to change the initial warning activation time for Driver Attention Warning.

When the vehicle is first delivered, Warning Timing is set to 'Normal'. If you change the Warning Timing, the Warning Timing of other Driver Assistance systems may change.

i Information

If the vehicle is restarted, Warning Timing will maintain the last setting.

Driver Attention Warning Operation

Basic function

Display and warning

The basic function of Driver Attention Warning is to inform the driver the 'Attention Level' and to warn the driver 'Consider taking a break'.

Attention Level



- The driver can monitor his/her driving conditions on the cluster.
 - When the 'Inattentive Driving Warning' is deselected from the Settings menu, 'System Off' is displayed.
 - Driver Attention Warning will operate when vehicle speed is between 0 - 130 mph (0 - 210 km/h).
 - When vehicle speed is not within the operating speed, the message 'Standby' will be displayed.

- The driver's attention level is displayed on the scale of 1 to 5. The lower the level is, the more inattentive the driver is.
- The level decreases when the driver does not take a break for a certain period of time.

Taking a break



- The 'Consider taking a break' message will appear on the cluster and an audible warning will sound to suggest that the driver take a break, when the driver's attention level is below 1.
- Driver Attention Warning will not suggest a break when the total driving time is shorter than 10 minutes or 10 minutes has not passed after the last break was suggested.

WARNING

For your safety, change the Settings after parking the vehicle at a safe location.

CAUTION

- Driver Attention Warning may suggest a break depending on the driver's driving pattern or habits, even if the driver doesn't feel fatigued.
- Driver Attention Warning is a supplemental function and may not be able to determine whether the driver is inattentive.
- The driver who feels fatigued should take a break at a safe location, even though there is no break suggestion by Driver Attention Warning.

Information

- For more details on setting the functions in the infotainment system, refer to "Vehicle Settings" section in chapter 4.
- Driver Attention Warning will reset the last break time to 00:00 in the following situations:
 - The vehicle is turned off
 - The driver unfastens the seat belt and opens the driver's door
 - The vehicle is stopped for more than 10 minutes
- When the driver resets Driver Attention Warning, the last break time is set to 00:00 and the driver's attention level is set to High.

Leading Vehicle Departure Alert function



When a detected vehicle in front departs from a stop, Leading Vehicle Departure Alert will inform the driver by displaying the 'Leading vehicle is driving away' message on the cluster and an audible warning will sound.

WARNING

- **If any other system's warning message is displayed or audible warning is generated, Leading Vehicle Departure Alert's warning message may not be displayed and audible warning may not be generated.**
- **The driver should hold the responsibility to safely drive and control the vehicle.**

CAUTION

- **Leading Vehicle Departure Alert is a supplemental function and may not alert the driver whenever the front vehicle departs from a stop.**
- **Always check the front of the vehicle and road conditions before departure.**

i Information

The images or colors may be displayed differently depending on the specifications of the instrument panel or theme.

Driver Attention Warning Malfunction and Limitations **Driver Attention Warning malfunction**



When Driver Attention Warning is not working properly, the 'Check Driver Attention Warning (DAW) system' warning message will appear on the cluster for several seconds, and the master (⚠) warning light will illuminate on the cluster. If this occurs, have the vehicle be inspected by an authorized HYUNDAI dealer.

Limitations of Driver Attention Warning

Driver Attention Warning may not work properly in the following situations:

- The vehicle is driven violently
- The vehicle intentionally crosses over lanes frequently
- The vehicle is controlled by Driver Assistance system, such as Lane Keeping Assist

Leading vehicle departure alert function

- When the vehicle cuts in

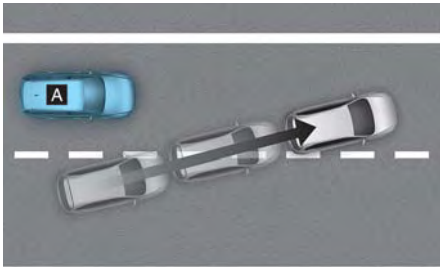

©ADAS021

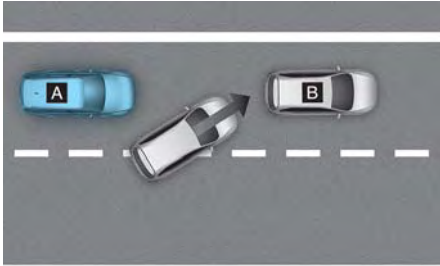

©ADAS022

[A] : Your vehicle, [B] : Front vehicle

If a vehicle cuts in front of your vehicle, Leading Departure Alert may not operate properly.

- When the vehicle ahead sharply steers

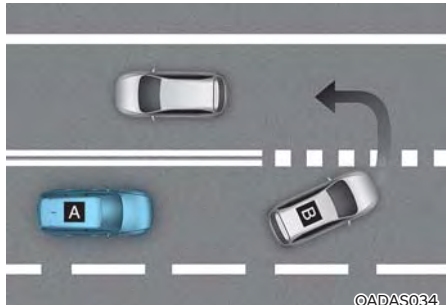

©ADAS034

[A] : Your vehicle, [B] : Front vehicle

If the vehicle in front makes a sharp turn, such as to turn left or right or make a U- turn, etc., Leading Vehicle Departure Alert may not operate properly.

- When the vehicle ahead abruptly departs

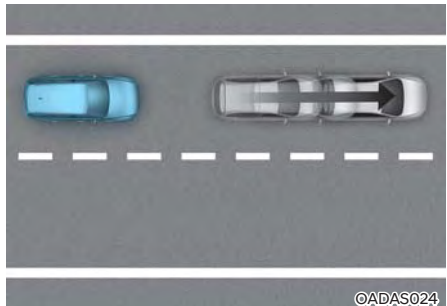

©ADAS024

If the vehicle in front abruptly departs, Leading Vehicle Departure Alert may not operate properly.

- When a pedestrian or bicycle is between you and the vehicle ahead



If there is a pedestrian(s) or bicycle(s) in between you and the vehicle in front, Leading Vehicle Departure Alert may not operate properly.

- When in a parking lot



If a vehicle parked in front drives away from you, Leading Vehicle Departure Alert may alert you that the parked vehicle is driving away.

- When driving at a tollgate or intersection, etc.

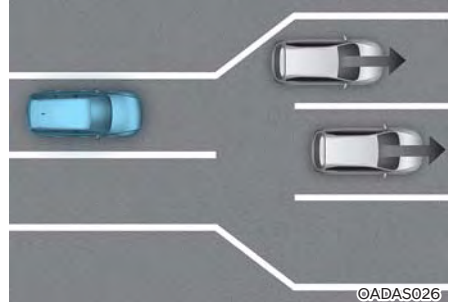

If you pass a tollgate or intersection with lots of vehicles or you drive where lanes are merged or divided frequently, Leading Vehicle Departure Alert may not operate properly.

i Information

For more details on the precautions of the front view camera, refer to “Forward Collision-Avoidance Assist (FCA)” section in this chapter.

BLIND-SPOT VIEW MONITOR (BVM) (IF EQUIPPED)

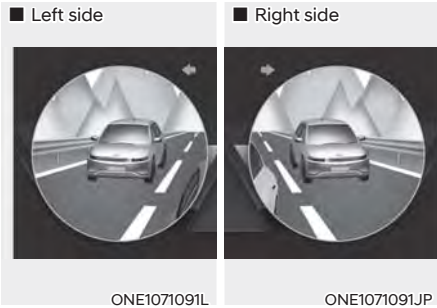

Blind-Spot View Monitor displays the rear blind spot area of the vehicle in the cluster when the turn signal is turned on to help safely change lanes.

Detecting sensor



[1], [2]: Surround-side view camera
(camera located at bottom of the mirror)

Refer to the picture above for the detailed location of the detecting sensors.

Blind-Spot View Monitor Settings

Setting features

Blind-Spot View

With the vehicle on, select 'Driver Assistance → Blind-Spot Safety → Blind-Spot View' from the Settings menu to turn on Blind-Spot View Monitor and deselect to turn off the function.

Blind-Spot View Monitor Operation

Operating switch

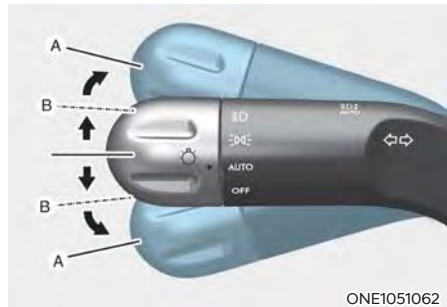

Turn signal lever

Blind-Spot View Monitor will turn on and off when the turn signal is turned on and off.

Blind-Spot View Monitor

Operating conditions

- When the turn signal turns off, the image on the instrument cluster will turn off.
- When the hazard warning flasher is on, Blind-Spot View Monitor will turn off, regardless of the turn signal status.
- When other important warning is displayed on the instrument cluster, Blind-Spot View Monitor may turn off.

Blind-Spot View Monitor Malfunction

When Blind-Spot View Monitor is not working properly, or the cluster display flickers, or the camera image does not display properly, have the vehicle be inspected by an authorized HYUNDAI dealer.



WARNING

- **The image shown on the cluster may differ from the actual distance of the object. Make sure to directly check the vehicle's surroundings for safety.**
- **Always keep the camera lens clean. If the lens is covered with foreign material, it may adversely affect camera performance and Blind-Spot View Monitor may not operate properly.**

SMART CRUISE CONTROL (SCC)

Smart Cruise Control is designed to help detect the vehicle ahead and help maintain the desired speed and minimum distance between the vehicle ahead.

Overtaking Acceleration Assist

While Smart Cruise Control is operating, if the function judges that the driver is determined to overtake the vehicle in front, acceleration will be assisted.

Based on Driving Style (if equipped)

Smart Cruise Control will operate based on the driver's driving style, such as inter-vehicle distance, acceleration, reaction speed.

Detecting sensor



[1]: Front view camera, [2]: Front radar,
[3]: Front corner radar

The front view camera and front radar are used as a detecting sensor to detect front vehicles.

Refer to the picture above for the detailed location of the detecting sensor.



CAUTION

Always keep the front view camera and front radar in good condition to maintain optimal performance of Smart Cruise Control.

For more details on the precautions of the front view camera and front radar, refer to “Forward Collision-Avoidance Assist (FCA)” section in this chapter.

Smart Cruise Control Settings

Setting features



Turning on Smart Cruise Control

- Press the Driving Assist (🚗) button to turn on Smart Cruise Control. The speed will be set to the current speed on the cluster.
- If there is no vehicle in front of you, the set speed will be maintained, but if there is a vehicle in front of you, the speed may decrease to maintain the distance to the vehicle ahead. If the vehicle ahead accelerates, your vehicle will travel at a steady cruising speed after accelerating to the set speed.

i Information

If your vehicle speed is between 0 - 20 mph (0 - 30 km/h) when you press the Driving Assist (🚗) button, the Smart Cruise Control speed will be set to 20 mph (30 km/h).



Setting vehicle distance

Each time the button is pressed, the headway changes as follows:

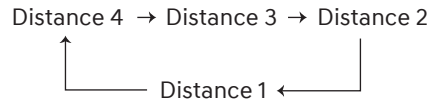

i Information

- If you drive at 56 mph (90 km/h), the distance is maintained as follows:
 - Distance 4** - approximately 172 ft. (52.5 m)
 - Distance 3** - approximately 130 ft. (40 m)
 - Distance 2** - approximately 106 ft. (32.5 m)
 - Distance 1** - approximately 82 ft. (25 m)
- The distance is set to the last set distance when the vehicle is restarted, or when Smart Cruise Control was temporarily canceled.

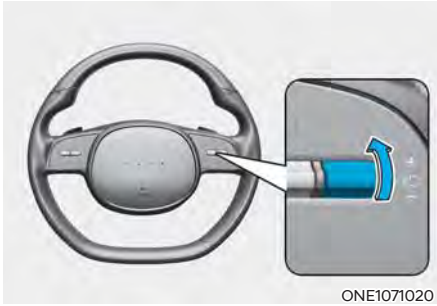

Increasing set speed

- Push the + switch up and release it immediately. The set speed will increase by 1 mph (1 km/h) each time the switch is operated in this manner.
- Push the + switch up and hold it while monitoring the set speed on the cluster. The set speed will increase by 10 km/h or 5 mph each time the switch is operated in this manner. Release the switch when the desired speed is shown, and the vehicle will accelerate to that speed. You can set the speed to 110 mph (180 km/h).

WARNING

Check the driving condition before using the + switch. Driving speed may sharply increase when you push up and hold the + switch.

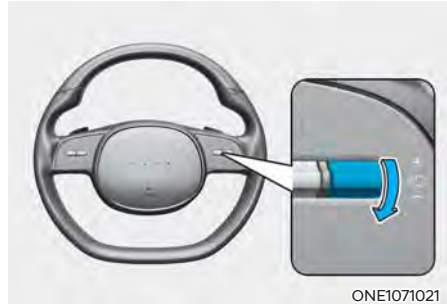

Decreasing set speed

- Push the - switch down and release it immediately. The set speed will decrease by 1 mph (1 km/h) each time the switch is operated in this manner.
- Push the - switch down and hold it while monitoring the set speed on the cluster. The set speed will decrease by 10 km/h or 5 mph each time the switch is operated in this manner. Release the switch at the speed you want to maintain. You can set the speed to 20 mph (30 km/h).

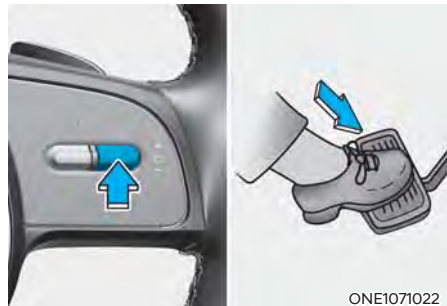

Temporarily canceling Smart Cruise Control

Press the ||○ switch or depress the brake pedal to temporarily cancel Smart Cruise Control.

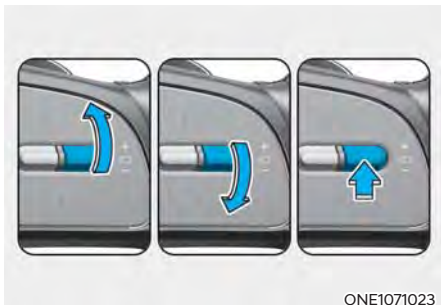

ONE1071023

Resuming Smart Cruise Control

To resume Smart Cruise Control after the function was canceled, push the +, - or ||○ switch.

If you push the + switch up or - switch down, vehicle speed will be set to the current speed on the cluster.

If you push the ||○ switch, vehicle speed will resume to the preset speed.

WARNING

Check the driving condition before using the ||○ switch. Driving speed may sharply increase or decrease when you press the ||○ switch.



ONE1071007

Turning off Smart Cruise Control

Press the Driving Assist (🚗) button to turn Smart Cruise Control off.

Information

If your vehicle is equipped with Manual Speed Limit Assist, press and hold the Driving Assist (🚗) button to turn off Smart Cruise Control. However Manual Speed Limit Assist will turn on.

Based on Drive Mode

Smart Cruise Control will change acceleration based on the drive mode selected from Drive Mode Integrated Control system. Refer to the following chart.

Drive mode	Smart Cruise Control
SNOW	Normal
ECO	Slow
SPORT	Fast
NORMAL	Normal

Information

- For more details on drive mode, refer to “Drive Mode Integrated Control System” section in chapter 6.
- Smart Cruise Control may not turn on or off in some of the drive modes for the operating conditions are not satisfied.
- If your vehicle is not equipped with Drive Mode Integrated Control system, Smart Cruise Control accelerates your vehicle at a normal level.

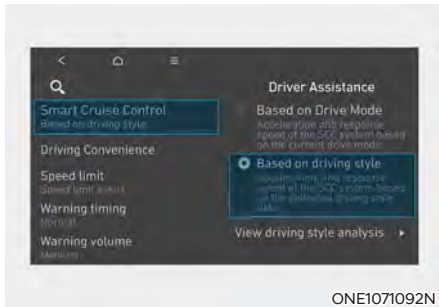

Based on Driving Style (if equipped)

- With the vehicle on, if 'Driver Assistance → Smart Cruise Control → Based on Driving Style' is selected from the Settings menu, Smart Cruise Control will operate based on the driver's driving style, such as vehicle distance, acceleration, reaction speed.
- While Smart Cruise Control is operating with 'Based on Drive Mode' selected, if you press and hold the Vehicle Distance (Ⓜ) button, Smart Cruise Control will change to 'Based on Driving Style'. While Smart Cruise Control is operating with 'Based on Driving Style', you press and hold the Vehicle Distance (Ⓜ) button, it will change to 'Based on Drive Mode'.

i Information

- **If equipped with Based on Driving Style, 'Based on Drive mode' and 'Based on Driving Style' can be selected from the settings menu by selecting 'Driver Assistance → Smart Cruise Control'.**
- **If 'Based on Drive mode' is selected, Smart Cruise Control will operate based on the drive mode selected.**



Driving Style Settings (if equipped)

With the vehicle on, select 'Driver Assistance → Smart Cruise Control → Driving Style Settings (or View driving style analysis)' from the Settings menu to check the driver's driving style, and to change each driving style manually.

i Information

- **'Driving Style Settings' (or 'View driving style analysis') is displayed when 'Based on Driving Style' is selected.**
- **Smart Cruise Control learns the driver's driving styles only when the driver drives the vehicle.**



Warning Volume

With the vehicle on, select 'Driver Assistance → Warning Volume' from the Settings menu to change the Warning Volume to 'High', 'Medium' or 'Low' for Smart Cruise Control.

If you change the warning volume, the Warning Volume of other Driver Assistance systems may change.

i Information

If the vehicle is restarted, Warning Volume will maintain the last setting.

Smart Cruise Control Operation

Operating conditions

Smart Cruise Control operates when the following conditions are satisfied.

Basic function

- The gear is in D (Drive)
- The driver's door is closed
- EPB (Electronic Parking Brake) is not applied
- Your vehicle speed is within the operating speed range
 - 5 - 110mph (10 - 180km/h): when there is no vehicle in front
 - 0 - 110mph (0 - 180km/h): when there is a vehicle in front
- ESC (Electronic Stability Control) or ABS is on
- ESC (Electronic Stability Control) or ABS is not controlling the vehicle
- Forward Collision-Avoidance Assist brake control is not operating
- Remote Smart Parking Assist brake control is not operating (if equipped)

i Information

When stopped behind another vehicle, the driver can turn on Smart Cruise Control while the brake pedal is depressed.

Overtaking Acceleration Assist

Overtaking Acceleration Assist operates when the turn signal indicator is turned on to the left while Smart Cruise Control is operating, and the following conditions are satisfied:

- Your vehicle speed is above 40 mph (60 km/h)
- The hazard warning flasher is off
- A vehicle is detected in front of your vehicle
- Deceleration is not needed to maintain distance with the vehicle in front

WARNING

- **When the turn signal indicator is turned on to the left (left-hand drive) or turned on to the right (right-hand drive) while there is a vehicle ahead, the vehicle may accelerate temporarily. Pay attention to the road conditions at all times.**
- **Regardless of your countries driving direction, Overtaking Acceleration Assist will operate when the conditions are satisfied. When using the function in countries with different driving direction, always check the road conditions at all times.**

Display and control

Basic function

You can see the status of the Smart Cruise Control operation in the Driving Assist view on the cluster. Refer to “View Modes” section in chapter 4.

Smart Cruise Control will be displayed as below depending on the status of the function.

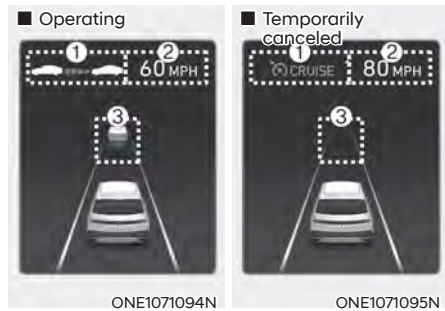

- When operating
 - (1) Whether there is a vehicle ahead and the selected distance level
 - (2) Set speed
 - (3) Whether there is a vehicle ahead and the target vehicle distance
- When temporarily canceled
 - (1)  CRUISE indicator
 - (2) The previous set speed is shaded.
 - (3) Vehicle ahead and distance level not displayed

i Information

- The distance of the front vehicle on the cluster is displayed according to the actual distance between your vehicle and the vehicle ahead.
- The target distance may vary according to the vehicle speed and the set distance level. If vehicle speed is low, even though the vehicle distance have changed, the change of the target vehicle distance may be small.
- The images and colors in the instrument cluster may differ depending on the cluster type or theme selected from the instrument cluster.



Accelerating temporarily

If you want to speed up temporarily without altering the set speed while Smart Cruise Control is operating, depress the accelerator pedal. While the accelerator pedal is depressed, the set speed, distance level and target distance will blink on the cluster.

However, if the accelerator pedal is depressed insufficiently, the vehicle may decelerate.

! WARNING

Be careful when accelerating temporarily, because the speed and distance is not controlled automatically even if there is a vehicle in front of you.



Based on Driving Style operating

When Based on Driving Style is operating, 'Driving Style Adaptive SCC' message will appear on the cluster for 2 seconds, and the distance level and target distance will be displayed based on the driving style.



OTM070113N

Smart Cruise Control temporarily canceled

Smart Cruise Control will be temporarily canceled automatically when:

- The vehicle speed is above 120mph (190km/h)
- The vehicle is stopped for a certain period of time
- The accelerator pedal is continuously depressed for a certain period of time
- The conditions for the Smart Cruise Control to operate is not satisfied

If Smart Cruise Control is temporarily canceled automatically, the 'Smart Cruise Control canceled' warning message will appear on the cluster, and an audible warning will sound to warn the driver.

If Smart Cruise Control is temporarily canceled while the vehicle is at a standstill with the function activated, EPB (Electronic Parking Brake) maybe applied.

WARNING

When Smart Cruise Control is temporarily canceled, distance with the front vehicle will not be maintained. Always have your eyes on the road while driving, and if necessary, depress the brake pedal to reduce your driving speed in order to maintain a safe distance.



OTM070112N

Smart Cruise Control conditions not satisfied

If the Driving Assist button, + switch, - switch or  switch is pushed when Smart Cruise Control operating conditions are not satisfied, the 'Smart Cruise Control conditions not met' will appear on the cluster, and an audible warning will sound.



OTM070114L

In traffic situation

In traffic, your vehicle will stop if the vehicle ahead of you stops. Also, if the vehicle ahead of you starts moving, your vehicle will start as well. In addition, after the vehicle has stopped and a certain time have passed, the 'Use switch or pedal to accelerate' message will appear on the cluster. Depress the accelerator pedal or push the + switch, - switch or ||○ switch to start driving.



ONE1071175L

Warning road conditions ahead

In the following situation, the 'Watch for surrounding vehicles' warning message will appear on the cluster, and an audible warning will sound to warn the driver of road conditions ahead.

- The vehicle in front disappears when Smart Cruise Control is maintaining the distance with the vehicle ahead while driving below a certain speed.
- While the 'Use switch or pedal to accelerate' message is displayed on the cluster, if there is no vehicle in front or the vehicle is far away from you, and the + switch, - switch or ||○ switch is pushed.



WARNING

Always pay attention to vehicles or objects that may suddenly appear in front of you, and if necessary, depress the brake pedal to reduce your driving speed in order to maintain a safe distance.



Collision Warning

While Smart Cruise Control is operating, when the collision risk with the vehicle ahead is high, the 'Collision Warning' warning message will appear on the cluster, and an audible warning will sound to warn the driver. Always have your eyes on the road while driving, and if necessary, depress the brake pedal to reduce your driving speed in order to maintain a safe distance.

WARNING

In the following situations, Smart Cruise Control may not warn the driver of a collision.

- The distance from the front vehicle is near, or the vehicle speed of the front vehicle is faster or similar with your vehicle
- The speed of the front vehicle is very slow or is at a standstill
- The accelerator pedal is depressed right after Smart Cruise Control is turned on

WARNING

Take the following precautions when using Smart Cruise Control:

- Smart Cruise Control does not substitute for proper and safe driving. It is the responsibility of the driver to always check the speed and distance to the vehicle ahead.
- Smart Cruise Control may not recognize unexpected and sudden situations or complex driving situations, so always pay attention to driving conditions and control your vehicle speed.
- Keep Smart Cruise Control off when the function is not in use to avoid inadvertently setting a speed.
- Do not open the door or leave the vehicle when Smart Cruise Control is operating, even if the vehicle is stopped.
- Always be aware of the selected speed and headway distance.
- Keep a safe distance according to road conditions and vehicle speed. If the headway distance is too close during high-speed driving, a serious collision may result.

- When maintaining distance with the vehicle ahead, if the front vehicle disappears, Smart Cruise Control may suddenly accelerate to the set speed. Always be aware of unexpected and sudden situations from occurring.
- Vehicle speed may decrease on an upward slope and increase on a downward slope.
- Always be aware of situations such as when a vehicle cuts in suddenly.
- When you are turn off Smart Cruise Control for safety reasons.
- Turn off Smart Cruise Control when your vehicle is being towed.
- Smart Cruise Control may not operate properly if interfered by strong electromagnetic waves.
- Smart Cruise Control may not detect an obstacle in front and lead to a collision. Always look ahead cautiously to prevent unexpected and sudden situations from occurring.
- Vehicles moving in front of you with a frequent lane change may cause a delay in Smart Cruise Control reaction or may cause Smart Cruise Control to react to a vehicle actually in an adjacent lane. Always drive cautiously to prevent unexpected and sudden situations from occurring.
- Always be aware of the surroundings and drive safely, even though a warning message does not appear or an audible warning does not sound.
- If any other system's warning message is displayed or warning sound is generated, Smart Cruise Control warning message may not be displayed and warning sound may not be generated.
- You may not hear the warning sound of Forward Collision-Avoidance Assist if the surrounding is noisy.
- The vehicle manufacturer is not responsible for any traffic violation or accidents caused by the driver.
- Always set the vehicle speed under the speed limit in your country.
- Vehicle distance, acceleration and reaction speed may change if the driver's driving style changes.



CAUTION

- The vehicle must be driven sufficiently to reflect the actual driving style of the driver, such as inter-vehicle distance, acceleration and reaction speed.
- Based on Driving style does not reflect whether the driver has changed when determining the driver's driving style.
- If you are driving in special conditions, such as snow, rain, fog or steep slopes, the vehicle may not be driven according to the driver's driving style.



Information

- Smart Cruise Control may not operate for 15 seconds after the vehicle is started or the front view camera or front radar is initialized.
- You may hear a sound when the brake is controlled by Smart Cruise Control.
- Based on Driving Style may not reflect the driver's driving style or driving conditions that affects driving safety.
- Based on Driving Style does not reflect any other driving style other than inter-vehicle distance, acceleration and reaction speed.
- The paddle shifter does not operate when Smart Cruise Control system is activated.



Information

The images or colors may be displayed differently depending on the specifications of the instrument panel or theme.

Smart Cruise Control Malfunction and Limitations

Smart Cruise Control malfunction



When Smart Cruise Control is not working properly, the 'Check Smart Cruise Control system' warning message will appear, and the  warning light will illuminate on the cluster. Have the vehicle be inspected by an authorized HYUNDAI dealer.

Smart Cruise Control disabled



When the front radar cover or sensor is covered with snow, rain, or foreign material, it can reduce the detecting performance and temporarily limit or disable Smart Cruise Control.

If this occurs the 'Smart Cruise Control disabled. Radar blocked' warning message will appear for a certain period of time on the cluster.

Smart Cruise Control will operate properly when snow, rain or foreign material is removed.



WARNING

Even though the warning message does not appear on the cluster, Smart Cruise Control may not properly operate.



CAUTION

Smart Cruise Control may not properly operate in an area (for example, open terrain), where any objects are not detected after turning ON the vehicle.

Limitations of Smart Cruise Control

Smart Cruise Control may not operate properly, or it may operate unexpectedly under the following circumstances:

- The detecting sensor or the surroundings are contaminated or damaged
- Washer fluid is continuously sprayed, or the wiper is on
- The camera lens is contaminated due to tinted, filmed or coated windshield, damaged glass, sticky foreign material (sticker, bug, etc.) on the glass
- Moisture is not removed or frozen on the windshield
- The field of view of the front view camera is obstructed by sun glare
- Street light or light from an oncoming traffic is reflected on the wet road surface, such as a puddle on the road
- The temperature around the front view camera is high or low due to surrounding environment
- An object is placed on the dashboard
- The surrounding is very bright
- The surrounding is very dark, such as in a tunnel, etc.
- The brightness changes suddenly, for example when entering or exiting a tunnel
- The brightness outside is low, and the headlights are not on or are not bright
- Driving in heavy rain or snow, or thick fog
- Driving through steam, smoke or shadow

- Only part of the vehicle is detected
- The vehicle in front has no tail lights, tail lights are located unusually, etc.
- The brightness outside is low, and the tail lamps are not on or are not bright
- The rear of the front vehicle is small or does not look normal (for example, tilted, overturned, etc.)
- The front vehicle's ground clearance is low or high
- A vehicle suddenly cuts in front
- Your vehicle is being towed
- Driving through a tunnel or iron bridge
- Driving near areas containing metal substances, such as a construction zone, railroad, etc.
- An object reflecting off the front radar such as a guardrail, nearby vehicle, etc.
- The bumper around the front radar is impacted, damaged or the front radar is out of position
- The temperature around the front radar is high or low
- Driving in vast areas where there are few vehicles or structures (for example, desert, meadow, suburb, etc.)
- The vehicle in front is made of material that does not reflect on the front radar
- Driving near a highway interchange or tollgate
- Driving on a slippery surface due to snow, water puddle, ice, etc.
- Driving on a curved road
- The vehicle in front is detected late
- The vehicle in front is suddenly blocked by an obstacle
- The vehicle in front suddenly changes lane or suddenly reduces speed
- The vehicle in front is bent out of shape
- The front vehicle's speed is fast or slow
- With a vehicle in front, your vehicle changes lane at low speed
- The vehicle in front is covered with snow
- Unstable driving
- You are on a roundabout and the vehicle in front is not detected
- You are continuously driving in a circle
- Driving in a parking lot
- Driving through a construction area, unpaved road, partial paved road, uneven road, speed bumps, etc.
- Driving on an incline road, curved road, etc.
- Driving through a roadside with trees or streetlights
- The adverse road conditions cause excessive vehicle vibrations while driving
- Your vehicle height is low or high due to heavy loads, abnormal tire pressure, etc.
- Driving through a narrow road where trees or grass are overgrown
- There is interference by electromagnetic waves, such as driving in an area with strong radio waves or electrical noise

- Driving on a curved road

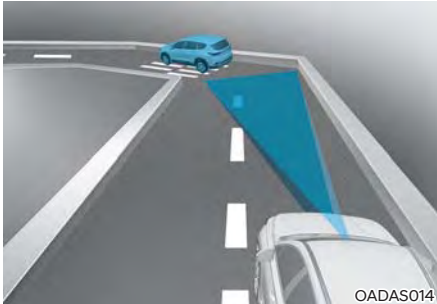

On curves, Smart Cruise Control may not detect a vehicle in the same lane, and may accelerate to the set speed. Also, vehicle speed may rapidly decrease when the vehicle ahead is detected suddenly.

Select the appropriate set speed on curves and apply the brake pedal or accelerator pedal according to the road and driving conditions ahead.



Your vehicle speed can be reduced due to a vehicle in the adjacent lane.

Apply the accelerator pedal and select the appropriate set speed. Check to be sure that the road conditions permit safe operation of the Smart Cruise Control.

- Driving on an inclined road



During uphill or downhill driving, the Smart Cruise Control may not detect a moving vehicle in your lane, and cause your vehicle to accelerate to the set speed. Also, vehicle speed will rapidly decrease when the vehicle ahead is detected suddenly.

Select the appropriate set speed on inclines and apply the brake pedal or accelerator pedal according to the road and driving conditions ahead.

- Changing lanes

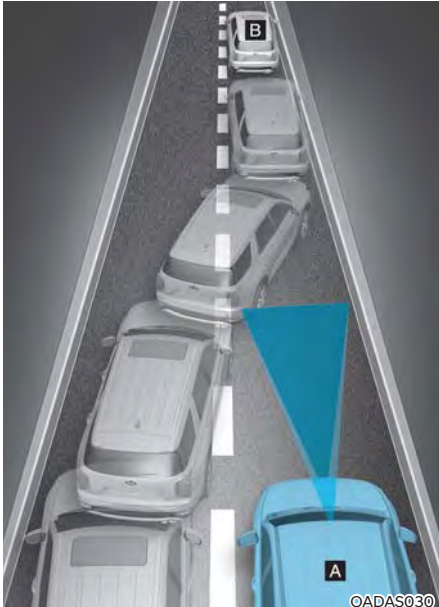

[A] : Your vehicle, [B] : Lane changing vehicle

When a vehicle moves into your lane from an adjacent lane, it cannot be detected by the sensor until it is in the sensor's detection range. Smart Cruise Control may not immediately detect the vehicle when the vehicle changes lanes abruptly. In this case, you must maintain a safe braking distance, and if necessary, depress the brake pedal to reduce your driving speed in order to maintain a safe distance.

- Detecting vehicle

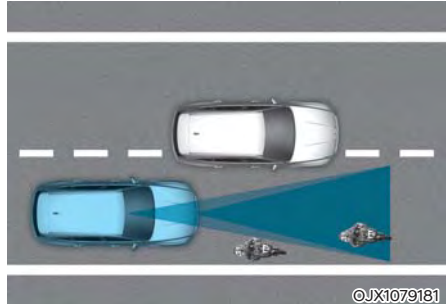

In the following cases, some vehicles in your lane cannot be detected by the sensor:

- Vehicles offset to one side
- Slow-moving vehicles or sudden-decelerating vehicles
- Oncoming vehicles
- Stopped vehicles
- Vehicles with small rear profile, such as trailers
- Narrow vehicles, such as motorcycles or bicycles
- Special vehicles
- Animals and pedestrians

Adjust your vehicle speed by depressing the brake pedal according to the road and driving conditions ahead.

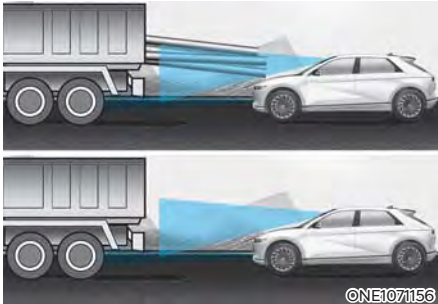

In the following cases, the vehicle in front cannot be detected by the sensor:

- Vehicles with higher ground clearance or vehicles carrying loads that stick out of the back of the vehicle
- Vehicles that has the front lifted due to heavy loads
- You are steering your vehicle
- Driving on narrow or sharply curved roads

Adjust your vehicle speed by depressing the brake pedal according to the road and driving conditions ahead.

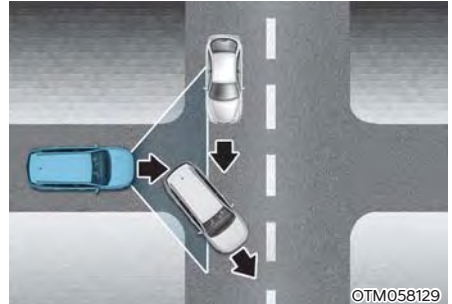

- When a vehicle ahead disappears at an intersection, your vehicle may accelerate.

Always pay attention to road and driving conditions while driving.

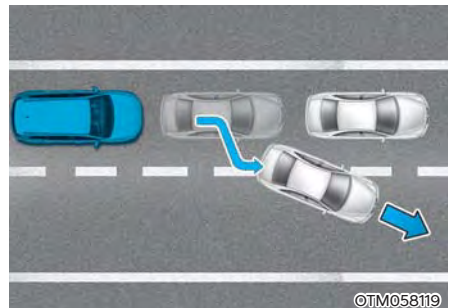

- When a vehicle in front of you merges out of the lane, Smart Cruise Control may not immediately detect the new vehicle that is now in front of you.

Always pay attention to road and driving conditions while driving.

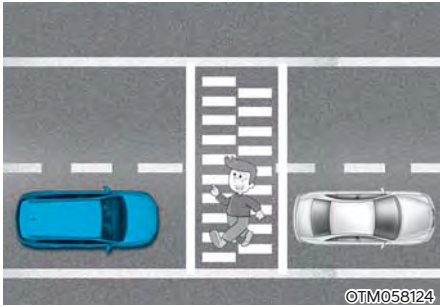

- Always look out for pedestrians when your vehicle is maintaining a distance with the vehicle ahead.

i Information

This device complies with Part 15 of the FCC rules.

Operation is subject to the following three conditions:

1. This device may not cause harmful interference, and
2. This device must accept any interference received, including interference that may cause undesired operation of the device.
3. Changes or modifications not expressly approved by the party responsible for compliance could void the user's authority to operate the device.

i Information

Radio frequency radiation exposure information:

This equipment complies with FCC radiation exposure limits set forth for an uncontrolled environment.

This equipment should be installed and operated with minimum distance of 8 in. (20 cm) between the radiator (antenna) and your body.

This transmitter must not be co-located or operating in conjunction with any other antenna or transmitter.

NAVIGATION-BASED SMART CRUISE CONTROL (NSCC) (IF EQUIPPED)

Navigation-based Smart Cruise Control can help drive at a certain speed according to the road conditions when driving on highways by using road information from the navigation system while Smart Cruise Control is operating.

i Information

- **Navigation-based Smart Cruise Control is available only on controlled access road of certain highways.**
 - * **Controlled access road indicates roads with limited entrances and exits that allow uninterrupted high speed traffic flow. Only passenger cars and motorcycles are allowed on controlled access roads.**
- **Additional highways may be expanded by future navigation updates.**

i Information

Navigation-based Smart Cruise Control operates on main roads of highways, and does not operate on interchanges or junctions.

Highway Curve Zone Auto Slowdown

If vehicle speed is high, Highway Curve Zone Auto Slowdown function will temporarily decelerate your vehicle or limit acceleration to help you drive safely on a curve based on the curve information from the navigation.

Highway Set Speed Auto Change

Highway Set Speed Auto Change function automatically changes Smart Cruise Control set speed based on the speed limit information from the navigation.

Navigation-based Smart Cruise Control Settings

Setting features

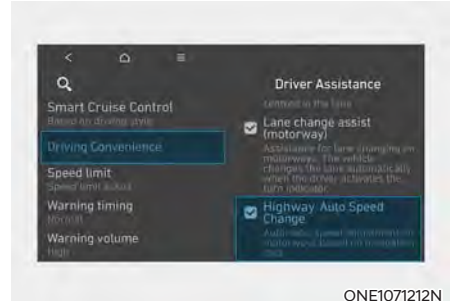

With the vehicle on, select 'Driver Assistance → Driving Assist → Highway Auto Speed Change' from the Settings menu to turn on Navigation-based Smart Cruise Control and deselect to turn off the function.

i Information

When there is a problem with Navigation-based Smart Cruise Control, the function cannot be set from the Settings menu.

Navigation-based Smart Cruise Control Operation

Operating conditions

Navigation-based Smart Cruise Control is ready to operate if all of the following conditions are satisfied:

- Smart Cruise Control is operating
- Driving on main roads of highways

i Information

For more details on how to operate Smart Cruise Control, refer to “Smart Cruise Control (SCC)” section in this chapter.

Display and control

When Navigation-based Smart Cruise Control operates, it will be displayed on the cluster as follows:

Navigation-based Smart Cruise Control standby



ONE1071028N

If the operating conditions are satisfied, the white **NAV** symbol will illuminate.

Navigation-based Smart Cruise Control operating



ONE1071101N

If temporary deceleration is required in the standby state and Navigation-based Smart Cruise Control is operating, the green **NAV** symbol will illuminate on the cluster.

If the Highway Set Speed Auto Change function operates, the **NAV** symbol and set speed will illuminate in green on the cluster, and an audible warning will sound.

WARNING



'Drive carefully' warning message will appear in the following circumstances:

- **Navigation-based Smart Cruise Control is not able to slow down your vehicle to a safe speed**

Information



Highway Curve Zone Auto Slowdown and Highway Set Speed Auto Change function uses the same  symbol.

Highway Curve Zone Auto Slowdown

- Depending on the curve ahead on the highway, the vehicle will decelerate, and after passing the curve, the vehicle will accelerate to Smart Cruise Control set speed.
- Vehicle deceleration time may differ depending on the vehicle speed and the degree of the curve on the road. The higher the driving speed, deceleration will start faster.

Highway Set Speed Auto Change

- Highway Set Speed Auto Change function will operate when Smart Cruise Control set speed and the highway speed limit is matched.
- While Highway Set Speed Auto Change function is operating, when the highway, speed limit changes, Smart Cruise Control set speed automatically changes to the changed speed limit.
- If Smart Cruise Control set speed is adjusted different from the speed limit, Highway Set Speed Auto Change function will be in the standby state.
- If Highway Set Speed Auto Change function has changed to the standby state by driving on a road other than the highway main road, Highway Set Speed Auto Change function will operate again when you drive on the main road again without setting the set speed.

- If Highway Set Speed Auto Change function has changed to the standby state by depressing the brake pedal or pressing the  switch on the steering wheel, press the  switch to restart the function.
- Highway Set Speed Auto Change function does not operate on highway interchanges or junctions.

Information

- **Highway Set Speed Auto Change function only operates based on the speed limits of the highway, it does not work with the speed cameras.**
- **When Highway Set Speed Auto Change function is operating, the vehicle automatically accelerates or decelerates when the highway speed limit changes.**
- **The maximum set speed for Highway Set Speed Auto Change function is 90 mph (140 km/h).**
- **If the speed limit of a new road is not updated in the navigation, Highway Set Speed Auto Change function may not operate properly.**
- **If the speed unit is set to a unit other than the speed unit used in your country, Highway Set Speed Auto Change function may not operate properly.**

Information

The images or colors may be displayed differently depending on the specifications of the instrument panel or theme.

Limitations of Navigation-based Smart Cruise Control

Navigation-based Smart Cruise Control may not operate properly under the following circumstances:

- The navigation is not working properly
- Map information is not transmitted due to infotainment system's abnormal operation
- Speed limit and road information in the navigation is not updated
- The map information and the actual road is different because of real-time GPS data or map information error
- The navigation searches for a route while driving
- GPS signals are blocked in areas such as a tunnel
- A road that divides into two or more roads and joins again
-

- The driver goes off course the route set in the navigation
- The route to the destination is changed or canceled by resetting the navigation
- The vehicle enters a service station or rest area
- Android Auto or Car Play is operating
- The navigation cannot detect the current vehicle position (for example, elevated roads including overpass adjacent to general roads or nearby roads exist in a parallel way)
- The navigation is being updated while driving
- The navigation is being restarted while driving
- The speed limit of some sections changes according to the road situations
- Driving on a road under construction
- Driving on a road that is controlled
- There is bad weather, such as heavy rain, heavy snow, etc.
- Driving on a road that is sharply curved

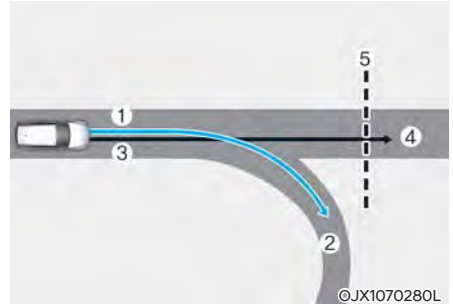

[1] : Set route, [2] : Branch line, [3] : Driving route, [4] : Main road, [5] : Curved road section

- When there is a difference between the navigation set route (branch line) and the driving route (main road), Highway Curve Zone Auto Slowdown function may not operate until the driving route is recognized as the main road.
- When the vehicle's driving route is recognized as the main road by maintaining the main road instead of the navigation set route, Highway Curve Zone Auto Slowdown function will operate. Depending on the distance to the curve and the current vehicle speed, vehicle deceleration may not be sufficient or may decelerate rapidly.

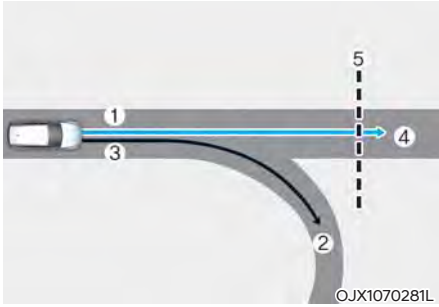

[1] : Set route, [2] : Branch line, [3] : Driving route, [4] : Main road, [5] : Curved road section

- When there is a difference between the navigation route (main road) and the driving route (branch line), Highway Curve Zone Auto Slowdown function will operate temporarily based on the curve information on the main road.
- When it is judged that you are driving out of the route by entering the highway interchange or junction, Highway Curve Zone Auto Slowdown function will not operate.
-

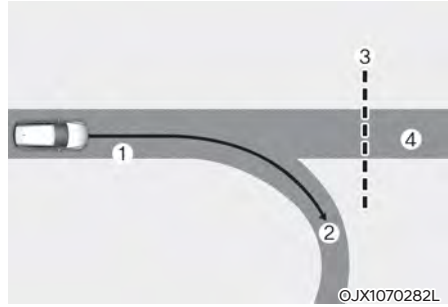

[1] : Driving route, [2] : Branch line, [3] : Curved road section, [4] : Main road

- If there is no destination set on the navigation, Highway Curve Zone Auto Slowdown function will operate based on the curve information on the main road.
- Even if you depart from the main road, Highway Curve Zone Auto Slowdown function may temporarily operate due to navigation information of the highway curve section.

**WARNING**

- Navigation-based Smart Cruise Control is not a substitute for safe driving practices, but a convenience function. Always have your eyes on the road, and it is the responsibility of the driver to avoid violating traffic laws.
- The navigation's speed limit information may differ from the actual speed limit information on the road. It is the driver's responsibility to check the speed limit on the actual driving road or lane.
- Navigation-based Smart Cruise Control will automatically be canceled when you leave the highway main road. Always pay attention to road and driving conditions while driving.
- Navigation-based Smart Cruise Control may not operate due to the existence of leading vehicles and the driving conditions of the vehicle. Always pay attention to road and driving conditions while driving.
- When you are towing a trailer or another vehicle, turn off Navigation-based Smart Cruise Control for safety reasons.
- After you pass through a tollgate on a highway, Navigation-based Smart Cruise Control will operate based on the first lane. If you enter one of the other lanes, Navigation-based Smart Cruise Control might not operate properly.
- The vehicle will accelerate if the driver depresses the accelerator pedal while Navigation-based Smart Cruise Control is operating, and the function will not decelerate the vehicle. However, if the accelerator pedal is depressed insufficiently, the vehicle may decelerate.
- If the driver accelerates and releases the accelerator pedal while Navigation-based Smart Cruise Control is operating, the vehicle may not decelerate sufficiently or may rapidly decelerate to a safe speed.
- If the curve is too large or too small, Navigation-based Smart Cruise Control may not operate.

i Information

- A time gap could occur between the navigation's guidance and when Navigation-based Smart Cruise Control operation starts and ends.
- The speed information on the cluster and navigation may differ.
- Even if you are driving at a speed lower than Smart Cruise Control set speed, acceleration may be limited by the curve sections ahead.
- If Navigation-based Smart Cruise Control is operating while leaving the main road to enter an interchange, junction, rest area, etc., the function may operate for a certain period of time.
- Deceleration by Navigation-based Smart Cruise Control may feel it is not sufficient due to road conditions such as uneven road surfaces, narrow lanes, etc.

i Information

This device complies with Part 15 of the FCC rules.

Operation is subject to the following three conditions:

1. This device may not cause harmful interference, and
2. This device must accept any interference received, including interference that may cause undesired operation of the device.
3. Changes or modifications not expressly approved by the party responsible for compliance could void the user's authority to operate the device.

i Information

Radio frequency radiation exposure information:

This equipment complies with FCC radiation exposure limits set forth for an uncontrolled environment.

This equipment should be installed and operated with minimum distance of 8 in. (20 cm) between the radiator (antenna) and your body.

This transmitter must not be co-located or operating in conjunction with any other antenna or transmitter.

LANE FOLLOWING ASSIST (LFA)

Lane Following Assist is designed to help detect lane markings and/or vehicles on the road, and assists the driver's steering to help center the vehicle in the lane.

Detecting sensor



[1]: Front view camera

The front view camera is used as a detecting sensor to detect lane markings and front vehicles.

Refer to the picture above for the detailed location of the detecting sensor.



CAUTION

For more details on the precautions of the front view camera, refer to “Forward Collision-Avoidance Assist (FCA)” section in this chapter.

Lane Following Assist Settings Setting features



Turning Lane Following Assist On/Off

With the vehicle on, shortly press the Lane Driving Assist button located on the steering wheel to turn on Lane Following Assist. The grey or green indicator light will illuminate on the cluster.

Press the button again to turn off the function.



Warning Volume

With the vehicle on, select 'Driver Assistance → Warning Volume' from the Settings menu to change the Warning Volume to 'High', 'Medium' or 'Low' for Hands-off warning.

If you change the warning volume, the Warning Volume of other Driver Assistance systems may change.

Lane Following Assist Operation

Warning and control



Lane Following Assist

If the vehicle ahead and/or both lane markings are detected and your vehicle speed is below 110 mph (180 km/h), the green  indicator light illuminates on the cluster, and Lane Following Assist helps center the vehicle in the lane by assisting the steering wheel.



CAUTION

When the steering wheel is not assisted, the white  indicator light blinks and changes to grey.



ONE1071193N

Hands-off warning

If the driver takes their hands off the steering wheel for several seconds, the 'Place hands on the steering wheel' warning message will appear and an audible warning will sound in stages.

First stage : Warning message

Second stage : Warning message (red steering wheel) and audible warning



OTM070117N

If the driver still does not have their hands on the steering wheel after the hands-off warning, the 'Lane Following Assist (LFA) canceled' warning message will appear and Lane Following Assist will be automatically canceled.

WARNING

- The steering wheel may not be assisted if the steering wheel is held very tight or the steering wheel is steered over a certain degree.
- Lane Following Assist does not operate at all times. It is the responsibility of the driver to safely steer the vehicle and to maintain the vehicle in its lane.
- The hands-off warning message may appear late depending on road conditions. Always have your hands on the steering wheel while driving.
- If the steering wheel is held very lightly the hands-off warning message may appear because Lane Following Assist may not recognize that the driver has their hands on the steering wheel.
- If you attach objects to the steering wheel, the hands-off warning may not work properly.

i Information

- For more details on setting the functions in the infotainment system, refer to “Vehicle Settings” section in chapter 4.
- When both lane markings are detected, the lane lines on the cluster will change from grey to white.

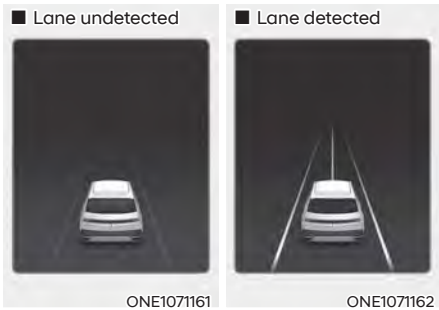

- The images and colors in the cluster may differ depending on the cluster type or theme selected from the cluster.
- If lane markings are not detected, steering wheel control by Lane Following Assist can be limited depending on whether a vehicle is in front or the driving conditions of the vehicle.
- Even though the steering is assisted by Lane Following Assist, the driver may control the steering wheel.
- The steering wheel may feel heavier or lighter when the steering wheel is assisted by Lane Following Assist than when it is not.

i Information

The images or colors may be displayed differently depending on the specifications of the instrument panel or theme.

Lane Following Assist Malfunction and Limitations

Lane Following Assist malfunction



When Lane Following Assist is not working properly, the ‘Check Lane Following Assist (LFA) system’ warning message will appear for several seconds, and the master (⚠) warning light illuminates on the cluster. If it occurs, have the vehicle be inspected by an authorized HYUNDAI dealer.

Limitations of Lane Following Assist

For more details on Lane Following Assist limitations, refer to “Lane Keeping Assist (LKA)” section in this chapter.

i Information

For more details on Lane Following Assist precautions, refer to “Lane Keeping Assist (LKA)” section in this chapter.

HIGHWAY DRIVING ASSIST (HDA) (IF EQUIPPED)

Basic function

Highway Driving Assist is designed to help detect vehicles and lanes ahead, and help maintain distance from the vehicle ahead, maintain the set speed, and help center the vehicle in the lane while driving on the highway.

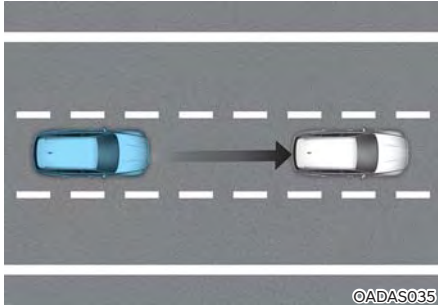

Highway Lane Change Assist (if equipped)

Highway Lane Change Assist function helps change lanes to the direction the driver slightly moves the turn signal switch if the function judges that lane change is possible.

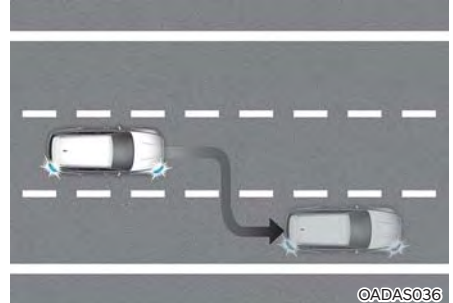

i Information

- Highway Driving Assist is available only on controlled access road of certain highways. (except for the interchange/junction)
 - * Controlled access road indicates roads with limited entrances and exits that allow uninterrupted high speed traffic flow. Only passenger cars and motorcycles are allowed on controlled access roads.
- Additional highways may be expanded by future navigation updates.

i Information

Highway Driving Assist operates on main roads of highways, and does not operate on interchange or junctions.

Detecting sensor



©ONE1071002K



©ONE1071003



©ONE1071004N

- [1] : Front view camera, [2]: Front radar,
- [3] : Front corner radar (if equipped),
- [4] : Rear corner radar (if equipped)

Refer to the picture above for the detailed location of the detecting sensors.

CAUTION

For more details on the precautions of the detecting sensors, refer to “Forward Collision-Avoidance Assist (FCA)” section in this chapter.

Highway Driving Assist Settings

Setting features

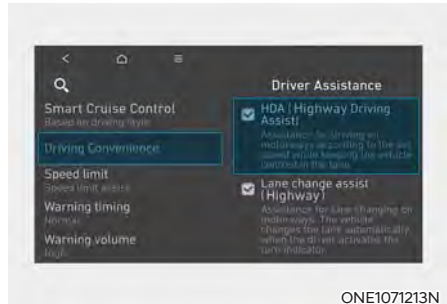

ONE1071213N

Basic function

With the vehicle on, select or deselect 'Driver Assistance → Driving Convenience' from the Settings menu to set whether to use each function.

- If 'Highway Driving Assist' is selected, it helps maintain distance from the vehicle ahead, maintain the set speed, and helps center the vehicle in the lane.

Highway Lane Change Assist (if equipped)

- If 'Highway Lane Change Assist' is selected, it helps the driver change lanes.

i Information

- When 'Highway Driving Assist' is deselected, the setting for 'Highway Lane Change Assist' cannot be changed.
- If there is a problem with the functions, the settings cannot be changed. Have the vehicle be inspected by an authorized HYUNDAI dealer.
- If the vehicle is restarted, the functions will maintain the last setting.

! WARNING

For your safety, change the Settings after parking the vehicle at a safe location.

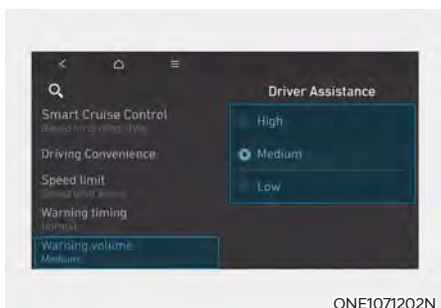

Warning Volume

With the vehicle on, select 'Driver Assistance → Warning Volume' from the Settings menu to change the Warning Volume to 'High', 'Medium' or 'Low' for Highway Driving Assist.

If you change the warning volume, the Warning Volume of other Driver Assistance systems may change.

Highway Driving Assist Operation

Basic function

Display and control

You can see the status of the Highway Driving Assist operation in the Driving Assist view on the cluster. Refer to "View Modes" section in chapter 4.

Highway Driving Assist will be displayed as below depending on the status of the function.

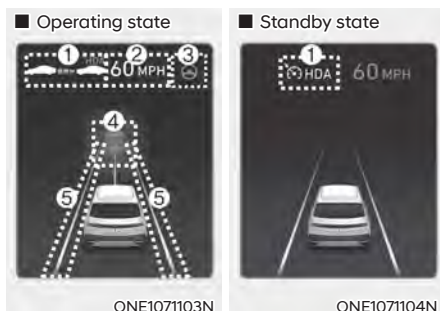

- (1) Highway Driving Assist indicator, whether there is a vehicle ahead and the selected distance level are displayed.
 - * Highway Driving Assist indicator
 - Green HDA : Operating state
 - Grey HDA : Standby state
 - White HDA blink: Accelerator depressed state
- (2) Set speed
- (3) Lane Following Assist indicator
- (4) Whether there is a vehicle ahead and the selected headway
- (5) Whether the lane is detected or not

i Information

For more details on the display refer to “Smart Cruise Control (SCC)” and “Lane Following Assist (LFA)” sections in this chapter.

Highway Driving Assist operating

Highway Driving Assist operates when:

- Driving on the main road of highways, and turning on Highway Driving Assist by pressing the Driving Assist (🛣️) button.
- Entering the main road of highways while Lane Following assist and Smart Cruise Control are operating

i Information

- **While driving on the highway, if Smart Cruise Control starts operating, Highway Driving Assist will operate.**
- **When entering the main roads of highways while Smart Cruise Control is operating, Driving Assist will not turn on if Lane Following Assist is turned off.**

- Restarting after stopping



When Highway Driving Assist is operating, your vehicle will stop if the vehicle ahead of you stops. Also, if the vehicle ahead of you starts moving within 30 seconds after the stop, your vehicle will start as well. In addition, after the vehicle has stopped and 30 seconds have passed, the ‘Use switch or pedal to accelerate’ message will appear on the cluster. Depress the accelerator pedal or push the + switch, - switch or ||○ switch to start driving.

- Hands-off warning



If the driver takes their hands off the steering wheel for several seconds, the 'Place hands on the steering wheel' warning message will appear and an audible warning will sound in stages.

First stage : Warning message

Second stage : Warning message (red steering wheel) and audible warning



If the driver still does not have their hands on the steering wheel after the hands-off warning, the 'Highway Driving Assist (HDA) canceled' warning message will appear and Highway Driving Assist and Lane Change Assist will be automatically canceled.

- Driving speed limit



When Highway Driving Assist is canceled by the hands-off warning, The driving speed will be limited.

While Driving Speed Limit function is operating, the 'Driver's grasp not detected. Driving speed will be limited' warning message will appear on the cluster, and an audible warning will sound continuously.

- Driving to one side within lane (if equipped)

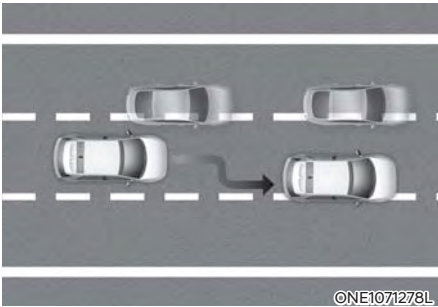

When vehicle speed is above 40 mph (60 km/h), if a vehicle around you is driving at a close distance, your vehicle will control steering in the opposite direction of the vehicle to assist in safe driving.

If there are vehicles in both sides of the lane that are driving close to you, the function will not veer to the opposite side of the lane.

Highway Driving Assist standby

When the Smart Cruise Control is temporarily canceled while Highway Driving Assist is operating, Highway Driving Assist will be in the standby state. At this time, Lane Following Assist will operate properly.

i Information

- **Driving Speed Limit helps you drive below 40 mph (60 km/h). At this time, the vehicle decelerates due to the vehicle ahead. After the vehicle has decelerated, it cannot automatically accelerate.**
- **Driving Speed Limit will cancel in the following circumstances:**
 - **When the driver grabs the steering wheel again**
 - **When the driver turns on Lane Following Assist by pressing the Lane Driving Assist button**
 - **When Smart Cruise Control switch +, -, ||○ or  button is pushed, or the accelerator pedal or the brake pedal is depressed**

Highway Lane Change Assist (if equipped)

Display and control

You can see the status of the Highway Lane Change Assist function operation in the Driving Assist view on the cluster. Refer to “View Modes” section in chapter 4.

Highway Lane Change Assist function will be displayed as below depending on the status of the function.

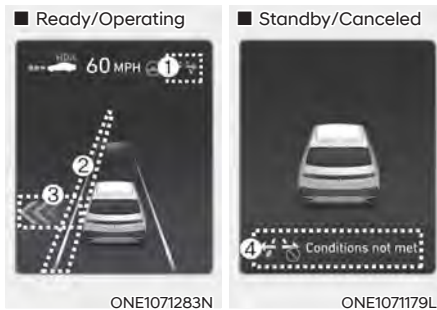

(1) Highway Lane Change Assist indicator

- Green on : Ready state
- Green blink : Operating state
- Grey on : Standby state
- White blink : Canceled state

(2) Lane line

The lane line is displayed in the same way as the Highway Lane Change Assist indicator (1) above. However, if the function is in the standby state, it displays whether the lane line is recognized or not.

(3) Green arrow and shade

The green arrow is displayed when a certain amount of time has passed after the function has started operating, and until the lane change has completed.

(4) Message

- Message is displayed when the function does not operate even though the turn signal lever is used.
- Message is displayed when the function is canceled while operating.

To turn on Highway Lane Change Assist

Highway Lane Change Assist function will turn on when the following conditions are satisfied.

- The Driving Assist button or Lane Driving Assist button is used to turn on Highway Driving Assist.

Highway Lane Change Assist ready to operate

While Highway Lane Change Assist function is on, the function will be ready to operate when all the following conditions are satisfied:

- Highway Driving Assist is operating
- Lane Following Assist is operating
- A vehicle in the rear area of your vehicle is detected more than once after the vehicle is turned on
- Your vehicle speed is above 40 mph (60 km/h)
- Hands-off warning is not displayed on the cluster
- Hazard warning flasher is off

i Information

- While Lane Change Assist function is turned on (indicator on), Lane Following Assist will not cancel even if the turn signal indicator or hazard warning flasher is operating.
- Lane Change Assist function turns off automatically when driven in the following road conditions:
 - One driving lane
 - A road with no structure, such as a medium strip, guardrails, etc.
 - There is a pedestrian or cyclist on the road ahead
- When the function is in the ready state, and vehicle speed is below 35 mph (55 km/h), the function will change to the standby state.

⚠ WARNING

When Highway Lane Change Assist function turns off while operating, steering assist will be temporarily canceled. Always be cautious while driving.

Highway Lane Change Assist operating

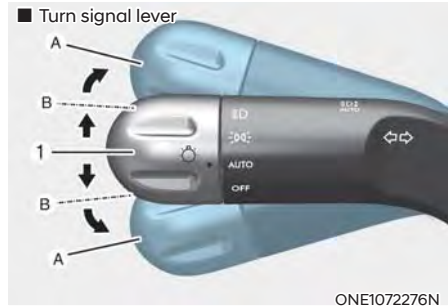

[1] : Center

Highway Lane Change Assist function will operate, when you push the turn signal lever up or down to the A or B position while the function is in the ready state (⚡ indicator is green), and all of the following conditions are satisfied:

- The driver has his/her hand on the steering wheel
- There is no collision risk in the direction of lane change
- There is a single dotted lane line in the direction of lane change
- There are no Forward Collision-Avoidance Assist and Blind Spot Collision-Avoidance Assist warnings
- The vehicle is driven in the middle of the lane (should not be driving close to one side of the lane)
- The road you are driving on, or the road you are about to change lane is a road that the function can operate

i Information

- When the turn signal lever is placed at A
When the turn signal lever is placed at A position, the Highway Lane Change Assist function is performed. After that, if the turn signal lever is placed in neutral, Highway Lane Change Assist function is canceled before stepping on the lane.

The Highway Lane Change Assist function is not canceled after stepping on the lane, but when the lane change is completed, it is canceled and the turn signal turns off.

- When the turn signal lever is placed at B position for a certain period of time, the green arrow will appear. At this time, even when the lever is released and returns to its original position (1), lane change will still be assisted.

While lane change is being made by the function, the turn signal indicator will blink even when the turn signal lever is not held, and the turn signal indicator will turn off when lane change is complete.

Highway Lane Change Assist standby

Highway Lane Change Assist function will be in the standby state when one of the ready state condition is not satisfied, or when entering or driving on one of the following roads:

- Road within a certain distance from the tollgate on the main road of the highway
- The road ahead ends without an interchange or junction
- Road with sharp curves
- Road with narrow lanes

Highway Lane Change Assist cancel

The function will be canceled when:

- When the turn signal lever is moved to A and placed in neutral before stepping on the lane while the Highway Lane Change Assist function is operating
- The turn signal lever is turned on in the opposite direction of lane change
- The steering wheel is steered sharply



WARNING

- While Highway Driving Assist is operating, the function will cancel if one of the following occurs:
 - Highway Driving Assist is turned off
 - Lane Following Assist or Smart Cruise Control is turned off or temporarily canceled
 - Hands-off warning message is displayed on the cluster
 - The hazard warning flasher is turned on
 - Forward Collision-Avoidance Assist or Blind-Spot Collision-Avoidance Assist warning message is displayed
 - Possible collision is detected in the next lane, even though there are no Forward Collision-Avoidance Assist and Blind Spot Collision-Avoidance Assist warning
 - The target lane to make a lane change disappears
 - The target lane to make a lane change is not detected
 - There is a problem with turn signal lamps
- Highway Lane Change Assist function is off (The function turns off when the function is turned off from the settings menu, when the road changes to a one-way road, when there is an intersection or crosswalk ahead, when you enter a road with no structure, such as a medium strip, guardrail, etc., or when there is a pedestrian or cyclist on the driving lane.)
- Your vehicle speed is below 35 mph (55 km/h)
- While the function is operating, when the function is canceled, depending on the driving conditions, the vehicle may drive to the middle of the driving lane or steering assist may stop. Always pay attention to road and driving conditions while driving.
- The function may not operate properly on roads with pedestrians or cyclists, such as an intersection or crosswalk. Always pay attention to road and driving conditions while driving.



Information

The images or colors may be displayed differently depending on the specifications of the instrument panel or theme.

Highway Driving Assist Malfunction and Limitation

Highway Driving Assist malfunction



When Highway Driving Assist or Highway Lane Change function is not working properly, the 'Check Highway Driving Assist (HDA) system' or 'Check Lane Change Assist function' warning message will appear, and the  warning light will illuminate on the cluster. Have the vehicle be inspected by an authorized HYUNDAI dealer.



WARNING

- The driver is responsible for controlling the vehicle for safe driving.
- Always have your hands on the steering wheel while driving.
- Highway Driving Assist is a supplemental function that assists the driver in driving the vehicle and is not a complete autonomous driving system. Always check road conditions, and if necessary, take appropriate actions to drive safely.
- Always have your eyes on the road, and it is the responsibility of the driver to avoid violating traffic laws. The vehicle manufacturer is not responsible for any traffic violation or accidents caused by the driver.
- Highway Driving Assist may not be able to recognize all traffic situations. Highway Driving Assist may not detect possible collisions due to limitations of the function. Always be aware of the limitations of the function. Obstacles (vehicles, motorcycles, bicycles, pedestrians, unspecified objects, structures, etc.) that may collide with a vehicle may not be detected.
- Highway Driving Assist will turn off automatically under the following situations:
 - Driving on roads that Highway Driving Assist does not operate, such as a rest area, intersection, junction, etc.
 - The navigation does not operate properly such as when the navigation is being updated or restarted
- Highway Driving Assist may inadvertently operate or turn off depending on road conditions (navigation information) and surroundings.
- Lane Following Assist function may be temporarily disabled when the front view camera cannot detect lanes properly or the hands-off warning is on.
- You may not hear the warning sound of Highway Driving Assist if the surrounding is noisy.

- **If the vehicle is driven at high speed above a certain speed at a curve, your vehicle may drive to one side or may depart from the driving lane.**
- **When you are towing a trailer or another vehicle, turn off Highway Driving Assist for safety reasons.**
- **The hands-off warning message may appear early or late depending on how the steering wheel is held or road conditions. Always have your hands on the steering wheel while driving.**
- **For your safety, please read the owner's manual before using the Highway Driving Assist.**
- **Highway Driving Assist will not operate when the vehicle is started, or when the detecting sensors or navigation is being initialized.**
- GPS signals are blocked in areas such as a tunnel
- The driver goes off course or the route to the destination is changed or canceled by resetting the navigation
- The vehicle enters a service station or rest area
- Android Auto or Car Play is operating
- The navigation cannot detect the current vehicle position (for example, elevated roads including overpass adjacent to general roads or nearby roads exist in a parallel way)
- White single dotted lane line or road edge cannot be detected
- The road is temporarily controlled due to construction, etc.
- There is no structure, such as a medium strip, guardrails, etc., on the road
- There is a changeable lane in the direction of lane change

Limitations of Highway Driving Assist

Highway Driving Assist and Highway Lane Change Assist (if equipped) may not operate normally, or may not operate under the following circumstances:

- The map information and the actual road is different because the navigation is not updated
- The map information and the actual road is different because of real-time GPS data or map information error
- The infotainment system is overloaded by simultaneously performing functions such as route search, video playback, voice recognition, etc.

***i* Information**

For more details on the limitations of the front view camera, front radar, front corner radar and rear corner radar, refer to “Forward Collision-Avoidance Assist (FCA)” section in this chapter.

REAR VIEW MONITOR (RVM) (IF EQUIPPED)

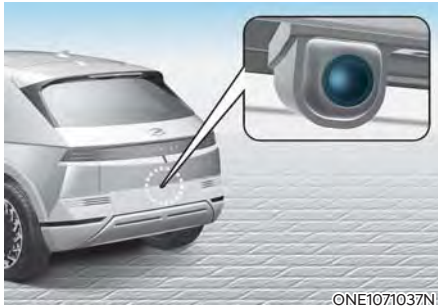

ONE1071037N

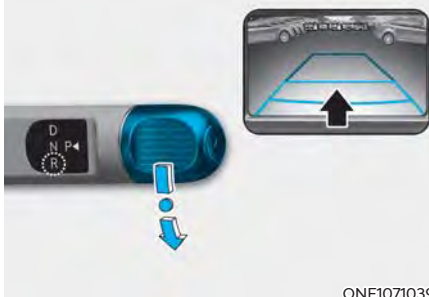

ONE1071039

Rear View Monitor shows the area behind the vehicle to assist you when parking or backing up.

Detecting sensor

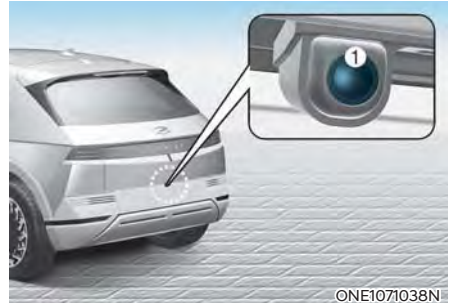

ONE1071038N

[1] : Rear view camera

Refer to the picture above for the detailed location of the detecting sensor.

Rear View Monitor Settings

Camera settings

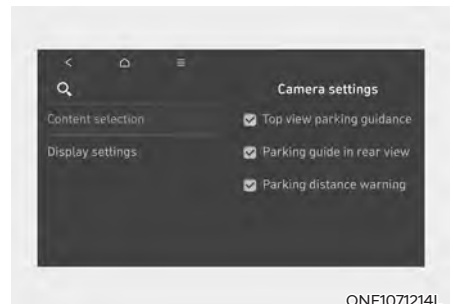

ONE1071214L

- You can change Rear View Monitor 'Display Contents' by touching the setup icon (⚙️) on the screen while Rear View Monitor is operating, or selecting 'Driver Assistance → Parking Safety → Camera Settings' from the Settings menu while the vehicle is on.
- To use Rear View while Driving, select 'Camera Settings → Display Contents → Keeps Rear Camera' from the Settings menu while the vehicle is on.
- In the Display Contents, you can change setting for 'Rear View' and in the Display Settings, you can change the screen's 'Brightness' and 'Contrast'.

Rear View Monitor Operation

Operating button

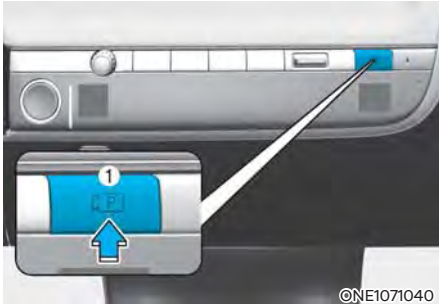

Parking/View button

Press the Parking/View button (1) to turn on Rear View Monitor.

Press the button again to turn off the function.

Rear view

Operating conditions

- Shift the gear to R (Reverse), the image will appear on the screen.
- Press the Parking/View button (1) while the gear is in P (Park), the image will appear on the screen.

Off conditions

- The rear view cannot be turned off when the gear is in R (Reverse).
- Press the Parking/View button (1) again while the gear is in P (Park) with the rear view on the screen, the rear view will turn off.
- Shift the gear from R (Reverse) to P (Park), the rear view will turn off.

Extended Rear View function

The rear view will maintain showing on the screen to help you when parking.

Operating conditions

Shift the gear from R (Reverse) to N (Neutral) or D (Drive), the rear view will appear on the screen.

Off conditions

- When vehicle speed is above 6 mph (10 km/h), the rear view will turn off.
- Shift the gear to P (Park), the rear view will turn off.

Rear view while driving



The driver is able to check the rear view on the screen while driving, it is to assist with backing up.

Operating conditions

Press the Parking/View button (1) while the gear is in D (Drive) or N (Neutral), the driving rear view will appear on the screen.

Off conditions

- Press the Parking/View button (1) again, the driving rear view will turn off.
- Press one of the infotainment system button (2), the driving rear view will turn off.
- Shift the gear to P (Park), the driving rear view will turn off.

When operating

If the gear is shifted to R (Reverse), while Driving rear view is displayed on the screen, the screen will change to rear view with parking guidance.

Rear top view

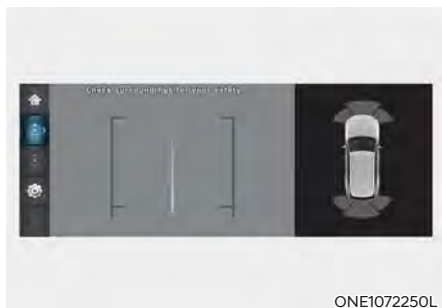

When you touch the  icon, the top view is displayed on the screen and shows the distance from the vehicle in the back of your vehicle while parking.

Rear View Monitor Malfunction and Limitations

Rear View Monitor malfunction

When Rear View Monitor is not working properly, or the screen flickers, or the camera image does not display properly, Have the vehicle be inspected by an authorized HYUNDAI dealer.



WARNING

- **The rear view camera does not cover the complete area behind the vehicle. The driver should always check the rear area directly through the inside and outside side view mirror before parking or backing up.**
- **The image shown on the screen may differ from the actual distance of the object. Make sure to directly check the vehicle's surroundings for safety.**
- **Always keep the rear view camera lens clean. If the lens is covered with foreign material, it may adversely affect camera performance and Rear View Monitor may not operate properly. However, do not use chemical solvents such as strong detergents containing high alkaline or volatile organic solvents (gasoline, acetone, etc.). This may damage the camera lens.**

SURROUND VIEW MONITOR (SVM) (IF EQUIPPED)

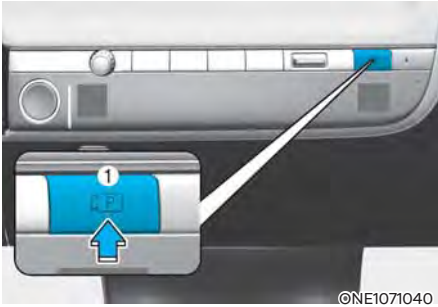

Surround View Monitor can assist in parking by allowing the driver to see around the vehicle.

Detecting sensor



- [1] : Surround-front view camera,
- [2],[3] : Surround-side view camera
(under the side view mirror),
- [4] : Surround-rear view camera

Refer to the picture above for the detailed location of the detecting sensors.

Surround View Monitor Settings

Camera settings



- You can change Surround View Monitor 'Display Contents' or 'Display Settings' by touching the setup icon (⚙️) on the screen while Surround View Monitor is operating, or selecting 'Driver Assistance → Parking Safety → Camera Settings' from the Settings menu while the vehicle is on.
- In the Display Contents, you can change settings for 'Top View Parking Guidance', 'Rear View Parking Guidance' and 'Parking Distance Warning'.

Top View Parking Guidance

■ Front top view



■ Rear top view



- When the 'Top View Parking Guidance' is selected, parking guidance is displayed on the right side of the Surround View Monitor screen.
- The 'Top View Parking Guidance' can be connected with the front top view parking guidance or the rear top view parking guidance.

Rear View Parking Guidance



- When the 'Rear View Parking Guidance' is selected, parking guidance is displayed in the rear view.
- The horizontal guideline of the Rear View Parking Guidance shows the distance of 1.6 ft. (0.5 m), 3.3 ft. (1 m) and 7.6 ft. (2.3 m) from the vehicle.

Parking Distance Warning



- When the 'Parking Distance Warning' is selected, parking distance warning is displayed on the right side of the Surround View Monitor screen.
- The image will be displayed only when Parking Distance Warning is warning the driver.

Surround View Monitor Auto On

With the vehicle on, select 'Driver Assistance → Parking Safety → Surround View Monitor Auto On' from the Settings menu to use the function.

Surround View Monitor Operation

Operating button

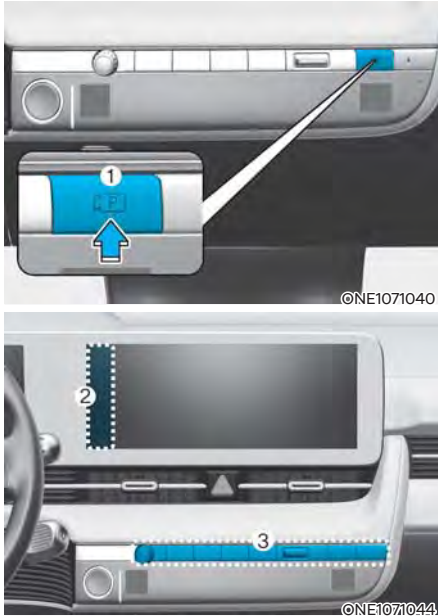

- Press the Parking/View button (1) to turn on Surround View Monitor. Press the button again to turn off the function.
- Other view modes can be selected by touching the view icons (2) on the Surround View Monitor screen.
- When one of the infotainment system button (3) is pressed without the gear in R (Reverse), Surround View Monitor will turn off.

Front view

The front image is displayed on the screen when the gear is in N (Neutral) or D (Drive) to assist in parking. The front view has a top view/front view/side view/3D view.

Operating conditions

- When the gear is shifted from R (Reverse) to N (Neutral) or D (Drive), the last set mode of front view function will be selected.
- Front view function will operate when the following conditions are satisfied:
 - While the infotainment system screen is being displayed, press the Parking/View button (1) briefly when the gear is in D (Drive) or N (Neutral) and vehicle speed is below 6 mph (10 km/h).
- Surround View Monitor Auto On function will operate when the following conditions are satisfied:
 - With 'Driver Assistance → Parking Safety → Surround View Monitor Auto On' selected from the Settings menu, the front parking assist view screen is displayed when Parking Distance Warning warns the driver while driving in D (Drive).

Off conditions

- Press the Parking/View button (1) again, the image will turn off.
- When vehicle speed is above 6 mph (10 km/h) with the gear in D (Drive), Surround View Monitor will turn off and the screen will change back to the previous infotainment system screen. Although you drive below 6 mph (10 km/h) again, Surround View Monitor will not turn on.
- Press one of the infotainment system button (3), the screen will change to the infotainment system screen.
- Shift the gear to P (Park), the image will turn off.

Rear view

The rear image is displayed on the screen when the gear is in P (Park) to assist in parking. The rear view has a top view/rear view/side view/3D view.

Operating conditions

- Shift the gear to R (Reverse), the image will appear on the screen.
- Press the Parking/View button (1) while the gear is in P (Park), the image will appear on the screen.

Off conditions

- The image cannot be turned off when the gear is in R (Reverse).
- Shift the gear from R (Reverse) to P (Park), the image will turn off.
- Press the Parking/View button (1) again while the gear is in P (Park) with the image on the screen.

Surround View Monitor Malfunction and Limitations

Surround View Monitor malfunction

When Surround View Monitor is not working properly, or the screen flickers, or the camera image does not display properly, have the vehicle be inspected by an authorized HYUNDAI dealer.

Limitations of Surround View Monitor

- The screen may be displayed abnormally, and an icon will appear at the top left side of the screen under the following circumstances:
 - The liftgate is opened
 - The driver or front passenger door is opened
 - The side view mirror is folded



WARNING

- **ALWAYS** look around your vehicle to make sure there are no objects or obstacles before moving the vehicle. What you see on the screen may differ from the actual vehicle's location.
- The image shown on the screen may differ from the actual distance of the object. Make sure to directly check the vehicle's surroundings for safety.
- Surround View Monitor is designed to be used on a flat surface. Therefore, if used on roads with different heights such as curbs and speed bumps, the image in the screen may not look correct.
- Always keep the camera lens clean. If the lens is covered with foreign material, it may adversely affect camera performance and Surround View Monitor may not operate properly. However, do not use chemical solvents such as strong detergents containing high alkaline or volatile organic solvents (gasoline, acetone, etc.). This may damage the camera lens.



Information

- When Rear View while Driving is on, it stays on while driving regardless of vehicle speed.
- When Rear View while Driving is on while backing up, the screen changes to the rear view.

REAR CROSS-TRAFFIC COLLISION-AVOIDANCE ASSIST (RCCA) (IF EQUIPPED)

Rear Cross-Traffic Collision-Avoidance Assist is designed to help detect vehicles approaching from the rear left and right side while your vehicle is reversing, and warn the driver that a collision is imminent with a warning message and an audible warning. Also, braking is assisted to help prevent collision.

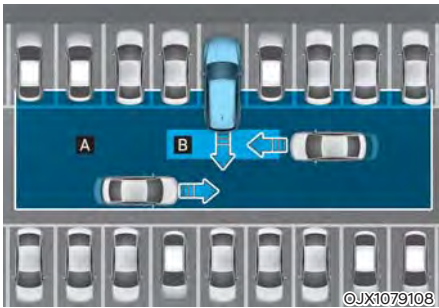

- [A] : Rear Cross-Traffic Collision Warning operating range,
- [B] : Rear Cross-Traffic Collision-Avoidance Assist operating range

CAUTION

Warning timing may vary depending on vehicle speed of the approaching vehicle.

Detecting sensor



[1] : Rear corner radar

Refer to the picture above for the detailed location of the detecting sensors.

Information

For more details on the precautions of the rear corner radar, refer to “Blind-Spot Collision-Avoidance Assist (BCA)” section in this chapter.

Rear Cross-Traffic Collision-Avoidance Assist Settings

Setting features

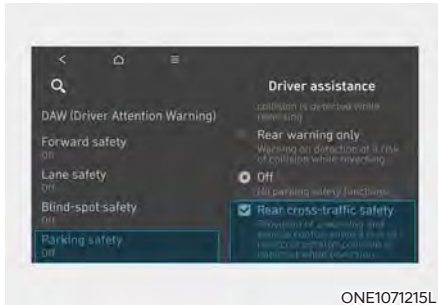

ONE1071215L

Rear Cross-Traffic Safety

With the vehicle on, select 'Driver Assistance → Parking Safety → Rear Cross-Traffic Safety' from the Settings menu to turn on Rear Cross-Traffic Collision-Avoidance Assist and deselect to turn off the function.



WARNING

When the vehicle is restarted, Rear Cross-Traffic Collision-Avoidance Assist will always turn on. However, if 'Off' is selected after the vehicle is restarted, the driver should always be aware of the surroundings and drive safely.

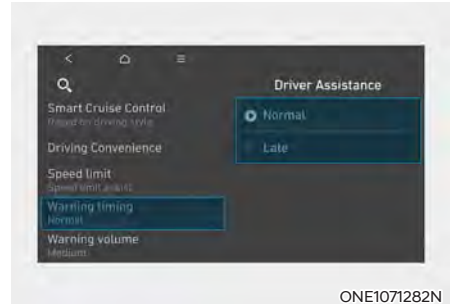

ONE1071282N

Warning Timing

With the vehicle on, select 'Driver Assistance → Warning Timing' from the Settings menu to change the initial warning activation time for Rear Cross-Traffic Collision-Avoidance Assist.

When the vehicle is first delivered, Warning Timing is set to 'Normal'. If you change the Warning Timing, the Warning Timing of other Driver Assistance systems may change.



Warning Volume

With the vehicle on, select 'Driver Assistance → Warning Volume' from the Settings menu to change the Warning Volume to 'High', 'Medium' or 'Low' for Rear Cross-Traffic Collision-Avoidance Assist.

If you change the warning volume, the Warning Volume of other Driver Assistance systems may change.

CAUTION

- The setting of the Warning Timing and Warning Volume applies to all functions of the Rear Collision-Avoidance Assist.
- Even though 'Normal' is selected for Warning Timing, if a vehicle from the left or right side approaches at high speed, warning may seem late.
- Select 'Late' for Warning Timing when traffic is light and when driving speed is slow.

Information

If the vehicle is restarted, Warning Timing and Warning Volume will maintain the last setting.

Rear Cross-Traffic Collision-Avoidance Assist Operation

Warning and control

Rear Cross-Traffic Collision-Avoidance Assist will warn and control the vehicle depending on collision risk level: 'Collision Warning', 'Emergency Braking' and 'Stopping vehicle and ending brake control'.



Collision Warning

- To warn the driver of an approaching vehicle from the rear left/right side of your vehicle, the warning light on the side view mirror will blink and a warning will appear on the cluster. At the same time, an audible warning will sound. If the Rear View Monitor is operating, a warning will also appear on the infotainment system screen.

- Rear Cross-Traffic Collision-Avoidance Assist will operate when all the following conditions are satisfied:
 - The gear is shifted to R (Reverse)
 - Vehicle speed is below 5 mph (8 km/h)
 - The approaching vehicle is within approximately 82 ft. (25 m) from the left and right side of your vehicle
 - The speed of the vehicle approaching from the left and right is above 3 mph (5 km/h)

i Information

If the operating conditions are satisfied, there will be a warning whenever the vehicle approaches from the left or right side even though your vehicle speed is 0 mph (0 km/h).



ONE1071248K

ONE1071046L

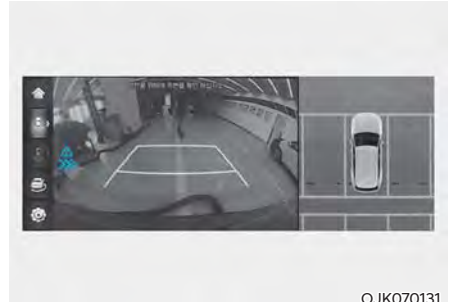

OJK070131

Emergency Braking

- To warn the driver of an approaching vehicle from the rear left/right side of your vehicle, the warning light on the side view mirror will blink and a warning message will appear on the cluster. At the same time, an audible warning will sound. A warning will also appear on the infotainment system screen.

- Rear Cross-Traffic Collision-Avoidance Assist will operate when all the following conditions are satisfied:
 - The gear is shifted to R (Reverse)
 - Vehicle speed is below 5 mph (8 km/h)
 - The approaching vehicle is within approximately 5 ft. (1.5 m) from the left and right side of your vehicle
 - The speed of the vehicle approaching from the left and right is above 3 mph (5 km/h)
- Emergency braking will be assisted to help prevent collision with approaching vehicles from the left and right.



WARNING

Brake control will end when:

- **The approaching vehicle is out of the detecting range**
- **The approaching vehicle passes behind your vehicle**
- **The approaching vehicle does not drive toward your vehicle**
- **The approaching vehicle speed slows down**
- **The driver depresses the brake pedal with sufficient power**



Stopping vehicle and ending brake control

- When the vehicle is stopped due to emergency braking, the 'Drive carefully' warning message will appear on the cluster.
- For your safety, the driver should depress the brake pedal immediately and check the surroundings.
- Brake control will end after the vehicle is stopped by emergency braking for approximately 2 seconds.
- During emergency braking, braking control by Rear Cross-Traffic Collision-Avoidance Assist will automatically cancel when the driver excessively depresses the brake pedal.



WARNING

Take the following precautions when using Rear Cross-Traffic Collision-Avoidance Assist:

- For your safety, change the Settings after parking the vehicle at a safe location.
- If any other system's warning message is displayed or audible warning is generated, Rear Cross-Traffic Collision-Avoidance Assist's warning message may not be displayed and audible warning may not be generated.
- You may not hear the warning sound of Rear Cross-Traffic Collision-Avoidance Assist if the surrounding is noisy.
- Rear Cross-Traffic Collision-Avoidance Assist may not operate if the driver applies the brake pedal to avoid collision.
- During Rear Cross-Traffic Collision-Avoidance Assist operation, the vehicle may stop suddenly injuring passengers and shifting loose objects. Always have the seat belt on and keep loose objects secured.
- Even if there is a problem with Rear Cross-Traffic Collision-Avoidance Assist, the vehicle's basic braking performance will operate properly.
- When Rear Cross-Traffic Collision-Avoidance Assist is operating, braking control by the function will automatically cancel when the driver excessively depresses the accelerator pedal.
- Rear Cross-Traffic Collision-Avoidance Assist does not operate in all situations or cannot avoid all collisions.
- Rear Cross-Traffic Collision-Avoidance Assist may warn the driver late or may not warn the driver depending on the road and driving conditions.

- The driver should hold the responsibility to control the vehicle. Do not solely depend on Rear Cross-Traffic Collision-Avoidance Assist. Rather, maintain a safe braking distance, and if necessary, depress the brake pedal to reduce driving speed or to stop the vehicle.
- Never deliberately operate Rear Cross-Traffic Collision-Avoidance Assist on people, animal, objects, etc. It may cause serious injury or death.



CAUTION

The brake control may not operate properly depending on the status of ESC (Electronic Stability Control).

There will only be a warning when:

- The ESC (Electronic Stability Control) warning light is on
- ESC (Electronic Stability Control) is engaged in a different function



Information

If braking is assisted by Rear Cross-Traffic Collision-Avoidance Assist, the driver must immediately depress the brake pedal and check vehicle surroundings.

- Brake control will end when the driver depresses the brake pedal with sufficient power.
- After shifting the gear to R (Reverse), braking control will operate once for left and right vehicle approach.



Information

The images or colors may be displayed differently depending on the specifications of the instrument panel or theme.

Rear Cross-Traffic Collision-Avoidance Assist Malfunction and Limitations

Rear Cross-Traffic Collision-Avoidance Assist malfunction

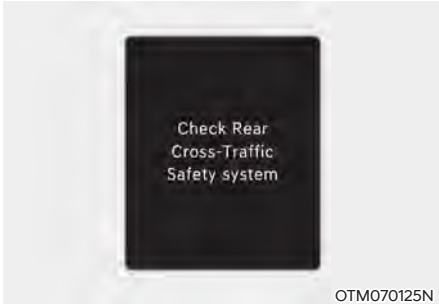

When Rear Cross-Traffic Collision-Avoidance Assist is not working properly, the 'Check Rear Cross-Traffic Safety system' warning message will appear on the cluster for several seconds, and the master (⚠) warning light will illuminate on the cluster. If it occurs, have the vehicle be inspected by an authorized HYUNDAI dealer.



When the side view mirror warning light is not working properly, the 'Check side view mirror warning light' (or 'Check outside mirror warning icon') warning message will appear on the cluster for several seconds, and the master (⚠) warning light will illuminate on the cluster. If it occurs, have the vehicle be inspected by an authorized HYUNDAI dealer.

Rear Cross-Traffic Collision-Avoidance Assist disabled

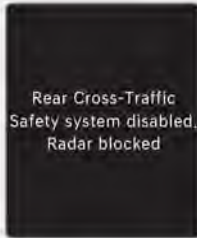

OTM070124N

When the rear bumper around the rear-side radar or sensor is covered with foreign material, such as snow or rain, or installing a trailer or carrier, it can reduce the detecting performance and temporarily limit or disable Rear Cross-Traffic Collision-Avoidance Assist.

If this occurs, the 'Rear Cross-Traffic Safety system disabled. Radar blocked' warning message will appear on the cluster.

Rear Cross-Traffic Collision-Avoidance Assist will operate properly when such foreign material or trailer, etc., is removed.

If Rear Cross-Traffic Collision-Avoidance Assist does not operate properly after it is removed, have the vehicle be inspected by an authorized HYUNDAI dealer.

WARNING

- Even though the warning message does not appear on the cluster, Rear Cross-Traffic Safety system may not operate properly.
- Rear Cross-Traffic Safety system may not operate properly in an area (for example, open terrain), where any substance are not detected after turning ON the vehicle.

CAUTION

Turn off Rear Cross-Traffic Collision-Avoidance Assist to install or remove a trailer, carrier, or another attachment. Turn on Rear Cross-Traffic Collision-Avoidance Assist when finished.

Limitations of Rear Cross-Traffic Collision-Avoidance Assist

Rear Cross-Traffic Collision-Avoidance Assist may not operate properly, or it may operate unexpectedly under the following circumstances:

- Departing from where trees or grass are overgrown
- Departing from where roads are wet
- Speed of the approaching vehicle is fast or slow

Braking control may not work, driver's attention is required in the following circumstances:

- The vehicle severely vibrates while driving over a bumpy road, uneven road or concrete patch
- Driving on a slippery surface due to snow, water puddle, ice, etc.
- The tire pressure is low or a tire is damaged
- The braking system has been modified
- Remote Smart Parking Assist is operating (if equipped)

Information

For more details on the limitations of the rear corner radar, refer to "Blind-Spot Collision-Avoidance Assist (BCA)" section in this chapter.



WARNING

- Driving near a vehicle or structure

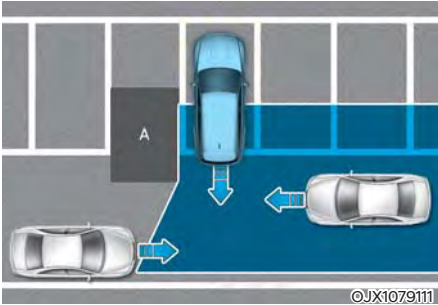

[A] : Structure

Rear Cross-Traffic Collision-Avoidance Assist may be limited when driving near a vehicle or structure, and may not detect the vehicle approaching from the left or right. If this occurs, the function may not warn the driver or control the brakes when necessary.

Always check your surroundings while backing up.

- When the vehicle is in a complex parking environment

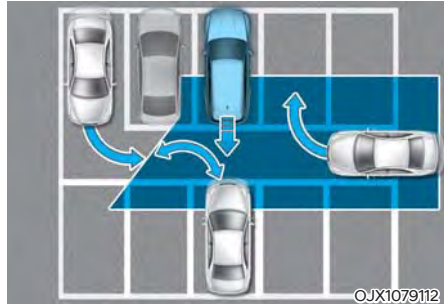

Rear Cross-Traffic Collision-Avoidance Assist may detect vehicles which are parking or pulling out near your vehicle (for example, a vehicle leaving beside your vehicle, a vehicle parking or pulling out in the rear area, a vehicle approaching your vehicle making a turn, etc.). If this occurs, the function may unnecessarily warn the driver and control the brake.

Always check your surroundings while backing up.

- When the vehicle is parked diagonally

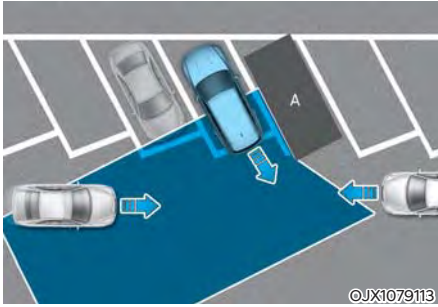

[A] : Vehicle

Rear Cross-Traffic Collision-Avoidance Assist may be limited when backing up diagonally, and may not detect the vehicle approaching from the left or right. If this occurs, the function may not warn the driver or control the brakes when necessary.

Always check your surroundings while backing up.

- When the vehicle is on or near a slope

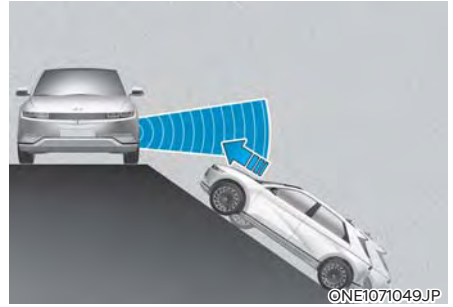

Rear Cross-Traffic Collision-Avoidance Assist may be limited when the vehicle is on a uphill or downhill slope, or near it, and may not detect the vehicle approaching from the left or right. If this occurs, the function may not warn the driver or control the brakes when necessary.

Always check your surroundings while backing up.

- Pulling into the parking space where there is a structure

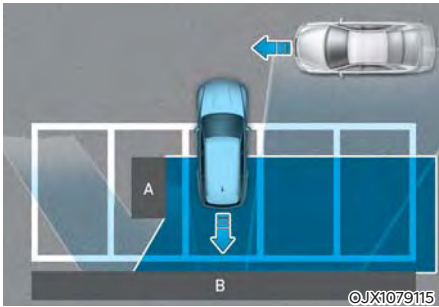

[A] : Structure, [B] : Wall

Rear Cross-Traffic Collision-Avoidance Assist may detect vehicles passing by in front of you when parking in reverse into a parking space with a wall or structure in the rear or side area. If this occurs, the function may unnecessarily warn the driver and control the brake.

Always check your surroundings while backing up.

- When the vehicle is parked rearward

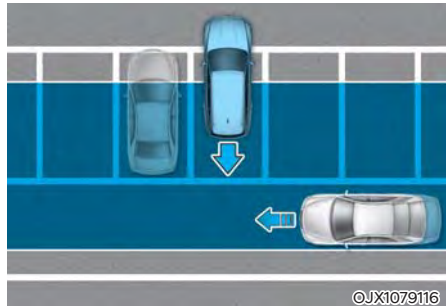

Rear Cross-Traffic Collision-Avoidance Assist may detect vehicles passing by behind you when parking in reverse into a parking space. If this occurs, the function may unnecessarily warn the driver and control the brake. Always check your surroundings while backing up.



WARNING

- When you are towing a trailer or another vehicle, turn off Rear Cross-Traffic Collision-Avoidance Assist for safety reasons.
- Rear Cross-Traffic Collision-Avoidance Assist may not operate properly if interfered by strong electromagnetic waves.
- Rear Cross-Traffic Collision-Avoidance Assist may not operate for 15 seconds after the vehicle is started, or the rear corner radars are initialized.



Information

This device complies with Part 15 of the FCC rules.

Operation is subject to the following three conditions:

1. This device may not cause harmful interference, and
2. This device must accept any interference received, including interference that may cause undesired operation of the device.
3. Changes or modifications not expressly approved by the party responsible for compliance could void the user's authority to operate the device.



Information

Radio frequency radiation exposure information:

This equipment complies with FCC radiation exposure limits set forth for an uncontrolled environment.

This equipment should be installed and operated with minimum distance of 8 in. (20 cm) between the radiator (antenna) and your body.

This transmitter must not be co-located or operating in conjunction with any other antenna or transmitter.

REVERSE PARKING DISTANCE WARNING (PDW) (IF EQUIPPED)

Reverse Parking Distance Warning can help warn the driver if an obstacle is detected within a certain distance when the vehicle is moving in reverse at low speeds.

Detecting sensor



[1] : Rear ultrasonic sensors

Refer to the picture above for the detailed location of the detecting sensors.

Reverse Parking Distance Warning Settings

Warning Volume

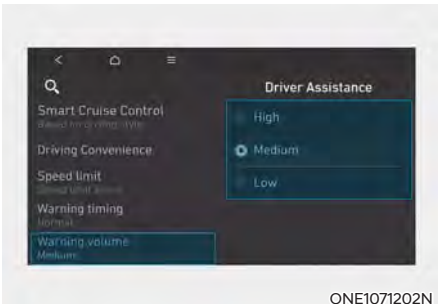

With the vehicle on, select 'Driver Assistance → Warning Volume' from the Settings menu to change the Warning Volume to 'High', 'Medium' or 'Low' for Reverse Parking Distance Warning.

If you change the warning volume, the Warning Volume of other Driver Assistance systems may change.

Reverse Parking Distance Warning Operation

Operating button

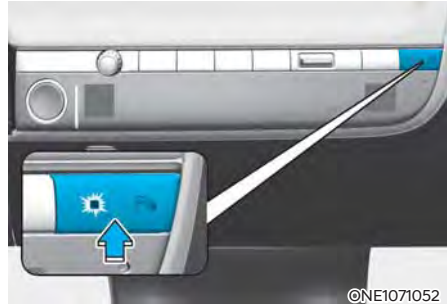



Parking Safety button (if equipped)

- Press the Parking Safety (P) button to turn on Reverse Parking Distance Warning. Press the button again to turn off the function.
- When Reverse Parking Distance Warning is off (button indicator light off), if you shift the gear to R (Reverse), Reverse Parking Distance Warning will automatically turn on.

Reverse Parking Distance Warning

- Reverse Parking Distance Warning will operate when the gear is in R (Reverse).
- Reverse Parking Distance Warning helps detect a person, animal or object in the rear when the vehicle's rearward speed is below 6 mph (10 km/h).

Distance from object	Warning indicator when driving backward	Warning sound
24 - 48 in. (60 - 120 cm)		Buzzer beeps intermittently
12 - 24 in. (30 - 60 cm)		Beeps more frequently
12 in. (within 30 cm)		Beeps continuously

- The corresponding indicator will illuminate whenever each ultrasonic sensor detects a person, animal or object in its sensing range. Also an audible warning will sound.
- When more than two objects are detected at the same time, the closest one will be warned with an audible warning.
- The shape of the indicator in the illustration may differ from the actual vehicle.

Reverse Parking Distance Warning Malfunction and Precautions

Reverse Parking Distance Warning malfunction

After starting the vehicle, a beep will sound when the gear is shifted to R (Reverse) to indicate Reverse Parking Distance Warning is operating properly.

However, if one or more of the following occurs, first check whether the ultrasonic sensor is damaged or blocked with foreign material. If it still does not work properly, have the vehicle be inspected by an authorized HYUNDAI dealer.

- The audible warning does not sound.
- The buzzer sounds intermittently.
- The 'Ultrasonic sensor error or blockage' warning message appears on the cluster.





WARNING

- **Reverse Parking Distance Warning is a supplemental function. The operation of Reverse Parking Distance Warning can be affected by several factors (including environmental conditions). It is the responsibility of the driver to always check the rear view before and while parking.**
- **Your new vehicle warranty does not cover any accidents or damage to the vehicle due to the malfunction of Reverse Parking Distance Warning.**
- **Pay close attention when driving near objects, pedestrians, and especially children. Some objects may not be detected by the ultrasonic sensors, due to the objects distance, size or material, all of which can limit the effectiveness of the sensor.**

Limitations of Reverse Parking Distance Warning

- Reverse Parking Distance Warning may not operate properly when:
 - Moisture is frozen to the sensor
 - Sensor is covered with foreign material, such as snow or water (Reverse Parking Distance Warning will operate properly when such foreign material are removed.)
 - The weather is extremely hot or cold The sensor or sensor assembly is disassembled
 - The surface of the sensor is pressed hard or hit with a hard object
 - The surface of the sensor is scratched with a sharp object
 - The sensors or its surrounding area is directly sprayed with high pressure washer
- Reverse Parking Distance Warning may malfunction when:
 - Heavy rain or water spray is present
 - Water flows on the surface of the sensor
 - Affected by another vehicle's sensors
 - The sensor is covered with snow
 - Driving on uneven road, gravel roads or bushes
 - Objects that generates ultrasonic waves are near the sensor
 - License plate is installed in a different spot from the original location
 - The vehicle bumper height or ultrasonic sensor installation has been modified
 - Attaching equipment or accessories next to the ultrasonic sensors
- The following objects may not be detected:
 - Sharp or slim objects, such as ropes, chains or small poles.
 - Objects, which tend to absorb sensor frequency, such as clothes, spongy material or snow.
 - Objects smaller than 40 in. (100 cm) in length and narrower than 6 in. (14 cm) in diameter.
 - Pedestrians, animals or objects that are very close to the ultrasonic sensors
- Parking Distance Warning Indicators may be displayed differently from the actual detected location when the obstacle is located between the sensors.
- Parking Distance Warning indicator may not occur sequentially depending on vehicle speed or obstacle shape.
- If Reverse Parking Distance Warning needs repair, have the vehicle be inspected by an authorized HYUNDAI dealer.

FORWARD/REVERSE PARKING DISTANCE WARNING (PDW) (IF EQUIPPED)

Forward/Reverse Parking Distance Warning will help warn the driver if an obstacle is detected within a certain distance when the vehicle is moving forward or in reverse at low speeds.

Detecting sensor

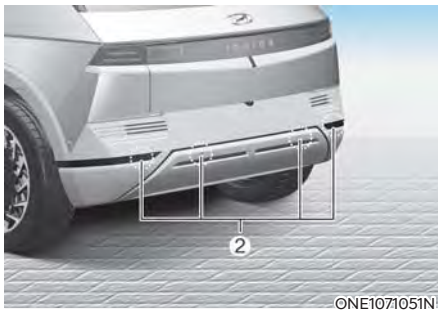
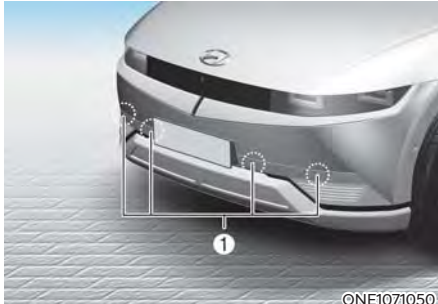

- [1] : Front ultrasonic sensors,
[2] : Rear ultrasonic sensors

Refer to the picture above for the detailed location of the detecting sensors.

Forward/Reverse Parking Distance Warning Settings

Warning Volume

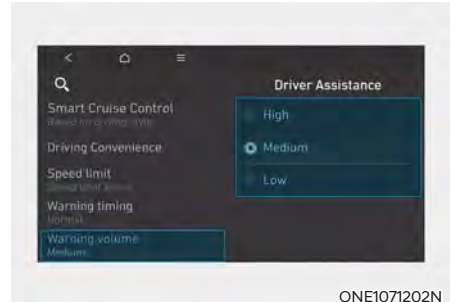

With the vehicle on, select 'Driver Assistance → Warning Volume' from the Settings menu to change the Warning Volume to 'High', 'Medium' or 'Low' for Forward/Reverse Parking Distance Warning.

If you change the Warning Volume, the warning volume of other Driver Assistance systems may change.

Parking Distance Warning Auto On

To use Parking Distance Warning Auto On function, select 'Driver Assistance → Parking Safety → Parking Distance Warning Auto On' from the cluster or infotainment system Settings menu.

Forward/Reverse Parking Distance Warning Operation

Operating button





Parking Safety button

- Press the Parking Safety (P) button to turn on Forward/Reverse Parking Distance Warning. Press the button again to turn off the function.
- When Forward/Reverse Parking Distance Warning is off (button indicator light off), if you shift the gear to R (Reverse), Forward/Reverse Parking Distance Warning will automatically turn on.
- When Forward/Reverse Parking Distance Warning turns on, the button indicator light will turn on. If vehicle speed is above 12 mph (20 km/h), Forward/Reverse Parking Distance Warning will turn off (button indicator light off).
 - * If equipped with Reverse Parking Collision-Avoidance Assist or Remote Smart Parking Assist, Forward/Reverse Parking Distance Warning will turn off (button indicator light off) when vehicle speed is above 18 mph (30 km/h).

Forward Parking Distance Warning



- Forward Parking Distance Warning will operate when one of the condition is satisfied.
 - The gear is shifted from R (Reverse) to D (Drive) with Reverse Parking Distance Warning on
 - The gear is in D (Drive) and the Parking Safety button indicator light is on
 - 'Parking Distance Warning Auto On' is selected from the Settings menu and the gear is in D (Drive)
- Forward Parking Distance Warning helps detect a person, animal or object in front when the vehicle's forward speed is below 6 mph (10 km/h).
- Forward Parking Distance Warning does not operate when the vehicle's forward speed is above 6 mph (10 km/h) even when the Parking Safety button indicator is on. Forward Parking Distance Warning will operate again when the vehicle's forward speed decreases below 6 mph (10 km/h) while the Parking Safety button indicator is on.
- When 'Parking Distance Warning Auto On' is selected, the Parking Safety button indicator light stays on.
- When 'Parking Distance Warning Auto On' is deselected, and the vehicle's forward speed is above 12 mph (20 km/h), the Parking Safety (P) button indicator will turn off. Although you drive below 6 mph (10 km/h), Forward Parking Distance Warning will not turn on.
 - * If equipped with Reverse Parking Collision-Avoidance Assist or Remote Smart Parking Assist, Forward/Reverse Parking Distance Warning will turn off when vehicle speed is above 18 mph (30 km/h).

Distance from object	Warning indicator when driving forward	Warning sound
24 - 40 in. (60 - 100 cm)		Buzzer beeps intermittently
12 - 24 in. (30 - 60 cm)		Beeps more frequently
12 in. (within 30 cm)		Beeps continuously

- The corresponding indicator will illuminate whenever each ultrasonic sensor detects a person, animal or object in its sensing range. Also an audible warning will sound.
- When more than two objects are detected at the same time, the closest one will be warned with an audible warning.
- The shape of the indicator in the illustration may differ from the actual vehicle.

Reverse Parking Distance Warning

- Reverse Parking Distance Warning will operate when the gear is in R (Reverse).
- Reverse Parking Distance Warning helps detect a person, animal or object in the rear when the vehicle's rearward speed is below 6 mph (10 km/h).
- When the vehicle's rearward speed is below 6 mph (10 km/h), both the front and rear ultrasonic sensors will help detect objects. However, the front ultrasonic sensors can help detect a person, animal or object when it is within 24 in. (60 cm) from the sensors.

Distance from object	Warning indicator when driving backward	Warning sound
24 - 48 in. (60 - 120 cm)		Buzzer beeps intermittently
12 - 24 in. (30 - 60 cm)		Beeps more frequently
12 in. (within 30 cm)		Beeps continuously

- The corresponding indicator will illuminate whenever each ultrasonic sensor detects a person, animal or object in its sensing range. Also an audible warning will sound.
- When more than two objects are detected at the same time, the closest one will be warned with an audible warning.
- The shape of the indicator in the illustration may differ from the actual vehicle.

Forward/Reverse Parking Distance Warning Malfunction and Precautions

Forward/Reverse Parking Distance Warning malfunction

After starting the vehicle, a beep will sound when the gear is shifted to R (Reverse) to indicate Forward/Reverse Parking Distance Warning is operating properly.

However, if one or more of the following occurs, first check whether the ultrasonic sensor is damaged or blocked with foreign material. If it still does not work properly, have the vehicle be inspected by an authorized HYUNDAI dealer.

- The audible warning does not sound.
- The buzzer sounds intermittently.
- The 'Ultrasonic sensor error or blockage' warning message appears on the cluster.



WARNING

- **Forward/Reverse Parking Distance Warning is a supplemental function. The operation of Forward/Reverse Parking Distance Warning can be affected by several factors (including environmental conditions). It is the responsibility of the driver to always check the front and rear views before and while parking.**
- **Your new vehicle warranty does not cover any accidents or damage to the vehicle due to the malfunction of Forward/Reverse Parking Distance Warning.**
- **Pay close attention when driving near objects, pedestrians, and especially children. Some objects may not be detected by the ultrasonic sensors, due to the objects distance, size or material, all of which can limit the effectiveness of the sensor.**

Limitations of Forward/Reverse Parking Distance Warning

- Forward/Reverse Parking Distance Warning may not operate properly when:
 - Moisture is frozen to the sensor
 - Sensor is covered with substance, such as snow or water (Forward/Reverse Parking Distance Warning will operate properly when such substance is removed.)
 - The weather is extremely hot or cold
 - The sensor or sensor assembly is disassembled
 - The surface of the sensor is pressed hard or hit with a hard object
 - The surface of the sensor is scratched with a sharp object
 - The sensors or its surrounding area is directly sprayed with high pressure washer
- Forward/Reverse Parking Distance Warning may malfunction when:
 - Heavy rain or water spray is present
 - Water flows on the surface of the sensor
 - Affected by another vehicle's sensors
 - The sensor is covered with snow or ice
 - Driving on uneven road, gravel roads or bushes
 - Objects that generates ultrasonic waves are near the sensor
- License plate is installed in a different spot from the original location
- The vehicle bumper height or ultrasonic sensor installation has been modified
- Attaching equipment or accessories next to the ultrasonic sensors
- The following objects may not be detected:
 - Sharp or slim objects, such as ropes, chains or small poles.
 - Objects, which tend to absorb sensor frequency, such as clothes, spongy material or snow.
 - Objects smaller than 40 in. (100 cm) in length and narrower than 6 in. (14 cm) in diameter.
 - Pedestrians, animals or objects that are very close to the ultrasonic sensors
- Parking Distance Warning Indicators may be displayed differently from the actual detected location when the obstacle is located between the sensors.
- Parking Distance Warning indicator may not occur sequentially depending on vehicle speed or obstacle shape.
- If Forward/Reverse Parking Distance Warning needs repair, have the vehicle be inspected by an authorized HYUNDAI dealer.

REVERSE PARKING COLLISION-AVOIDANCE ASSIST (PCA) (IF EQUIPPED)

Reverse Parking Collision-Avoidance Assist can warn the driver or assist with braking to help reduce the possibility of collision with a pedestrian or an object when backing up.

Detecting sensor

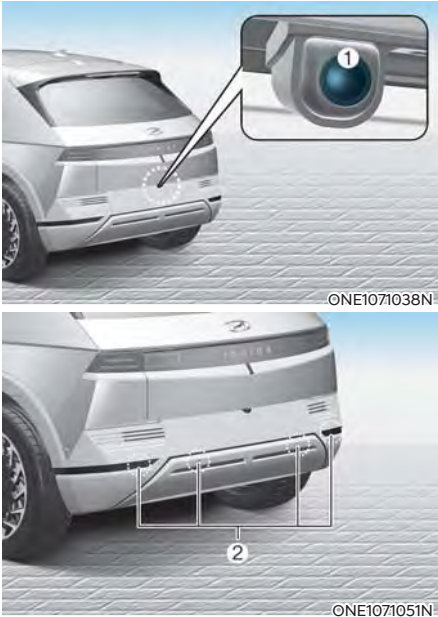

[1] : Rear view camera,
[2] : Rear ultrasonic sensors

Refer to the picture above for the detailed location of the detecting sensors.

Reverse Parking Collision-Avoidance Assist Settings

Setting features

Parking Safety

- With the vehicle on, select or deselect 'Driver Assistance → Parking Safety' from the Settings menu to set whether or not to use each function.
 - If 'Rear Active Assist' (or 'Active rear assist') is selected, Reverse Parking Collision-Avoidance Assist will warn the driver and assist with braking when a collision with a pedestrian or an object is imminent.
 - If 'Rear Warning Only' (or 'Rear warning only') is selected, Reverse Parking Collision-Avoidance Assist will warn the driver when a collision with a pedestrian or an object is imminent. Braking will not be assisted.
 - If 'Off' is selected, Reverse Parking Collision-Avoidance Assist will turn off.
- If Parking Safety (P_{SA}) button is pressed more than 2 seconds, 'Rear Active Assist' or 'Rear Warning Only' can be turned on or off.
 - Whenever the vehicle is restarted, 'Rear Active Assist' is automatically selected.

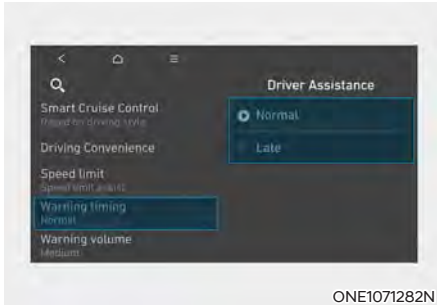

Warning Timing

With the vehicle on, select 'Driver Assistance → Warning Timing' from the Settings menu to change the initial warning activation time for Reverse Parking Collision-Avoidance Assist.

If you change the Warning Timing, the Warning Timing of other Driver Assistance systems may change.

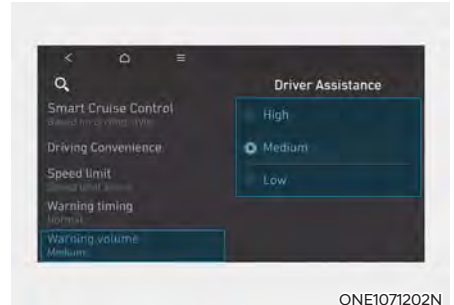

Warning Volume

With the vehicle on, select 'Driver Assistance → Warning Volume' from the Settings menu to change the Warning Volume to 'High', 'Medium' or 'Low' for Reverse Parking Collision-Avoidance Assist.

If you change the warning volume, the Warning Volume of other Driver Assistance systems may change.

Reverse Parking Collision-Avoidance Assist Operation

Operating conditions

If 'Rear Active Assist' or 'Rear Warning Only' is set from the Settings menu, Reverse Parking Collision-Avoidance Assist will be in the ready status when the following conditions are satisfied:

- The liftgate is closed
- The gear is shifted to R (Reverse)
- Vehicle speed is below 6 mph (10 km/h)
- Reverse Parking Collision-Avoidance Assist components such as the rear view camera and the rear ultrasonic sensors are in normal conditions

When Reverse Parking Collision-Avoidance Assist activates, a line appears behind the vehicle image in the instrument cluster.

Reverse Parking Collision-Avoidance Assist operates only once after the gear is shifted to R (Reverse). To reactivate Reverse Parking Collision-Avoidance Assist, shift the gear from another gear to R (Reverse).

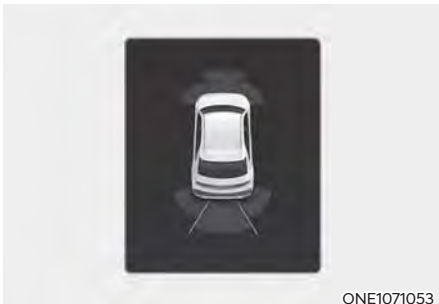

Rear Active Assist

- If Reverse Parking Collision-Avoidance Assist detects a risk of collision with a pedestrian or an object, Reverse Parking Collision-Avoidance Assist will warn the driver with an audible warning and warning message on the cluster. When Rear View Monitor is operating, a warning will appear on the infotainment system screen.
- If Reverse Parking Collision-Avoidance Assist detects an imminent collision with a pedestrian or an object behind the vehicle, Reverse Parking Collision-Avoidance Assist will assist you with braking. The driver needs to pay attention as the brake assist will end within 5 minutes. The driver must immediately depress the brake pedal and check vehicle surroundings.
- Brake control will end when:
 - The gear is shifted to P (Park) or D (Drive).
 - The driver depresses the brake pedal with sufficient power
 - Braking assist has last for approximately 5 minutes, the Electronic Parking Brake (EPB) is engaged at the brake assist is released
- The warning will turn off when:
 - The gear is shifted to P (Park), N (Neutral), or D (Drive)

Rear Warning Only

- If Reverse Parking Collision-Avoidance Assist detects a risk of collision with a pedestrian or an object, Reverse Parking Collision-Avoidance Assist will warn the driver with an audible warning and warning message on the cluster. When Rear View Monitor is operating, a warning will appear on the infotainment system screen.
- If 'Rear Warning Only' is selected, braking will not be assisted.
- The warning will turn off when the gear is shifted to P (Park), N (Neutral) or D (Drive).

Reverse Parking Collision-Avoidance Assist Malfunction and Limitations

Reverse Parking Collision-Avoidance Assist malfunction

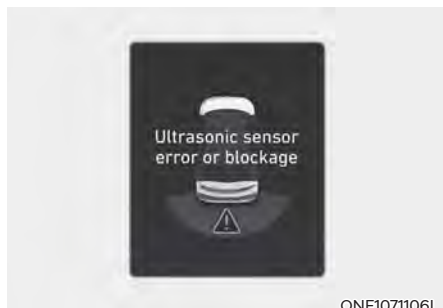

When Reverse Parking Collision-Avoidance Assist or other related functions are not working properly, the 'Check Parking Safety system' warning message will appear on the cluster, and Reverse Parking Collision-Avoidance Assist will turn off automatically. Have the vehicle be inspected by an authorized HYUNDAI dealer.

Reverse Parking Collision-Avoidance Assist disabled



The rear view camera is used as a detecting sensor to detect pedestrians. If the camera lens is covered with foreign material, such as snow or rain, it may adversely affect camera performance and Reverse Parking Collision-Avoidance Assist may not operate properly. Always keep the camera lens clean.



The rear ultrasonic sensors are located inside the rear bumper to detect objects in the rear area. If the sensors are covered with foreign material, such as snow or rain, it may adversely affect sensor performance and Reverse Parking Collision-Avoidance Assist may not operate properly. Always keep the rear bumper clean.

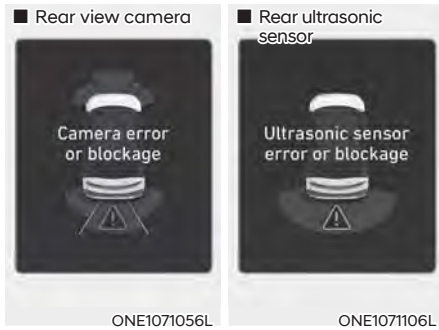

The 'Camera error or blockage' or 'Ultrasonic sensor error or blockage' warning message will appear on the cluster if the following situations occur:

- The rear view camera or rear ultrasonic sensor(s) is covered with foreign material, such as snow or rain, etc.
- There is inclement weather, such as heavy snow, heavy rain, etc.

If this occurs, Reverse Parking Collision-Avoidance Assist may turn off or may not operate properly. Check whether the rear view camera and rear ultrasonic sensors are clean.

Limitations of Reverse Parking Collision-Avoidance Assist

Reverse Parking Collision-Avoidance Assist may not assist braking or warn the driver even if there are pedestrians or objects under the following circumstances:

- Any non-factory equipment or accessory is installed
- Your vehicle is unstable due to an accident or other causes
- Bumper height or rear ultrasonic sensor installation has been modified
- Rear view camera or rear ultrasonic sensor(s) is damaged
- Rear view camera or the rear ultrasonic sensor(s) is stained with foreign material, such as snow, dirt, etc.
- Rear view camera is obscured by a light source or by inclement weather, such as heavy rain, fog, snow, etc.
- The surrounding is very bright or very dark
- Outside temperature is very high or very low
- The wind is either strong (above 12 mph (20 km/h)) or blowing perpendicular to the rear bumper
- Objects generating excessive noise, such as vehicle horns, loud motorcycle engines or truck air brakes, are near your vehicle
- An ultrasonic sensor with similar frequency is near your vehicle
- There is ground height difference between the vehicle and the pedestrian
- The image of the pedestrian in the rear view camera is indistinguishable from the background

- The pedestrian is near the rear edge of the vehicle
 - The pedestrian is not standing upright
 - The pedestrian is either very short or very tall for Reverse Parking Collision-Avoidance Assist to detect
 - The pedestrian or cyclist is wearing clothing that easily blends into the background, making it difficult to detect
 - The pedestrian is wearing clothing that does not reflect ultrasonic waves well
 - Size, thickness, height, or shape of the object does not reflect ultrasonic waves well (for example, pole, bush, curbs, carts, edge of a wall, etc.)
 - The pedestrian or the object is moving
 - The pedestrian or the object is very close to the rear of the vehicle
 - A wall is behind the pedestrian or the object
 - The object is not located at the rear center of your vehicle
 - The object is not parallel to the rear bumper
 - The road is slippery or inclined
 - The driver backs up the vehicle immediately after shifting to R (Reverse)
 - The driver accelerates or circles the vehicle
- Reverse Parking Collision-Avoidance Assist may unnecessarily warn the driver or assist with braking even if there are no pedestrians or objects under the following circumstances:
- Any non-factory equipment or accessory is installed
 - Your vehicle is unstable due to an accident or other causes
 - Bumper height or rear ultrasonic sensor installation has been modified
 - Your vehicle height is low or high due to heavy loads, abnormal tire pressure, etc.
 - Rear view camera or the rear ultrasonic sensor(s) is stained with foreign material, such as snow, dirt, etc.
 - The pattern on the road is mistaken for a pedestrian
 - There is shadow or light reflecting on the ground
 - Pedestrians or objects are around the path of the vehicle
 - Objects generating excessive noise, such as vehicle horns, loud motorcycle engines or truck air brakes, are near your vehicle
 - Your vehicle is backing towards a narrow passage or parking space
 - Your vehicle is backing towards an uneven road surface, such as an unpaved road, gravel, bump, gradient, etc.
 - A trailer or carrier is installed on the rear of your vehicle
 - An ultrasonic sensor with similar frequency is near your vehicle

 **WARNING**

Take the following precautions when using Reverse Parking Collision-Avoidance Assist:

- Always pay extreme caution while driving. The driver is responsible for controlling the brake for safe driving.
- Always pay attention to road and traffic conditions while driving, whether or not there is a warning.
- Always look around your vehicle to make sure there are no pedestrians or objects before moving the vehicle.
- The performance of Reverse Parking Collision-Avoidance Assist may vary under certain conditions. If vehicle speed is above 2 mph (4 km/h), Reverse Parking Collision-Avoidance Assist will provide collision avoidance assist only when pedestrians are detected. Always look around and pay attention when backing up your vehicle.
- Some objects may not be detected by the rear ultrasonic sensors due to the objects distance, size or material, all of which can limit the effectiveness of the sensor.
- Reverse Parking Collision-Avoidance Assist may not operate properly or may operate unnecessarily depending on the road conditions and the surroundings.
- Do not solely rely on Reverse Parking Collision-Avoidance Assist. Doing so may lead to vehicle damage or injuries.

 **CAUTION**

- Noise may be heard when sudden braking occurs to avoid a collision.
- If any other warning sound such as the seat belt warning chime is already generated, Reverse Parking Collision-Avoidance Assist warning may not sound.
- Reverse Parking Collision-Avoidance Assist may not work properly if the bumper has been damaged, replaced or repaired.
- Reverse Parking Collision-Avoidance Assist may not operate properly if interfered by strong electromagnetic waves.
- Playing the vehicle audio system at high volume may prevent passengers from hearing Reverse Parking Collision-Avoidance Assist warning sounds.
- Turn off Reverse Parking Collision-Avoidance Assist when towing a trailer. If towing and moving in reverse, Reverse Parking Collision-Avoidance Assist will activate as it detects the trailer.
- The brake control may not operate properly depending on the status of ESC (Electronic Stability Control).
There will only be a warning when:
 - The ESC (Electronic Stability Control) warning light is on
 - ESC (Electronic Stability Control) is engaged in a different function



CAUTION

Take the following precautions to maintain optimal performance of the detecting sensors:

- Always keep the rear view camera and rear ultrasonic sensors clean.
- Do not use any cleanser containing acid or alkaline detergents when cleaning the rear view camera lens. Use only a mild soap or neutral detergent, and rinse thoroughly with water.
- Do not spray the rear view camera or the rear ultrasonic sensors or their surrounding area directly with a high pressure washer. It may cause the rear view camera or the rear ultrasonic sensors to malfunction.
- Do not apply objects, such as a bumper sticker or a bumper guard, near the rear view camera or rear ultrasonic sensors or apply paint to the bumper. Doing so may adversely affect the performance of Reverse Parking Collision-Avoidance Assist.
- Never disassemble or apply impact on the rear view camera or the rear ultrasonic sensors components.
- Do not apply unnecessary force on the rear view camera or the rear ultrasonic sensors. Reverse Parking Collision-Avoidance Assist may not operate properly if the rear view camera or the rear ultrasonic sensor(s) is forcibly moved out of proper alignment. Have the vehicle be inspected by an authorized HYUNDAI dealer.



Information



Reverse Parking Collision-Avoidance Assist can detect a pedestrian or an object when:

- A pedestrian is standing behind the vehicle
- A large obstacle, such as a vehicle, is parked in the rear center of your vehicle

REMOTE SMART PARKING ASSIST (RSPA) (IF EQUIPPED)

Remote Smart Parking Assist uses vehicle sensors to help the driver park and exit parking spaces remotely from outside the vehicle by controlling the steering wheel, vehicle speed and gearshifts.

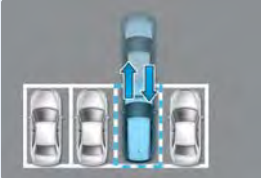
- Remote Smart Parking and Remote Operation function may be operated from outside the vehicle using the smart key.
- Smart Parking and Remote Smart Parking function may be operated from inside the vehicle.
- Smart Parking and Remote Smart Parking function helps the driver with perpendicular reverse parking and parallel reverse parking.
- Smart Exit function helps the driver with parallel forward exit.
- When Remote Smart Parking Assist operates, Parking Distance Warning, Rear View monitor and Surround View Monitor will also operate. For more details, refer to “Parking Distance Warning (PDW)”, “Rear View Monitor (RVM)” and “Surround View Monitor (SVM)” sections in this chapter.

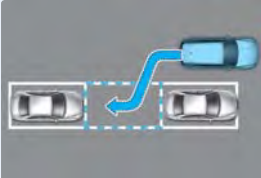
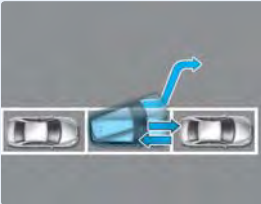
Function	Description
Remote Operation	<p>Remotely moving forward or backward</p>  <p>OJX1079037</p>
Smart Parking or Remote Smart Parking	<p>Perpendicular reverse parking</p>  <p>OJX1079034</p>
	<p>Parallel reverse parking</p>  <p>OJX1079035</p>
Smart Exit	<p>Parallel forward exit</p>  <p>OJX1079036</p>

Detecting sensors

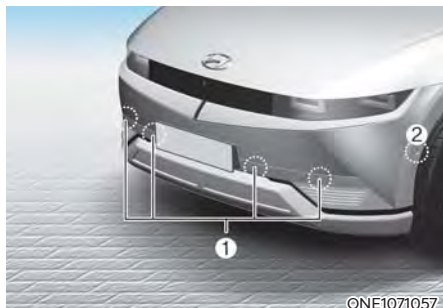

ONE1071057

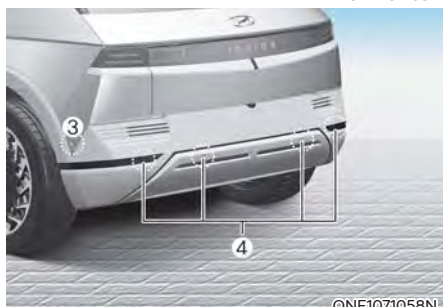

ONE1071058N

- [1] : Front ultrasonic sensors,
 [2] : Front corner ultrasonic sensors,
 [3] : Rear corner ultrasonic sensors,
 [4] : Rear ultrasonic sensors

Refer to the picture above for the detailed location of the detecting sensors.



CAUTION

Take the following precautions to maintain optimal performance of the detecting sensors:

- **Never disassemble the detecting sensor or sensor assembly, or cause any damage to it.**
- **If the detecting sensors need repair, have the vehicle be inspected by an authorized HYUNDAI dealer.**

- **Remote Smart Parking Assist may malfunction if the vehicle bumper height or ultrasonic sensor installation has been modified or damaged. Any non-factory installed equipment or accessories may also interfere with the sensor performance.**
- **When the ultrasonic sensor is frozen or stained with snow, dirt, or water, the sensor may not operate until the stains are removed using a soft cloth.**
- **Do not push, scratch or strike the ultrasonic sensor. Sensor damage could occur.**
- **Do not spray the ultrasonic sensors or its surrounding area directly with a high pressure washer.**

Remote Smart Parking Assist Settings

Settings features

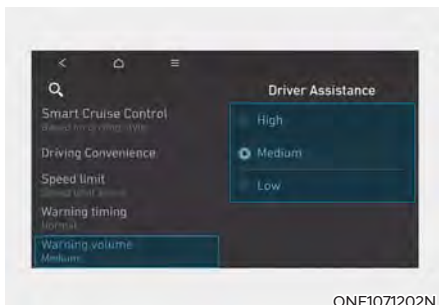

ONE1071202N

Warning Volume





With the vehicle on, select 'Driver Assistance → Warning Volume' from the Settings menu to change the Warning Volume to 'High', 'Medium' or 'Low' for Remote Smart Parking Assist.

If you change the warning volume, the Warning Volume of other Driver Assistance systems may change.

Remote Smart Parking Assist Operation

Remote Smart Parking Assist button



Location	Name	Symbol	Description
Inside vehicle	Parking/View button		<ul style="list-style-type: none"> Press and hold the Parking/View button to turn on Remote Smart Parking Assist. Also, Forward/Reverse Parking Distance warning will automatically turn on. However, functions may differ depending on the situations. Refer to each function's description for more details in the following pages. Press and hold the Parking/View button while Smart Parking or Smart Exit function is on to operate the function.
	Parking Safety button		<ul style="list-style-type: none"> Press the Parking Safety button while Remote Smart Parking Assist is operating to end Remote Smart Parking Assist operation.
Smart key	Remote Start button		<ul style="list-style-type: none"> Press the Remote Start button after the door is locked with the vehicle off to start the vehicle remotely. Press the Remote Start button while Remote Smart Parking or Remote Operation function is operating to end function operation.
	Forward button		<ul style="list-style-type: none"> When using Remote Smart Parking function, regardless of which direction button is pressed, parking is supported while the button is pressed.
	Backward button		<ul style="list-style-type: none"> When using the Remote Operation function, the vehicle moves in the direction of the button while the button is pressed.

Remote Operation

Operating order

Remote Operation operates in the following order:

1. Getting ready to remotely move forward and backward
2. Remotely moving forward and backward

1. Getting ready to remotely move forward and backward

There are two ways to operate Remote Operation function.



Method (1) Using the function with vehicle off

- (1) Within a certain range from the vehicle press the door lock (🔒) button on the smart key and lock all doors.
 - (2) Press and hold the Remote Start button (🔌) within 4 seconds until the vehicle starts.
- For more details on remotely starting the vehicle, refer to “Remote Start” section in chapter 6.

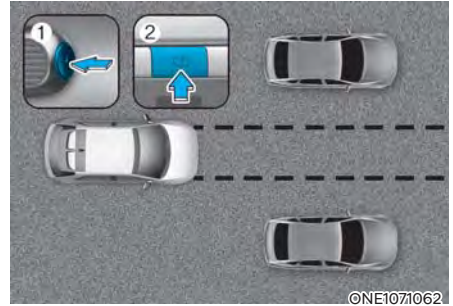

Method (2) Using the function with vehicle on

- (1) Park the vehicle in front of the space where you want to use Remote Operation function, and shift the gear to P (Park).
- (2) Press and hold the Parking/View (P) button to turn on Smart Parking Assist. A message ‘Under Remote Control’ will appear on the infotainment system screen.
- (3) Get out of the vehicle with the smart key and close all doors.

- 'Agree' must be selected on the infotainment system screen and the infotainment system has to operate properly to use Remote Operation function.
- Method (2) can be used after the vehicle has been driven above 3 mph (5 km/h).
- If the function is turned on again after parallel parking is completed by Remote Smart Parking Assist, Remote Operation function can be used with Method (2).

2. Remotely moving forward and backward



- (1) Press and hold one of the Forward (⏩) or Backward (⏪) button on the smart key. Remote Smart Parking Assist will automatically control the steering wheel, vehicle speed and gearshift. The vehicle will move in the direction of the button pressed.
 - (2) While Remote Operation function is operating, if you do not hold down the Forward (⏩) or Backward (⏪) button, the vehicle will stop and function control will pause. The function will start operating again when the button is pressed and held again.
 - (3) When the vehicle reaches the target location, release the smart key Forward (⏩) or Backward (⏪) button.
 - (4) When the driver gets in the vehicle with the smart key, a message will appear informing the driver Remote Operation function is complete on the infotainment system screen and the vehicle will remain on.
- In addition, when the Remote Start (⏻) button is pressed on the smart key from outside the vehicle, a message will appear informing the driver Remote Operation function is complete and the vehicle will turn off.

- Check that all smart keys are outside the vehicle when using Remote Operation function.
- Remote Operation function will operate only when the smart key is within 13 ft. (4 m) from the vehicle. If there is no vehicle movement even when the Forward (⏪) or Backward (⏩) button is pressed on the smart key, check the distance to the vehicle and press the button again.
- The detecting range of the smart key may vary depending on the surroundings that are affected by radio waves such as transmission tower, broadcast station, etc.
- When remotely moving forward using method (1), it is recognized as an exit situation, and the vehicle moves 13 ft. (4 m) to check for pedestrians, animals or objects around the vehicle. After confirmation, the steering wheel is controlled according to the condition ahead.
- When remotely moving forward using method (2), it is recognized as a parking situation, and will immediately control the steering wheel according to the condition ahead to assist with entering the parking space and aligning the vehicle. However, performance may reduce depending on the pedestrians, animals, shape of objects, location, etc., around the vehicle.
- For moving remotely backward, both method (1) and (2) aligns the steering wheel first, and then will only move the vehicle straight.
- When remotely moving forward or backward is completed, the vehicle will automatically shift to P (Park) and engage EPB (Electronic Parking Brake).



CAUTION

- **When using Remote Operation function, make sure that all passengers have gotten out of the vehicle.**
- **If the vehicle's battery is discharged or Remote Smart Parking Assist malfunctions when parked in a narrow parking space, Remote Operation function will not operate. Always park your vehicle in a space wide enough for you to get in or out of your vehicle.**
- **Please note that depending on the parking space, you may not be able to exit from the space you have entered by using Remote Operation function.**
- **After parking, the surrounding may change due to the movement of surrounding vehicles. If this occurs, Remote Operation function may not operate.**
- **Before leaving the vehicle, close windows and vision roof, and make sure the vehicle is off before locking the doors.**

Remote Operation function operation status

Operation status	Smart key LED	Hazard warning light
Under control	Green LED continuously blinks	-
Pause	Red LED continuously blinks	Blinks
Off	Red LED illuminates for 4 seconds and then turns off	Blinks 3 times and turns off
Complete	Green LED illuminates for 4 seconds and then turns off	Blinks 1 time and turns off

* Operation status by the hazard warning light may not be applicable based on the regulation of your country.

* If the smart key is not within the operating range from the vehicle (approximately 13 ft. (4m)), the smart key LED will not illuminate or blink. Use the smart key within the operating range.

How to turn off Remote Operation function while operating

- Press the Parking/View (P) button while the infotainment system screen guides the driver using method 2.
- Shift the gear except to P (Park) while the infotainment system screen guides the driver using method 2.
- Press the Parking Safety (P) button or select 'Cancel' on the infotainment system screen.
- Press the Remote Start (HOLD) button on the smart key while the vehicle is being controlled by Remote Operation function. Remote Operation function will turn off. At this time, the vehicle will turn off.
- Get on the vehicle with the smart key. Remote Operation function will turn off. At this time, the vehicle will remain on.

The function will pause in the following conditions when:

- There is a pedestrian, animal or object in the direction the vehicle is moving
- The door or liftgate is open
- The Forward (F) or Backward (B) button is not continuously pressed
- Simultaneously pressing multiple buttons on a smart key
- The smart key is not operated within 13 ft. (4 m) from the vehicle
- Button of another smart key is pressed in addition to the operating smart key (Excluding start button)
- Blind-Spot Collision-Avoidance Assist or Rear Cross-Traffic Collision-Avoidance Assist operates while the vehicle is being controlled in the reverse direction.

- The vehicle moves 22 ft. (7 m) while the smart key is pressed with Remote Operation function (maximum travel distance per button press)

When Remote Operation function is paused, the vehicle will stop. If the condition that made the function to pause disappears, the function may operate again.

The function will cancel in the following conditions when:

- The steering wheel is steered
- The gear is shifted while the vehicle is moving
- Operating EPB while the vehicle is moving
- The vehicle hood is open
- The brake pedal or accelerator pedal is depressed when all the doors are closed
- The smart key is outside the vehicle when the brake pedal is depressed while the driver's door is open
- Rapid acceleration occurs
- Vehicle skid occurs
- The wheel is stuck by an obstacle and cannot move
- Approximately 3 minutes and 50 seconds has passed after Remote Operation function has started to operate
- The slope of the road exceeds the operational range
- The function is paused for more than 1 minute
- The total travel distance of the vehicle has exceeded 45 ft. (14 m) after Remote Operation function operation
- The steering wheel, gearshift, braking, and drive controls are not working properly
- There is a problem with the smart key or the smart key battery is low
- ABS, TCS or ESC system operates due to slippery road conditions
- The alarm of the Theft Alarm System sounds
- The Charging door opens
- The EV mode is utility mode

When Remote Operation function is canceled, the vehicle will automatically stop, shift the gear to P (Park) and engage EPB (Electronic Parking Brake).

Smart Parking, Remote Smart Parking

Operating order

Parking function operates in the following order:

1. Getting ready for parking
 2. Searching for parking space
 3. Select parking type and operating mode
 4. Smart Parking
 5. Remote Smart Parking
- Parking function includes Smart Parking and Remote Smart Parking.

1. Getting ready for parking

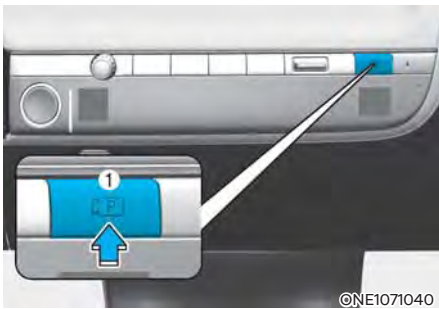

- (1) With the vehicle turned on, depress the brake pedal and shift the gear to D (Drive) or N (Neutral).
 - (2) Press and hold the Parking/View (P) button to turn on Remote Smart Parking Assist.
- 'Agree' must be selected on the infotainment system screen and the infotainment system has to operate properly to use Parking function.
 - If you drive above 3 mph (5 km/h) with the vehicle on, you may use the Parking function with the gear shifted to N (Neutral).

2. Searching for parking space



- (1) Slowly drive forward maintaining the distance of approximately 40 in. (100 cm) from the parked vehicles.
- (2) When searching for a parking space is complete, a message will appear on the infotainment system screen with an audible sound to notify the search is complete.
- (3) 'Select Parking Type' will be displayed on the infotainment system screen and the selected parking space will appear on Top View screen of Surround View Monitor.

- Remote Smart Parking Assist searches for parking spaces that are next to parked vehicles, or parking spaces with parked vehicles in front or rear.
- While searching for a parking space, when vehicle speed is above 12 mph (20 km/h), a message will appear on the infotainment system screen informing you to slow down. When vehicle speed is above 18 mph (30 km/h), Parking function will turn off.
- Searching for a parking space will be completed when there is enough space to move the vehicle in addition to the parking space.
- Even if an audible sound is heard to notify that searching for a parking space is complete, search completion can be canceled immediately depending on surroundings.

i Information

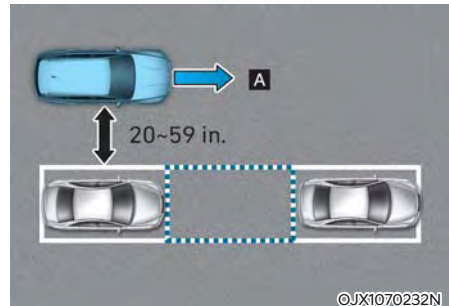

[A] : Searching for parking space

- **If the distance is below 20 in. (50 cm) or over 59 in. (150 cm), Remote Smart Parking Assist may not be able to search for a parking space.**
- **If you do not maintain a certain distance from the parked vehicle, the performance to search for a parking space may reduce.**
- **Even if a diagonal parking space is searched as a parking space, parking is not assisted properly.**
- **Due to abnormal performance of the ultrasonic sensor or the influence of the surroundings, Parking function may not be able to search for a parking space even if there is a parking space, or may search for a space that is not suitable for parking.**

3. Select parking type and operating mode



ONE1071218L

- (1) Parking type – Perpendicular reverse (Left/Right), Parallel reverse (Left/Right)

With the vehicle stopped by depressing the brake pedal, touch the infotainment system screen to select the desired parking type.

- If you continue to drive without stopping after the parking type selection screen appears, Remote Smart Parking Assist will return to the previous stage and search for a parking space.
- If Parking function is canceled unintentionally by pressing the Parking/View (P) button before the parking type is selected, you can return to the parking type selection stage by pressing and holding the button again while the vehicle is stopped.

CAUTION

Before selecting the Parking type, the driver should check whether the parking space is suitable.

If the searched parking space by Remote Smart Parking Assist is narrow or unsuitable for parking, do not select the Parking type and move the vehicle to search for another parking space.



ONE1071219L

- (2) Operating mode – Remote Parking, Smart Parking

After selecting a parking type, the infotainment system screen will guide you with Remote Smart Parking function and Smart Parking function. Follow the instructions to operate Remote Smart Parking Assist.

- Operating instructions will be displayed on the screen for each desired function you select.
- Do not take your foot off the brake pedal during the Parking function guide. When the vehicle moves, Remote Smart Parking Assist will turn off.

i Information



If Remote Smart Parking Assist cannot activate Remote Smart Parking function, only the Smart Parking guide will be displayed on the infotainment system screen.

4. Smart Parking



- (1) Press the Parking/View (P) button when the vehicle is stopped by depressing the brake pedal. When the brake pedal is released, Remote Smart Parking Assist will automatically control the steering wheel, vehicle speed and gearshift.
- (2) While Smart Parking function is operating, if you do not hold down the Parking/View button, the vehicle will stop and function control will pause. The function will start operating again when the Parking/View button is pressed and held again.
- (3) When the vehicle reaches the target parking position, a message will appear on the infotainment system screen to inform you that parking is complete.

- Smart Parking function will not operate if the door is open or the seat belt is not fastened.
- The parking location indicator is displayed on Surround View Monitor screen and is displayed until the vehicle enters the parking space for the first time by Smart Parking function.
- Vehicle speed can be adjusted by depressing the brake pedal while Smart Parking function is operating. However, the vehicle does not accelerate even when the accelerator pedal is depressed.
- Depending on parking environments, if the vehicle is stopped by a stopper, parking may be completed.
- If you need to change the vehicle's position or location, manually complete parking your vehicle.

5. Remote Smart Parking



- (1) Shift the gear to P (Park), get out of the vehicle with the smart key, and close all doors.
- (2) Press and hold one of the Forward (⏪) or Backward (⏩) button on the smart key. Remote Smart Parking Assist will automatically control the steering wheel, vehicle speed and gearshift.
- (3) While Remote Smart Parking function is operating, if you do not hold down the Forward (⏪) or Backward (⏩) button, the vehicle will stop and function control will pause. The function will start operating again when the button is pressed and held again.
- (4) When the vehicle reaches the target parking position, a message will appear on the infotainment system screen to inform you that parking is complete. The vehicle will automatically shift to P (Park), engage EPB (Electronic Parking Brake) and the vehicle will turn off.



- When operating Remote Smart Parking function, make sure all smart keys are outside of the vehicle.
- Remote Smart Parking function will operate only when the smart key is within 13 ft. (4 m) from the vehicle. If there is no vehicle movement even when the Remote Operation button is pressed on the smart key, check the distance to the vehicle and press the button again.
- The detecting range of the smart key may vary depending on the surroundings that are affected by radio waves such as transmission tower, broadcast station, etc.
- The parking location indicator is displayed on Surround View Monitor screen and is displayed until the vehicle enters the parking space for the first time by Remote Smart Parking function.
- Depending on parking environments, if the vehicle is stopped by a stopper, parking may be completed.
- If you need to change the vehicle's position or location, manually complete parking your vehicle.



CAUTION

- **When using Remote Smart Parking function, make sure that all passengers have gotten out of the vehicle.**
- **After ending or turning off Remote Smart Parking function, before leaving the vehicle, close windows and vision roof, and make sure the vehicle is off before locking the doors.**

How to turn off Parking function while operating

- Press the Parking/View () button in the following stage:
 - Searching for parking space
 - Select parking type
- Shift the gear to R (Reverse) in the following stage:
 - Searching for parking space
 - Select parking type
 - Select operating mode
- Press the Parking Safety () button or select 'Cancel' on the infotainment system screen to turn off Parking function.
- While Smart Parking function is operating:
 - If the vehicle is stopped by depressing the brake pedal, and the gear is shifted, Parking function will turn off. At this time, EPB (Electronic Parking Brake) will not be engaged.
- While Remote Smart Parking function is operating:
 - Press the Remote Start () button on the smart key. Parking function will turn off.
 - Get on the vehicle with the smart key. Parking function will turn off. At this time, the vehicle will remain on.

Parking function operation status

- Smart Parking function

Operation status	Turn signal
Under control	The turn signal of the parking direction blinks until the first reverse is complete.

- Smart Parking function

Operation status	Smart key LED	Hazard warning light	Turn signal
Under control	Green LED continuously blinks	-	The turn signal of the parking direction blinks until the first reverse is complete.
Pause	Red LED continuously blinks	Blinks	-
Off	Red LED illuminates for 4 seconds and then turns off	Blinks 3 times and turns off	-
Complete	Green LED illuminates for 4 seconds and then turns off	Blinks 1 time and turns off	-

* Operation status by the hazard warning light may not be applicable based on the regulation of your country.

* If the smart key is not within the operating range from the vehicle (approximately 13 ft. (4 m)), the smart key LED will not illuminate or blink. Use the smart key within the operating range.

The function will pause in the following conditions when:

- Smart Parking
 - There is a pedestrian, animal or object in the direction the vehicle is moving
 - The door or liftgate is open
 - The driver's seat belt is not fastened
 - Blind-Spot Collision-Avoidance Assist or Rear-Cross Traffic Collision-Avoidance Assist operates while the vehicle is being controlled in the reverse direction
 - The Parking/View (P) button is not continuously pressed
 - The vehicle is stopped by depressing the brake pedal
- Remote Smart Parking
 - There is a pedestrian, animal or object in the direction the vehicle is moving
 - The door or liftgate is open
 - The Forward (F) or Backward (B) button is not continuously pressed
 - Simultaneously pressing multiple buttons on a smart key
 - The smart key is not operated within 13 ft. (4 m) from the vehicle
 - Button of another smart key is pressed in addition to the operating smart key
 - Blind-Spot Collision-Avoidance Assist or Rear-Cross Traffic Collision-Avoidance Assist operates while the vehicle is being controlled in the reverse direction

When Parking function is paused, the vehicle will automatically stop. If the condition that made the function to pause disappears, the function may operate again.

The function will cancel in the following conditions when:

- Smart Parking
 - The steering wheel is steered
 - The gear is shifted while the vehicle is moving
 - Operating EPB while the vehicle is moving
 - The hood is open
 - The driver opens the door with the seatbelt unfastened
 - Rapid acceleration occurs
 - Vehicle skid occurs
 - The wheel is stuck by an obstacle and cannot move
 - There are pedestrians, animals or objects at the front and rear of the vehicle at the same time
 - Approximately 3 minutes and 50 seconds have past after Smart Parking function has started to operate
 - The slope of the road exceeds the operational range
 - The function is paused for more than 1 minute
 - The steering wheel, gearshift, braking, and drive controls are not working properly
 - ABS, TCS or ESC system operates due to slippery road conditions
 - The Charging door opens
 - The EV mode is utility mode

When Smart Parking function is canceled, the vehicle will automatically stop, shift the gear to P (Park) and engage EPB (Electronic Parking Brake).

- Remote Smart Parking
 - The steering wheel is steered
 - The gear is shifted
 - Operating EPB while the vehicle is moving
 - The hood is open
 - The brake pedal or accelerator pedal is depressed when all the doors are closed
 - The smart key is outside the vehicle when the brake pedal is depressed while the driver's door is open.
 - Rapid acceleration occurs
 - Vehicle skid occurs
 - The wheel is stuck by an obstacle and cannot move
 - There are pedestrians, animals or objects at the front and rear of the vehicle at the same time
 - Approximately 3 minutes and 50 seconds have past after Remote Smart Parking function has started to operate
 - The slope of the road exceeds the operational range
 - The function is paused for more than 1 minute
 - The steering wheel, gearshift, braking, and drive controls are not working properly
 - There is a problem with the smart key or the smart key battery is low
 - ABS, TCS or ESC system operates due to slippery road conditions
 - The alarm of the Theft Alarm System sounds
 - The Charging door opens
 - The EV mode is utility mode

When Remote Smart Parking function is canceled, the vehicle will automatically stop, shift the gear to P (Park) and engage EPB (Electronic Parking Brake).

Smart Exit

Operating order

Smart Exit function operates in the following order:

1. Getting ready for exit
2. Checking space
3. Select exit direction
4. Smart Exit

1. Getting ready for exit

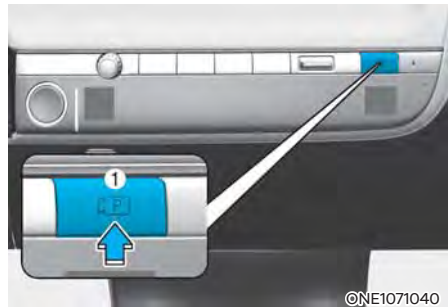

- (1) With the vehicle turned on, depress the brake pedal and shift the gear to P (Park) or N (Neutral).
 - (2) Press and hold the Parking/View (P) button to turn on Remote Smart Parking Assist.
- 'Agree' must be selected on the infotainment system screen and the infotainment system has to operate properly to use Smart Smart Exit function.
 - Drive below 3 mph (5 km/h) with the vehicle on and shift the gear to N (Neutral), Smart Exit function can be used.
 - If the function is turned on again after parallel parking is completed by Remote Smart Parking Assist, Smart Exit function can be used.

2. Checking space



- (1) When the vehicle is stopped by depressing the brake pedal, the vehicle sensors will detect the distance from nearby objects and check for space to exit.
- (2) When checking for space is complete, a message will appear on the infotainment system screen with an audible sound to notify the search is complete.

WARNING

- **While checking for space, if there is a risk of collision with pedestrian, animal or object in the direction of vehicle exit, for your safety, Smart Exit function can be turned off.**
- **Even if check for space is completed, objects in the blind spot area cannot be detected by the sensors. The driver must directly check the blind spot area and continue using the function.**

Information

Due to abnormal performance of the ultrasonic sensor or the influence of the surroundings, Parking function may not be able to search for a parking space even if there is a parking space, or may search for a space that is not suitable for parking.

- The parked vehicle has objects attached to the bumper such as bumper guard, trailer hitch, etc.

3. Select exiting direction



- (1) With the vehicle stopped by depressing the brake pedal, the infotainment system screen displays the possible directions for parallel exit.
- (2) Touch the infotainment system screen to select the desired exit direction.

CAUTION

- **Before selecting the Exit Direction, the driver should check whether the space for exit is suitable.**
- **If the searched exit space by Remote Smart Parking Assist is narrow or unsuitable (surrounding vehicles are parked vertically, etc.), do not use the Smart Exit function.**

4. Smart Exit





- (1) Press the Parking/View (P) button when the vehicle is stopped by depressing the brake pedal. When the brake pedal is released, Remote Smart Parking Assist will automatically control the steering wheel, vehicle speed and gearshift.
- (2) While Smart Exit function is operating, if you do not hold down the Parking/View button, the vehicle will stop and function control will pause. The function will start operating again when the Parking/View button is pressed and held again.
- (3) When the vehicle reaches the target exit location, a message will appear on the infotainment system screen to inform you that exit is complete.

- Smart Exit function will not operate if the door is open or the seat belt is not fastened.
- Vehicle speed can be adjusted by depressing the brake pedal while Smart Exit function is operating. However, the vehicle does not accelerate even when the accelerator pedal is depressed.
- If exit is completed while depressing the brake pedal, Smart Exit function will complete with the gear in D (Drive).
- If exit is completed while depressing the accelerator pedal, you must take your foot off the accelerator pedal once for the accelerator pedal to operate.
- If there is no vehicle operation such as depressing the brake pedal or accelerator pedal within 4 seconds after exit is complete, the vehicle will automatically shift to P (Park) and engage EPB (Electronic Parking Brake).
- After Exit function is complete, always check the surroundings before driving.

Smart Exit operation status

Operation status	Turn signal
Under control	The turn signal of the exit direction blinks until the exit is complete or Smart Exit is canceled.

How to turn off Smart function while operating

- Press the Parking/View () button in the following stage:
 - Checking space
 - Select exit direction
- Shift the gear to R (Reverse) in the following stage:
 - Checking space
 - Select exit direction
- Press the Parking Safety () button or select 'Cancel' on the infotainment system screen to turn off Exit function.
- While Smart Exit function is operating, if the vehicle is stopped by depressing the brake pedal, and the gear is shifted, Exiting function will turn off. At this time, EPB (Electronic Parking Brake) will not be engaged.

The function will pause in the following conditions when:

- There is a pedestrian, animal or object in the direction the vehicle is moving
- The door or liftgate is open
- The driver's seat belt is not fastened
- Blind-Spot Collision-Avoidance Assist or Rear-Cross Traffic Collision-Avoidance Assist operates while the vehicle is being controlled in the reverse direction
- The Parking/View () button is not continuously pressed
- The vehicle is stopped by depressing the brake pedal

When Exit function is paused, the vehicle will stop. If the condition that made the function to pause disappears, the function may operate again.

The function will cancel in the following conditions when:

- Smart Exit
 - The steering wheel is steered
 - The gear is shifted while the vehicle is moving
 - Operating EPB while the vehicle is moving
 - The hood is open
 - The driver opens the door with the seatbelt unfastened
 - Rapid acceleration occurs
 - Vehicle skid occurs
 - The wheel is stuck by an obstacle and cannot move
 - There are pedestrians, animals or objects at the front and rear of the vehicle at the same time
 - Approximately 3 minutes and 50 seconds have past after Smart Exit function has started to operate
 - The slope of the road exceeds the operational range
 - The function was paused for more than 1 minute
 - The steering wheel, gearshift, braking, and drive controls are not working properly
 - ABS, TCS or ESC system operates due to slippery road conditions
 - The Charging door opens

When Smart Exit function is canceled, the vehicle will automatically stop, shift the gear to P (Park) and engage EPB (Electronic Parking Brake).

Remote Smart Parking Assist Malfunction and Limitations

Remote Smart Parking Assist malfunction



Remote Smart Parking Assist check

When Remote Smart Parking Assist is not working properly, the 'Check Parking Assist' warning message will appear on the infotainment system screen. If the message appears, stop using Remote Smart Parking Assist, and have the vehicle be inspected by an authorized HYUNDAI dealer.





Remote Smart Parking Assist canceled

When Remote Parking Assist is operating, the function can be canceled, and the 'Parking Assist Canceled' warning message may appear regardless of the parking order. Other messages may appear depending on the situations.

Follow the instructions provided on the infotainment system screen while parking your vehicle with Remote Parking Assist. Always look around and pay attention when using Remote Smart Parking Assist.



Remote Smart Parking Assist standby

When 'Parking Assist Conditions Not Met' message appears, when Parking/View () button has been pressed and held, Remote Smart Parking Assist is in standby. After a while, press and hold the Parking/View () button again to see if Remote Smart Parking Assist works.

The message appears even when the smart key's battery is low. Check the smart key battery level.

It does not work even when the EV mode is in the Utility mode. For related information refer to Utility Mode in 'Foreword/Electric Vehicle System Overview'.

Limitations of Remote Smart Parking Assist

In the following circumstances, Remote Smart Parking Assist performance to park or exit the vehicle may be limited, there may be a risk of collision, or Remote Smart Parking Assist may turn off. Park or exit the vehicle manually if necessary.

- An object is attached to the steering wheel
- The vehicle is installed with a snow chain, spare tire or different size wheel
- Tire pressure is lower or higher than the standard tire pressure
- Your vehicle is loaded with cargo longer or wider than your vehicle or a trailer is connected to your vehicle
- There is a problem with the wheel alignment
- Your vehicle is leaned severely to one side
- Your vehicle is equipped with a trailer hitch
- The license plate is installed differently from the original location
- There is a person, animal or object above or below the ultrasonic sensor when Remote Smart Parking Assist is activated
- The parking space is curved or diagonal
- There is an obstacle such as a person, animal or object (trash can, bicycle, motorcycle, shopping cart, narrow pillar, etc.) near the parking space
- There is a circular pillar or narrow pillar, or a pillar surrounded by objects such as fire extinguisher, etc., near the parking space
- The road surface is bumpy (curbstone, speed bump, etc.)
- The road is slippery
- The parking space is near a vehicle with higher ground clearance or big, such as a truck, etc.
- The parking space is Inclined
- There is heavy wind
- Operating Remote Smart Parking Assist on uneven roads, gravel roads, bushes, etc.
- The performance of the ultrasonic sensor is affected by extremely hot or cold weather
- The ultrasonic sensor is covered with snow or water
- An object that generates ultrasonic waves is nearby
- A wireless device with a transmission function operates near the ultrasonic sensors
- Your vehicle is affected by another vehicle's Parking Distance Warning
- The sensor is mounted or positioned incorrectly by an impact to the bumper
- When the ultrasonic sensor cannot detect the following objects:
 - Sharp or slim objects, such as ropes, chains or small poles
 - Objects smaller than 40 in. (100 cm) in length and narrower than 6 in. (14 cm) in diameter
 - Objects which tend to absorb sensor frequency, such as clothes, spongy material or snow
 - A narrow object such as a corner of a square pillar
 - Person, animal or object near the ultrasonic sensor

Remote Smart Parking Assist may not operate properly under the following circumstances:

- Parking on inclines

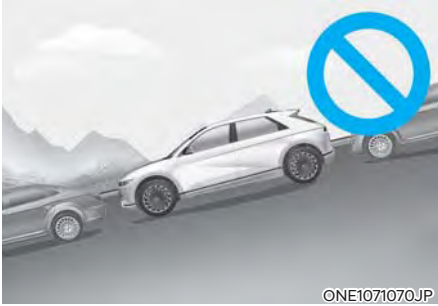

Park manually when parking on inclines.

- Parking in snow



Snow may interfere with sensor operation, or Remote Smart Parking Assist may cancel if the road is slippery while parking.

- Parking on uneven road



Remote Smart Parking Assist may cancel when the vehicle slips, or the vehicle cannot move due to road conditions such as pebbles or fragmented stones.

- Parking behind a truck

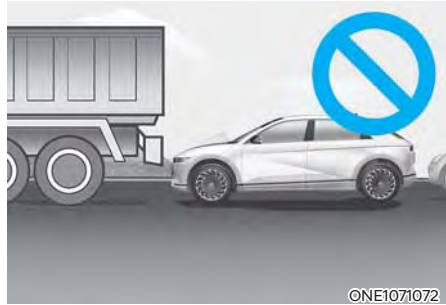

Do not use Remote Smart Parking Assist around vehicles with higher ground clearance, such as a bus, truck, etc. It may lead to an accident.

- Parking near a pillar



Remote Smart Parking Assist performance may reduce or collision with an obstacle may occur when there is a narrow object, circular pillar, square pillar, or a pillar surrounded by objects such as a fire extinguisher, etc., near the parking space. The driver should park the vehicle manually.

- Parking in a parking space with a vehicle on one side only



If Remote Smart Parking Assist is used, when parking in a parking space with a vehicle only on one side, your vehicle may cross the parking line to avoid the parked vehicle.

- Parking diagonal

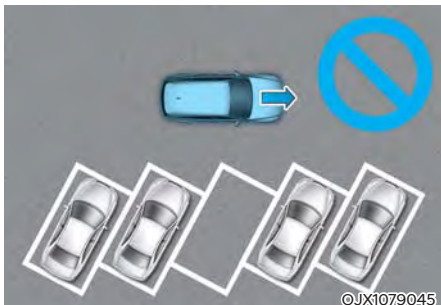

Remote Smart Parking Assist does not provide diagonal parking. Even if your vehicle was able to enter the parking space, do not use Remote Smart Parking Assist because the function cannot operate properly.

- Leaving a parking space near a wall or parking in a narrow space



- Remote Smart Parking Assist may not operate properly when leaving a parking space that is narrow and near a wall. Always check for pedestrians, animals, objects while leaving.
- For your safety, Remote Smart Parking Assist does not search for parking spaces at areas with narrow parking spaces that are narrower than the minimum space required for parking.

 **WARNING**

Take the following precautions when using Remote Smart Parking Assist:

- The driver is responsible for safe parking and exit when using Remote Smart Parking Assist.
- When using Remote Smart Parking Assist, stay out of the way in the direction the vehicle moves for your safety.
- Always check surroundings when using Remote Smart Parking Assist. You may collide with pedestrians, animals, or objects if they are near the sensor or are in the sensor's blind spot area.
- A collision may occur if a pedestrian, animal, or object suddenly appears while Remote Smart Parking Assist is operating.
- Do not use Remote Smart Parking Assist when under the influence of alcohol.
- Do not let children or other people to use the smart key.
- If Remote Smart Parking Assist is used continuously for a long period, it may adversely affect Remote Smart Parking Assist performance.

- Remote Smart Parking Assist may not operate properly if the vehicle does not wheel alignment adjustment such as when the vehicle tilts to one side. Have the vehicle be inspected by an authorized HYUNDAI dealer.
- Noise may be heard when braking occurs by Remote Smart Parking Assist or when the brake pedal is depressed by the driver.
- Remote Smart Parking Assist may suddenly apply the brake to avoid collision.
- Use Remote Smart Parking Assist only in a parking space that is large enough for the vehicle to move safely.

NOTICE

- If the 3rd stage warning (continuous beep) of the Forward/Reverse Parking Distance Warning sounds while Remote Smart Parking Assist is operating, it means the obstacle detected is close to your vehicle. At this time, Remote Smart Parking Assist will temporarily stop operating. Make sure there are no pedestrians, animals, or objects around your vehicle.
- Depending on brake operation, the stop lights may come on while the vehicle is moving.
- If the vehicle is remotely started that has been parked in cold weather for a long time, the operation of Remote Smart Parking function may be delayed or canceled depending on vehicle condition.

DECLARATION OF CONFORMITY (IF EQUIPPED)

Front Radar

The radio frequency components (front radar) complies:

- For USA, Micronesia, Dominican Republic and Honduras



- For Canada

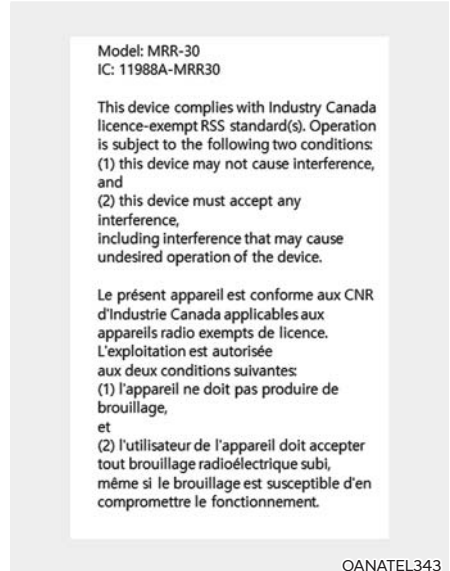

Rear Corner Radar

The radio frequency components (Rear Corner Radar) complies:

- For USA, Micronesia, Dominican Republic and Honduras



OANATEL352

- For Canada

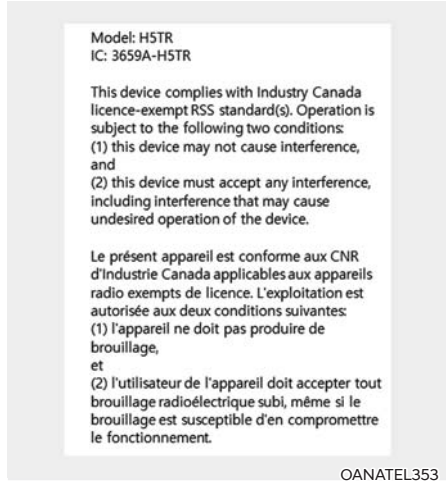

OANATEL353

8. Emergency Situations

Hazard Warning Flasher	8-2
In Case of an Emergency While Driving	8-2
If the Vehicle Stalls While Driving	8-2
If the Vehicle Stalls at A Crossroad or Crossing	8-2
If You Have a Flat Tire While Driving	8-3
If the Vehicle will not Start	8-3
Confirm the EV Battery is not Low on the Charge Gauge	8-3
Jump Starting (12V battery)	8-4
Tire Pressure Monitoring System (TPMS).....	8-7
Check Tire Pressure.....	8-7
Tire Pressure Monitoring System	8-8
Low Tire Pressure Warning Light.....	8-9
Low Tire Pressure Position and Tire Pressure Telltale.....	8-9
TPMS (Tire Pressure Monitoring System) Malfunction Indicator.....	8-10
Changing a Tire with TPMS	8-10
If You have a Flat Tire (with Tire Mobility Kit).....	8-12
Introduction.....	8-12
Notes on the Safe Use of the Tire Mobility Kit	8-13
Components of the Tire Mobility Kit.....	8-14
Using the Tire Mobility Kit When a Tire is Flat.....	8-15
How to Adjust Tire Pressure	8-18
Towing	8-19
Towing Service	8-19
Removable Towing Hook.....	8-20

HAZARD WARNING FLASHER

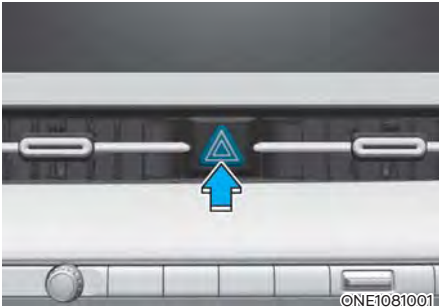

The hazard warning flasher serves as a warning to other drivers to exercise extreme caution when approaching, overtaking, or passing your vehicle. It should be used whenever emergency repairs are being made or when the vehicle is stopped near the edge of a roadway.

To turn the hazard warning flasher on or off, press the hazard warning flasher button with the Start/Stop button in any position. The hazard warning flasher button is located in the center fascia panel. All turn signal lights will flash simultaneously.

- The hazard warning flasher operates regardless of whether your vehicle is running or not.
- The turn signals do not work when the hazard flasher is on.

IN CASE OF AN EMERGENCY WHILE DRIVING

If the Vehicle Stalls While Driving

- Reduce your speed gradually, keeping a straight line. Move cautiously off the road to a safe place.
- Turn on your hazard warning flasher.
- Try to start the vehicle again. If your vehicle will not start, contact an authorized HYUNDAI dealer or seek other qualified assistance.

If the Vehicle Stalls at A Crossroad or Crossing

If the vehicle stalls at a crossroads or crossing, if safe to do so, shift the gear to N (Neutral) and then push the vehicle to a safe location.

To stay N (Neutral) while the vehicle is off, refer to 'To stay in N (Neutral) when vehicle is OFF' in chapter 6.

If You Have a Flat Tire While Driving

If a tire goes flat while you are driving:

- Take your foot off the accelerator pedal and let the vehicle slow down while driving straight ahead. Do not apply the brakes immediately or attempt to pull off the road as this may cause loss of vehicle control resulting in an accident. When the vehicle has slowed to such a speed that it is safe to do so, brake carefully and pull off the road. Drive off the road as far as possible and park on firm, level ground. If you are on a divided highway, do not park in the median area between the two traffic lanes.
- When the vehicle is stopped, press the hazard warning flasher button, shift the gear to P (Park), apply the parking brake, and press the Start/Stop button to the OFF position.
- Have all passengers get out of the vehicle. Be sure they all get out on the side of the vehicle that is away from traffic.
- When changing a flat tire, follow the instructions provided later in this chapter.

IF THE VEHICLE WILL NOT START

Confirm the EV Battery is not Low on the Charge Gauge

- Be sure the gear is in P (Park). The vehicle starts only when the gear is in P (Park).
- Check the 12-volt battery connections to be sure they are clean and tight.
- Turn on the interior light. If the light dims or goes out when you operate the starter, the 12V battery is drained.

Do not push or pull the vehicle to start it. This could cause damage to your vehicle.

JUMP STARTING (12V BATTERY)

Jump starting can be dangerous if done incorrectly. Follow the jump starting procedure in this section to avoid serious injury or damage to your vehicle. If in doubt about how to properly jump start your vehicle, have a service technician or towing service do it for you.

WARNING

To prevent **SERIOUS INJURY** or **DEATH** to you or bystanders, always follow these precautions when working near or handling the battery:



Always read and follow instructions carefully when handling a battery.



Wear eye protection designed to protect the eyes from acid splashes.



Keep all flames, sparks, or smoking materials away from the battery.



Hydrogen is always present in battery cells, is highly combustible, and may explode if ignited.



Keep batteries out of reach of children.



Batteries contain sulfuric acid which is highly corrosive. Do not allow acid to contact your eyes, skin or clothing.

If acid gets into your eyes, flush your eyes with clean water for at least 15 minutes and get immediate medical attention. If acid gets on your skin, thoroughly wash the area. If you feel pain or a burning sensation, get medical attention immediately.

- When lifting a plastic-cased battery, excessive pressure on the case may cause battery acid to leak. Lift with a battery carrier or with your hands on opposite corners.
- Do not attempt to jump start your vehicle if your battery is frozen.
- NEVER attempt to recharge the battery when the vehicle's battery cables are connected to the battery.
- The electrical ignition system works with high voltage.
NEVER touch these components with the vehicle running or when the Start/Stop button is in the ON position.
- The electrical ignition system works with high voltage. NEVER touch these components with the (READY) indicator ON or when the START/STOP button is in the ON position.
- Do not allow the (+) and (-) jumper cables to touch. It may cause sparks.
- The battery may rupture or explode when you jump start with a low or frozen battery.
- Do not directly connect the (-) to the jump cable. Connect the (-) to the one of the metallic parts located far from the jump cable in the vehicle. The direct (-) connection to the jump cable may cause an explosion.
- Be sure to use only 12V battery to jump start. Using batteries with other voltages to jump start can damage the battery or even provoke an explosion.

Jump starting procedure

i Information

When you jump start your vehicle, use the jumper terminal in the motor compartment.

1. Position the vehicles close enough that the jumper cables will reach, but do not allow the vehicle body parts to contact.
2. Avoid fans or any moving parts in the motor compartment at all times, even when the vehicles are turned off.
3. Turn off all electrical devices such as radios, lights, air conditioning, etc. Put the vehicles in P (Park) and set the parking brake. Turn both vehicles OFF.
4. Open the hood.
5. Remove the battery cover located inside of the front trunk.
6. Remove the motor compartment fuse box cover.

⚠ CAUTION

Before jump starting, make sure to correctly identify the positive (+) and negative (-) terminals to avoid reverse polarity connections.

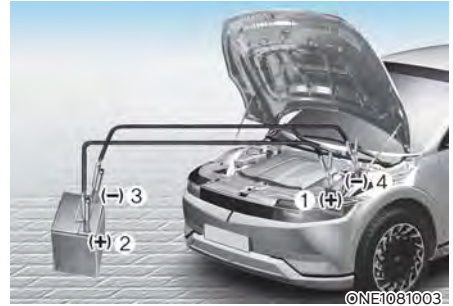

7. Connect the jumper cables in the exact sequence shown in the illustration. First connect one jumper cable to the red, positive (+) jumper terminal of your vehicle (1).
8. Connect the other end of the jumper cable to the red, positive (+) battery/jumper terminal of the assisting vehicle (2).
9. Connect the second jumper cable to the black, negative (-) battery/jumper terminal of the assisting vehicle (3).
10. Connect the other end of the second jumper cable to the black, negative (-) chassis ground of your vehicle (4).

Do not allow the jumper cables to contact anything except the correct battery or jumper terminals or the correct ground. Do not lean over the battery when making connections.

⚠ WARNING

Do not connect the jumper cable to the negative (-) jumper terminal of the discharged battery. A spark could cause the battery to explode and lead to a personal injury or vehicle damage.

11. Start the assisting vehicle and let it run at approximately for a few minutes. Then start your vehicle.
12. Keep your vehicle operating for at least 30 minutes at idle or driving to assure your battery receives enough charge to be able to start on its own after the vehicle is shut off. A completely discharged battery may require as long as 60 minutes runtime to fully recharge it. If the vehicle is run for less, battery may not restart.

If your vehicle will not start after a few attempts, it probably requires service. In this event please seek qualified assistance. If the cause of your battery discharging is not apparent, have your vehicle checked by an authorized HYUNDAI dealer.

Disconnect the jumper cables in the exact reverse order you connected them:

1. Disconnect the jumper cable from the black, negative (-) chassis ground of your vehicle (4).
2. Disconnect the other end of the jumper cable from the black, negative (-) battery/chassis ground of the assisting vehicle (3).
3. Disconnect the second jumper cable from the red, positive (+) battery/jumper terminal of the assisting vehicle (2).
4. Disconnect the other end of the jumper cable from the red, positive (+) jumper terminal of your vehicle (1).

Information



An inappropriately disposed battery can be harmful to the environment and human health. Dispose of the battery according to your local law(s) or regulations.

NOTICE

To prevent damage to your vehicle:

- Only use a 12-volt power supply (battery or jumper system) to jump start your vehicle.
- Do not attempt to jump start your vehicle by push-starting.
- Always be sure that the battery cover and cable are tightened after finishing jump start your vehicle. Otherwise it may cause damage to the relevant parts, noise trouble, or entrance of foreign substances.



CAUTION

While jump starting your vehicle, avoid the positive (+) and negative (-) cables to come in contact. A spark could cause personal injury.

TIRE PRESSURE MONITORING SYSTEM (TPMS)



ONE1081004L



ONE1081005L

- (1) Low Tire Pressure Telltale/TPMS Malfunction Indicator
- (2) Low Tire Pressure Position Telltale and Tire Pressure Telltale (Shown on the LCD display)

Check Tire Pressure



ONE1041010L

- You can check the tire pressure in the Utility view on the cluster.
- **Refer to the “View Modes” section in chapter 4.**
- Tire pressure is displayed after a few minutes of driving after initial vehicle start up.
- If tire pressure is not displayed when the vehicle is stopped, ‘Drive to display’ message will appear. After driving, check the tire pressure.
- The displayed tire pressure values may differ from those measured with a tire pressure gauge.
- You can change the tire pressure unit from the Settings menu in the infotainment system screen. Select:
 - Setup → General Settings → Unit → Tire Air Pressure Unit → psi/kPa/bar

For detailed information, refer to the separately supplied infotainment system manual.

Tire Pressure Monitoring System



WARNING

Over-inflation or under-inflation can reduce tire life, adversely affect vehicle handling, and lead to sudden tire failure that may cause loss of vehicle control resulting in an accident.

Each tire, including the spare (if provided), should be checked monthly when cold and inflated to the inflation pressure recommended by the vehicle manufacturer on the vehicle placard or tire inflation pressure label. (If your vehicle has tires of a different size than the size indicated on the vehicle placard or tire inflation pressure label, you should determine the proper tire inflation pressure for those tires.)

As an added safety feature, your vehicle has been equipped with a tire pressure monitoring system (TPMS) that illuminates a low tire pressure telltale when one or more of your tires is significantly under-inflated. Accordingly, when the low tire pressure telltale illuminates, you should stop and check your tires as soon as possible, and inflate them to the proper pressure. Driving on a significantly under-inflated tire causes the tire to overheat and can lead to tire failure.

Under-inflation also reduces fuel efficiency and tire tread life, and may affect the vehicle's handling and stopping ability.

Please note that the TPMS is not a substitute for proper tire maintenance, and it is the driver's responsibility to maintain correct tire pressure, even if under-inflation has not reached the level to trigger illumination of the TPMS low tire pressure telltale.

Your vehicle has also been equipped with a TPMS malfunction indicator to indicate when the system is not operating properly. The TPMS malfunction indicator is combined with the low tire pressure telltale. When the system detects a malfunction, the telltale will flash for approximately one minute and then remain continuously illuminated. This sequence will continue upon subsequent vehicle start-ups as long as the malfunction exists.

When the malfunction indicator is illuminated, the system may not be able to detect or signal low tire pressure as intended. TPMS malfunctions may occur for a variety of reasons, including the installation of replacement or alternate tires or wheels on the vehicle that prevent the TPMS from functioning properly.

Always check the TPMS malfunction telltale after replacing one or more tires or wheels on your vehicle to ensure that the replacement or alternate tires and wheels allow the TPMS to continue to function properly.

NOTICE

If any of the below happens, have the system checked by an authorized HYUNDAI dealer.

- 1. The Low Tire Pressure Telltale/ TPMS Malfunction Indicator does not illuminate for 3 seconds when the Start/Stop button is pressed to the ON position or when the vehicle is running.**
- 2. The TPMS Malfunction Indicator remains illuminated after blinking for approximately 1 minute.**
- 3. The Low Tire Pressure Position Telltale remains illuminated.**



Low Tire Pressure Warning Light

Low Tire Pressure Position and Tire Pressure Telltale



When the tire pressure monitoring system warning indicators are illuminated and a warning message displayed on the cluster LCD display, one or more of your tires is significantly under-inflated. The Low Tire Pressure Position Telltale will indicate which tire is significantly underinflated by illuminating the corresponding position light.

If either telltale illuminates, immediately reduce your speed, avoid hard cornering and anticipate increased stopping distances. You should stop and check your tires as soon as possible. Inflate the tires to the proper pressure as indicated on the vehicle's placard or tire inflation pressure label located on the driver's side center pillar outer panel.

If you cannot reach a service station or if the tire cannot hold the newly added air, replace the low pressure tire with the spare tire.

The Low Tire Pressure Telltale will remain on and the TPMS Malfunction Indicator may blink for one minute and then remain illuminated (when the vehicle is driven approximately 10 minutes at speed above 15.5 mph (25 km/h)) until you have the low pressure tire repaired and replaced on the vehicle.



CAUTION

In winter or cold weather, the Low Tire Pressure Telltale may be illuminated if the tire pressure was adjusted to the recommended tire inflation pressure in warm weather. It does not mean your TPMS is malfunctioning because the decreased temperature leads to a proportional lowering of tire pressure.

When you drive your vehicle from a warm area to a cold area or from a cold area to a warm area, or the outside temperature is greatly higher or lower, you should check the tire inflation pressure and adjust the tires to the recommended tire inflation pressure.



WARNING

Low pressure damage

Significantly low tire pressure makes the vehicle unstable and can contribute to loss of vehicle control and increased braking distances.

Continued driving on low pressure tires can cause the tires to overheat and fail.



TPMS (Tire Pressure Monitoring System) Malfunction Indicator

The TPMS Malfunction Indicator will illuminate after it blinks for approximately one minute when there is a problem with the Tire Pressure Monitoring System.

Have the system checked by an authorized HYUNDAI dealer as soon as possible.

NOTICE

If there is a malfunction with the TPMS, the Low Tire Pressure Position Telltale will not be displayed even though the vehicle has an under-inflated tire.

NOTICE

The TPMS Malfunction Indicator may illuminate after blinking for one minute if the vehicle is near electric power supply cables or radio transmitters such as police stations, government and public offices, broadcasting stations, military installations, airports, transmitting towers, etc.

Additionally, the TPMS Malfunction Indicator may illuminate if snow chains are used or electronic devices such as computers, chargers, remote starters, navigation, etc. This may interfere with normal operation of the TPMS.

Changing a Tire with TPMS

If you have a flat tire, the Low Tire Pressure and Position telltales will come on. Have the flat tire repaired by an authorized HYUNDAI dealer as soon as possible or replace the flat tire with the spare tire.

NOTICE

It is recommended that you do not use a puncture-repairing agent not approved by an authorized HYUNDAI dealer or the equivalent specified for your vehicle to repair and/or inflate a low pressure tire. Tire sealant not approved by an authorized HYUNDAI dealer or the equivalent specified for your vehicle may damage the tire pressure sensor.

The spare tire (if equipped) does not come with a tire pressure monitoring sensor. When the low pressure tire or the flat tire is replaced with the spare tire, the Low Tire Pressure Telltale will remain on. Also, the TPMS Malfunction Indicator will illuminate after blinking for one minute if the vehicle is driven at speed above 15.5 mph (25 km/h) for approximately 10 minutes.

Once the original wheel equipped with a tire pressure monitoring sensor is reinflated to the recommended pressure and reinstalled on the vehicle, the Low Tire Pressure Telltale and TPMS Malfunction Indicator will go off within a few minutes of driving.

If the indicators do not extinguish after a few minutes, consult an authorized HYUNDAI dealer.

Each wheel is equipped with a tire pressure sensor mounted inside the tire behind the valve stem (except for the spare tire). You must use TPMS specific wheels. It is recommended that you always have your tires serviced by an authorized HYUNDAI dealer.

You may not be able to identify a tire with low pressure by simply looking at it. Always use a good quality tire pressure gauge to measure. Please note that a tire that is hot (from being driven) will have a higher pressure measurement than a tire that is cold.

A cold tire means the vehicle has been sitting for 3 hours and driven for less than 1 mile (1.6 km) in that 3 hour period.

Allow the tire to cool before measuring the inflation pressure. Always be sure the tire is cold before inflating to the recommended pressure.

WARNING

- The TPMS cannot alert you to severe and sudden tire damage caused by external factors such as nails or road debris.
- If you feel any vehicle instability, immediately take your foot off the accelerator, apply the brakes gradually with light force, and slowly move to a safe position off the road.

WARNING

Tampering with, modifying, or disabling the Tire Pressure Monitoring System (TPMS) components may interfere with the system's ability to warn the driver of low tire pressure conditions and/or TPMS malfunctions. Tampering with, modifying, or disabling the Tire Pressure Monitoring System (TPMS) components may void the warranty for that portion of the vehicle.

WARNING

This device complies with Part 15 of the FCC rules.

Operation is subject to the following three conditions:

1. This device may not cause harmful interference.
2. This device must accept any interference received, including interference that may cause undesired operation of the device.
3. Changes or modifications not expressly approved by the party responsible for compliance could void the user's authority to operate the device.

Information



ONE1081026

For 20 inches wheel, take out the remover tool (1) in the Tire Mobility Kit. Insert the tool to the hole and pull out the wheel cover.

IF YOU HAVE A FLAT TIRE (WITH TIRE MOBILITY KIT, IF EQUIPPED)



For safe operation, carefully read and follow the instructions in this manual before use.

- (1) Compressor
- (2) Sealant bottle

The tire mobility kit is a temporary fix to the tire, have the tire inspected by an authorized HYUNDAI dealer or the sealant provided with the Tire Mobility Kit must be used for only one flat tire.

CAUTION

When two or more tires are flat, do not use the tire mobility kit because the sealant provided with the Tire Mobility Kit must be used for only one flat tire.

WARNING

Do not use the Tire Mobility Kit to repair punctures in the tire walls. This can result in an accident due to tire failure.

WARNING

Have your tire repaired as soon as possible. The tire may lose air pressure at any time after inflating with the Tire Mobility Kit.

Introduction

With the Tire Mobility Kit you stay mobile even after experiencing a tire puncture.

The compressor and sealing compound system effectively and comfortably seals most punctures in a passenger car tire caused by nails or similar objects and reinflates the tire.

After you ensure that the tire is properly sealed you can drive cautiously on the tire (distance up to 120 miles (200 km)) at a max. speed of 50 mph (80 km/h) in order to reach a service station or tire dealer for the tire replacement.

It is possible that some tires, especially with larger punctures or damage to the sidewall, cannot be sealed completely.

Air pressure loss in the tire may adversely affect tire performance.

For this reason, you should avoid abrupt steering or other driving maneuvers, especially if the vehicle is heavily loaded or if a trailer is in use.

The Tire Mobility Kit is not designed or intended as a permanent tire repair method and is to be used for one tire only.

This instruction shows you step by step how to temporarily seal the puncture simply and reliably.

Read the section "Notes on the safe use of the Tire Mobility Kit".

WARNING

Do not use the TMK if a tire is severely damaged by driving run flat or with insufficient air pressure.

Only punctured areas located within the tread region of the tire can be sealed using the TMK.

Notes on the Safe Use of the Tire Mobility Kit

- Park your car at the side of the road so that you can work with the Tire Mobility Kit away from moving traffic.
- To be sure your vehicle will not move, even when you're on fairly level ground, always set your parking brake.
- Only use the Tire Mobility Kit for sealing/inflation passenger car tires. Only punctured areas located within the tread region of the tire can be sealed using the tire mobility kit.
- Do not use on motorcycles, bicycles or any other type of tires.
- When the tire and wheel are damaged, do not use Tire Mobility Kit for your safety.
- Use of the Tire Mobility Kit may not be effective for tire damage larger than approximately 0.24 in (6 mm).
- If the tire cannot be made roadworthy with the Tire Mobility Kit, contact an authorized HYUNDAI dealer.
- Do not use the Tire Mobility Kit if a tire is severely damaged by driving run flat or with insufficient air pressure.
- Do not remove any foreign objects such as nails or screws that have penetrated the tire.
- Provided the car is outdoors, leave the Vehicle is ON (READY indicator ON). Otherwise operating the compressor may eventually drain the car battery.
- Never leave the Tire Mobility Kit unattended while it is being used.
- Do not leave the compressor running for more than 10 min. at a time or it may overheat.
- Do not use the Tire Mobility Kit if the ambient temperature is below -22°F (-30°C).
- In case of skin contact with the sealant, wash the area thoroughly with plenty of water. If the irritation persists, seek medical attention.
- In case of eye contact with the sealant, flush your eyes for at least 15 minutes. If the irritation persists, seek medical attention.
- In case of swallowing the sealant, rinse the mouth and drink plenty of water. However, never give anything to an unconscious person and seek medical attention immediately.
- Long time exposure to the sealant may cause damage to bodily tissue such as kidney, etc.

Components of the Tire Mobility Kit

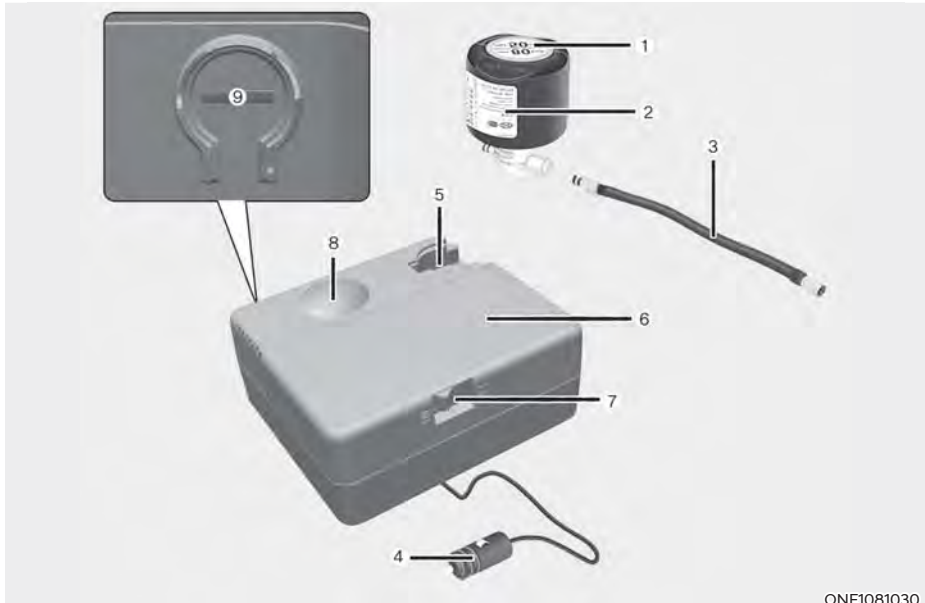

ONE1081030

1. Speed-restriction label
2. Sealant bottle and label with speed restriction
3. Filling hose
4. Connectors and cable for the power outlet direct connection
5. Holder for the sealant bottle
6. Compressor
7. ON/OFF switch
8. Pressure gauge for displaying the tire inflation pressure
9. Button for reducing the tire inflation pressure

Connectors, cable and connection hose are stored in the compressor housing. Strictly follow the specified sequence, otherwise the sealant may escape under high pressure.

WARNING

Expired sealant

Do not use the Tire sealant after the sealant has expired (for example, the expiration date on the sealant container). This can increase the risk of tire failure.

WARNING

Sealant

- Keep out of reach of children.
- Avoid contact with eyes.
- Do not swallow.

Using the Tire Mobility Kit When a Tire is Flat

CAUTION



Detach the speed restriction label (1) from the sealant bottle (2), and place it in a highly visible place inside the vehicle such as on the steering wheel to remind the driver not to drive too fast.

CAUTION

If only the tire pressure needs to be adjusted, refer to “How to Adjust Tire Pressure” in this chapter.

Before using the Tire Mobility Kit, be fully aware of the explanation on the sealant.

1. Shake the sealant bottle (2).



2. Connect the filling hose (3) to the sealant bottle (2) in the direction of (A) and connect the sealant bottle to the compressor (6) in the direction of (B).
3. Ensure that the compressor is switched OFF.
4. Unscrew the valve cap from the valve of the defective wheel and screw the filling hose (3) of the sealant bottle onto the valve.



CAUTION

Securely install the sealant filling hose to the valve. If not, sealant may flow backward, possibly clogging the filling hose.



5. Plug the compressor power cord (4) into the vehicle power outlet.

NOTICE

Only use the front passenger side power outlet when connecting the power cord.

6. With the vehicle ON (**READY** indicator ON), switch on the compressor and let it run for approximately 5–7 minutes to fill the sealant up to proper pressure. (refer to the Tire and Wheels, chapter 2). The inflation pressure of the tire after filling is unimportant and will be checked/corrected later.

Be careful not to overinflate the tire and stay away from the tire when filling it.



CAUTION

Tire pressure

Do not attempt to drive your vehicle if the tire pressure is below 200 kPa (29 psi). This could result in an accident due to sudden tire failure.

7. Switch off the compressor.
8. Detach the hoses from the sealant bottle connector and from the tire valve.

Return the Tire Mobility Kit to its storage location in the vehicle.

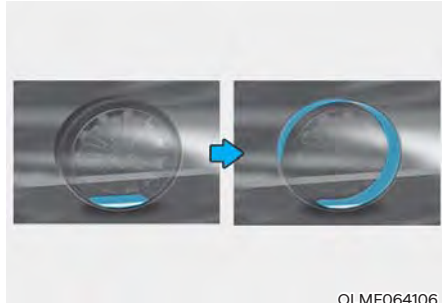

9. Immediately drive approximately 4–6 miles (7–10 km or, about 10min) to evenly distribute the sealant in the tire.

Do not exceed a speed of 50 mph (80 km/h). If possible, do not fall below a speed of 12 mph (20 km/h).

While driving, if you experience any unusual vibration, ride disturbance or noise, reduce your speed and drive with caution until you can safely pull off of the side of the road.

Call for road side service or towing.

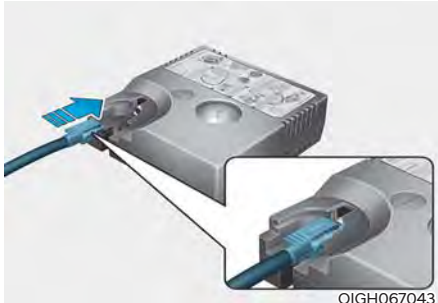

OIGH067043



ONE1081009

10. After driving approximately 4~6 miles (7~10 km or about 10 min), stop at a safety location.
11. Connect the filling hose (3) of the compressor directly to the tire valve.
12. Plug the compressor power cord into the vehicle power outlet.
13. Adjust the tire inflation pressure to the recommended tire inflation.

With the Vehicle is ON (READY indicator ON) proceed as follows.

- To increase the inflation pressure : Switch on the compressor. To check the current inflation pressure setting, briefly switch off the compressor.
- To reduce the inflation pressure: Press the button (9) on the compressor.
-

NOTICE

Do not let the compressor run for more than 10 minutes, otherwise the device will overheat and may be damaged.

i Information

The pressure gauge may show higher than actual reading when the compressor is running. To get an accurate tire reading, the compressor needs to be turned off.

⚠ CAUTION

If the inflation pressure is not maintained, drive the vehicle a second time, refer to step 9.

Then repeat steps 10 to 13.

Use of the TMK may be ineffectual for tire damage larger than approximately 0.16 in (4 mm).

Contact an authorized HYUNDAI dealer if the tire cannot be made roadworthy with the Tire Mobility Kit.

⚠ WARNING

The tire inflation pressure must be at least 32 psi (220 kPa). If it is not, do not continue driving.

Call for road side service or towing.

⚠ CAUTION

Tire pressure sensor (if equipped with TPMS)

The sealant on the tire pressure sensor and wheel should be removed when you replace the tire with a new one and inspect the tire pressure sensors. We recommend that you get this done at an authorized HYUNDAI dealer.

i Information

When reinstalling the repaired or replaced tire and wheel on the vehicle, tighten the wheel lug nut to 79~94 lbf·ft (11~13 kgf·m).

How to Adjust Tire Pressure

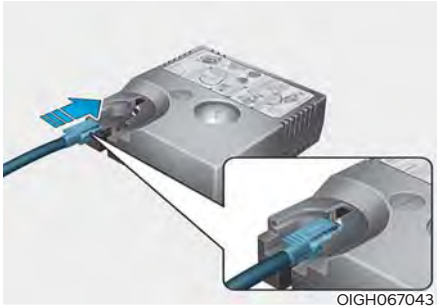

1. Park your vehicle in a safe location.
2. Connect the filling hose (3) of the compressor directly to the tire valve.
3. Plug the compressor power cord into the vehicle power outlet.

4. Adjust the tire inflation pressure to the recommended tire inflation.

With the Vehicle is ON (READY indicator ON), proceed as follows.

- To increase the inflation pressure : Switch on the compressor. To check the current inflation pressure setting, briefly switch off the compressor.
- To reduce the inflation pressure: Press the button (9) on the compressor.

NOTICE

Do not let the compressor run for more than 10 minutes, otherwise the device will overheat and may be damaged.

i Information

- The pressure gauge may show higher than actual reading when the compressor is running. To get an accurate tire reading, the compressor needs to be turned off.
- When reinstalling the repaired or replaced tire and wheel on the vehicle, tighten the wheel lug nut to 79~94 lbf·ft (11~13kgf·m).

CAUTION

Do not use the sealant when the tire pressure only needs to be adjusted.

WARNING

The tire inflation pressure must be at least 220 kPa (32 psi). If it is not, do not continue driving.

Call for road side service or towing.

TOWING

Towing Service

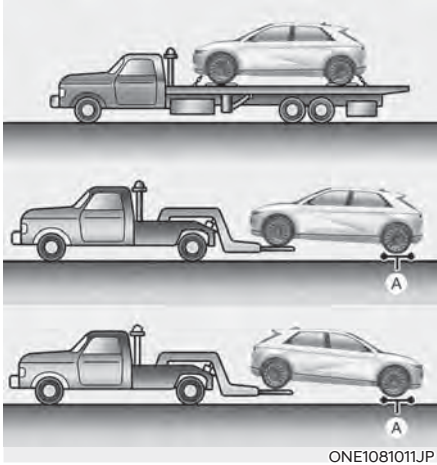

ONE1081011JP

[A] : Dollies

If emergency towing is necessary, have it done by an authorized HYUNDAI dealer or a commercial tow-truck service.

Proper lifting and towing procedures are necessary to prevent damage to the vehicle. The use of wheel dollies or flatbed is recommended.

For 2WD vehicles, it is acceptable to tow the vehicle with the front wheels on the ground (without dollies) and the rear wheels off the ground.

If any of the loaded wheels or suspension components are damaged or the vehicle is being towed with the rear wheels on the ground, use a towing dolly under the rear wheels.

When being towed by a commercial tow truck and wheel dollies are not used, the rear of the vehicle should always be lifted, not the front.

For AWD vehicles, it must be towed with a wheel lift and dollies or flatbed equipment with all the wheels off the ground.

Precautions when moving a short distance before towing a vehicle

Move short distances within 394 in. (10 m) at a speed of 3 mph (5 km/h) or less only when loading on a tow truck or if the vehicle needs to be repositioned.

At this time, the gear must be in the 'N' (neutral) position and the parking brake must be released. If it is impossible to operate the transmission and parking brake, move the vehicle with the rear wheel lifted.

NOTICE

Do not lift the vehicle by the tow fitting or body and chassis parts. Otherwise the vehicle may be damaged.



CAUTION

- **Do not tow the vehicle with the rear wheels on the ground as this may cause damage to the vehicle.**



- **Do not tow with sling-type equipment. Use wheel lift or flatbed equipment.**

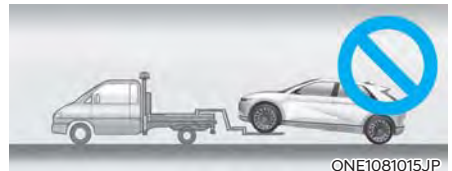

When towing your vehicle in an emergency without wheel dollies:

1. While depressing the brake pedal shift to the N (Neutral) position and turn the vehicle off. The START/STOP button will be in the ACC position.
2. Release the parking brake.

 **CAUTION**

Failure to shift the gear to N (Neutral) may cause internal damage to the reduction gear.

Removable Towing Hook

1. Open the liftgate, and remove the towing hook from the tool case.
2. Remove the hole cover.

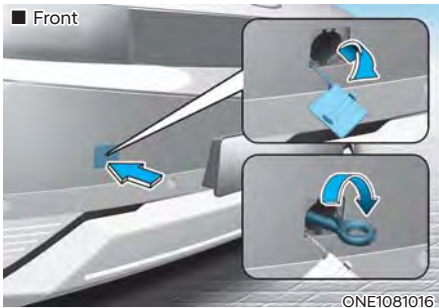

- Push the lower part of the bumper hole cover.

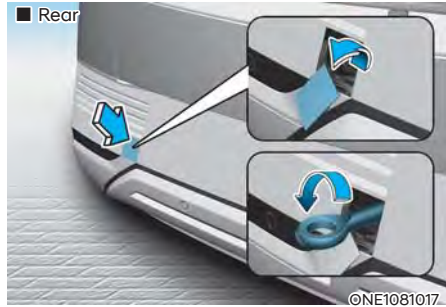

- Push the upper part of the bumper hole cover.
 - Pull the lower part of the bumper hole cover.
3. Install the towing hook by turning it clockwise into the hole until it is fully secured.
 4. Remove the towing hook and install the cover after use.

NOTICE

Failure to properly tighten the towing hook may result in vehicle damage and deformation of related parts.

 **CAUTION**

Make sure the towing hook is tightened properly. If not, during towing the towing hook may be thrown off the vehicle resulting in serious injury or accident.

9. Maintenance

Motor Compartment	9-3
Maintenance Services	9-4
Owner's Responsibility	9-4
Owner Maintenance Precautions.....	9-4
Owner Maintenance	9-5
Owner Maintenance Schedule.....	9-6
Scheduled Maintenance Services	9-7
Normal Maintenance Schedule	9-8
Maintenance Under Severe Usage and Low Mileage Conditions.....	9-10
Explanation of Scheduled Maintenance Items.....	9-11
Coolant	9-12
Brake Fluid.....	9-13
Checking the Brake Fluid Level.....	9-13
Reduction Gear Fluid.....	9-14
Washer Fluid.....	9-14
Checking the Washer Fluid Level.....	9-14
Cabin Air Filter.....	9-15
Filter Inspection.....	9-15
Filter Replacement.....	9-15
Wiper Blades	9-16
Blade Inspection	9-16
Blade Replacement.....	9-16
Battery (12 volt)	9-19
For Best Battery Service	9-20
Battery Capacity Label.....	9-20
Battery Recharging	9-20
Reset Items.....	9-21

Tires and Wheels.....	9-22
Tire Care.....	9-22
Recommended Cold Tire Inflation Pressures.....	9-22
Check Tire Inflation Pressure.....	9-23
Tire Rotation	9-24
Wheel Alignment and Tire Balance.....	9-25
Tire Replacement	9-25
Wheel Replacement.....	9-26
Tire Traction	9-26
Tire Maintenance.....	9-26
Tire Sidewall Labeling	9-26
Tire Terminology and Definitions	9-29
All Season Tires.....	9-33
Summer Tires	9-33
Snow Tires.....	9-33
Radial-Ply Tires.....	9-33
Low Aspect Ratio Tires.....	9-34
Fuses.....	9-35
Instrument Panel Fuse Replacement.....	9-36
Motor Compartment Panel Fuse Replacement	9-37
Fuse/Relay Panel Description.....	9-38
Light Bulbs.....	9-48
Headlight, Parking Lamp, Turn Signal Lamp, Daytime Running Light (DRL) Replacement	9-49
Side Repeater Lamp Replacement	9-51
Rear Combination Lamp Replacement	9-51
High Mounted Stop Lamp Replacement.....	9-53
License Plate Lamp Replacement.....	9-53
Front Trunk Lamp Replacement.....	9-54
Interior Light Replacement.....	9-54
Appearance Care	9-56
Exterior Care.....	9-56
Interior Care.....	9-61
California Perchlorate Notice.....	9-64

MOTOR COMPARTMENT

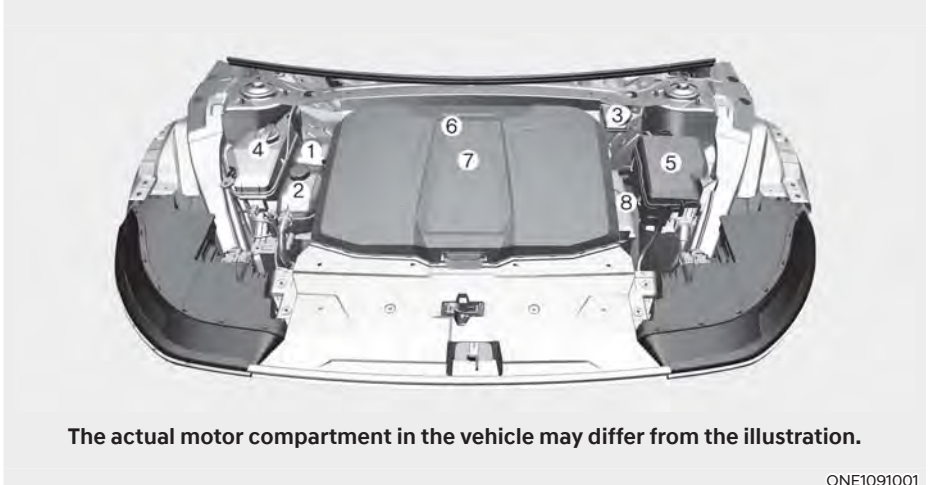

The actual motor compartment in the vehicle may differ from the illustration.

ONE1091001

1. Coolant reservoir
2. Low Conductivity Coolant
3. Brake fluid reservoir
4. Windshield washer fluid reservoir
5. Fuse box
6. Climate control system air filter
7. Front trunk
8. Battery (12V)

MAINTENANCE SERVICES

You should exercise the utmost care to prevent damage to your vehicle and injury to yourself whenever performing any maintenance or inspection procedures.

Have your vehicle maintained and repaired by an authorized HYUNDAI dealer. An authorized HYUNDAI dealer meets HYUNDAI's high service quality standards and receives technical support from HYUNDAI in order to provide you with a high level of service satisfaction.

Owner's Responsibility

Maintenance service and record retention are the owner's responsibility.

You should retain documents that show proper maintenance has been performed on your vehicle in accordance with the scheduled maintenance service charts shown on the following pages. You need this information to establish your compliance with the servicing and maintenance requirements of your vehicle warranties.

Detailed warranty information is provided in your Owner's Handbook & Warranty Information booklet.

Repairs and adjustments required as a result of improper maintenance or a lack of required maintenance are not covered.

Owner Maintenance Precautions

Inadequate, incomplete or insufficient servicing may result in operational problems with your vehicle that could lead to vehicle damage, an accident, or personal injury. This chapter provides instructions only for the maintenance items that are easy to perform.

Your vehicle should not be modified in any way. Such modifications may adversely affect the performance, safety or durability of your vehicle and may, in addition, violate conditions of the limited warranties covering the vehicle.

Certain modifications may also be in violation of regulations established by the U.S. Department of Transportation and other federal or state agencies.

NOTICE

Improper owner maintenance during the warranty period may affect warranty coverage. For details, read the separate Owner's Handbook & Warranty Information booklet provided with the vehicle. If you're unsure about any service or maintenance procedure, have it done by an authorized HYUNDAI dealer.

OWNER MAINTENANCE



WARNING

Performing maintenance work on a vehicle can be dangerous. If you lack sufficient knowledge and experience or the proper tools and equipment to do the work, we recommend that it is done by an authorized HYUNDAI dealer. ALWAYS follow these precautions for performing maintenance work:

- **Park your vehicle on level ground. Shift the vehicle to P (Park), apply the parking brake, and press the Start/Stop button to the OFF position.**
- **Block the tires (front and back) to prevent the vehicle from moving. Remove loose clothing or jewelry that can become entangled in moving parts.**
- **Keep flames, sparks, or smoking materials away from the battery and motor related parts.**



WARNING

Make sure to turn the START/STOP button to the 'OFF' position to shut down the vehicle before performing maintenance work on the vehicle.

The following lists are vehicle checks and inspections that should be performed by the owner or an authorized HYUNDAI dealer at the frequencies indicated to help ensure safe, dependable operation of your vehicle.

Any adverse conditions should be brought to the attention of your dealer as soon as possible.

These Owner Maintenance vehicle checks are generally not covered by warranties and you may be charged for labor, parts and lubricants used.

The electric control system in the vehicle may cause malfunction or other negative impact on the artificial heart and the artificial internal organs. Be sure to inquire the impact of the electric control system on the artificial organs from the medical product corporation.

Owner Maintenance Schedule

When you stop for charging:

- Check the coolant level in the coolant reservoir.
- Check the windshield washer fluid level.
- Check for low or under-inflated tires.



WARNING

Be careful when checking your coolant level if the motor compartment is hot. This may result in coolant being blown out of the opening and cause serious burns and other injuries.

While operating your vehicle:

- Check for vibrations in the steering wheel. Notice if there is any increased steering effort or looseness in the steering wheel, or change in its straight-ahead position.
- Notice if your vehicle constantly turns slightly or “pulls” to one side when traveling on smooth, level road.
- When stopping, listen and check for unusual sounds, pulling to one side, increased brake pedal travel or “hard-to-push” brake pedal.
- If any slipping or changes in the operation of your gear shift occurs, check the shift gear fluid level.
- Check the shift gear P (Park) function.
- Check the parking brake.
- Check for fluid leaks under your vehicle (water dripping from the air conditioning system during or after use is normal).

At least monthly:

- Check coolant level in the coolant reservoir.
- Check the operation of all exterior lights, including the stoplights, turn signals and hazard warning flashers.
- Check the inflation pressures of all tires including the spare for tires that are worn, show uneven wear, or are damaged.
- Check for loose wheel lug nuts.

At least twice a year: (for example, every Spring and Autumn)

- Check radiator, heater and air conditioning hoses for leaks or damage.
- Check windshield washer spray and wiper operation. Clean wiper blades with a clean cloth dampened with washer fluid.
- Check headlight alignment.
- Check the seat belts for wear and function.

At least once a year:

- Clean body and door drain holes.
- Lubricate door hinges and hood hinges.
- Lubricate door and hood locks and latches.
- Lubricate door rubber weather strips.
- Check the air conditioning system.
- Inspect and lubricate shift gear linkage and controls.
- Clean the battery (12V) and terminals.
- Check the brake fluid level.

SCHEDULED MAINTENANCE SERVICES

Follow Normal Maintenance Schedule if the vehicle is usually operated where none of the following conditions apply. If any of the following conditions apply, you must follow the Maintenance Under Severe Usage Conditions.

- Repeated driving short distance of less than 5 miles (8 km) in normal temperature or less than 10 miles (16 km) in freezing temperature
- Driving on rough, dusty, muddy, unpaved, graveled or salt-spread roads
- Driving in areas using salt or other corrosive materials or in very cold weather
- Driving in heavy dust condition
- Driving in heavy traffic area with the ambient temperature higher than 90 °F (32 °C) while consuming more than 50% of electric energy.
- Driving on uphill, downhill, or mountain roads repeatedly
- Towing a trailer, or using a camper or roof rack
- Driving as a patrol car, taxi, other commercial use or vehicle towing
- Frequently driving under high speed or rapid acceleration/deceleration
- Frequently driving in stop-and-go conditions

If your vehicle is operated under the above conditions, you should inspect, replace or refill more frequently than the following Normal Maintenance Schedule. After the periods or distance shown in the chart, continue to follow the prescribed maintenance intervals.



Information

After driving more than 10 years or 100,000 miles, use severe maintenance schedule.

Normal Maintenance Schedule

The following maintenance services must be performed to ensure good vehicle performance. Keep receipts for all vehicle services to protect your warranty. Where both mileage and time are shown, the frequency of service is determined by whichever occurs first.

MAINTENANCE ITEM	MAINTENANCE INTERVALS													
	Months	12	24	36	48	60	72	84	96	108	120	132	144	156
	Miles×1,000	8	16	24	32	40	48	56	64	72	80	88	96	104
	Km×1,000	13	26	39	52	65	78	91	104	117	130	143	156	169
Cooling system														
12V auxiliary battery condition														
Brake lines, hoses, and connections														
Disc brakes and pads	I	I	I	I	I	I	I	I	I	I	I	I	I	I
Brake pedal														
Steering gear rack, linkage, and boots														
Air conditioning compressor, air conditioner refrigerant and performance														

I : Inspect and if necessary, adjust, correct, clean or replace.
 R : Replace or change.

Normal Maintenance Schedule

MAINTENANCE ITEM	MAINTENANCE INTERVALS																
	Months	12	24	36	48	60	72	84	96	108	120	132	144	156			
Drive shafts and boots			I	I	I	I	I	I	I	I	I	I	I	I			
Replace Climate Control Air Filter (For Evaporator and Blower Unit)	I		R	I	R	I	R	I	R	I	R	I	R	I			
Reduction gear fluid					I				I				I				
Rotate Tires (Includes Tire Pressure and Tread Wear Inspection)		Rotate every 8,000 miles (13,000 km) or 12 months															
Coolant *1	Standard		At first, replace 120,000 miles (200,000 km) or 120 months. After that, replace every 24,000 miles (40,000 km) or 24 months.														
	Low Conductivity		Replace every 35,000 miles (60,000 km) or 36 months *2														
Brake fluid		Inspect every 8,000 miles (13,000 km) or 12 months, Replace every 48,000 miles (78,000 km) or 48 months															

I : Inspect and if necessary, adjust, correct, clean or replace.

R : Replace or change.

*1: Consult an authorized HYUNDAI dealer, when replacing or adding coolant.

*2: For your convenience, it can be replaced prior to it's interval when you do maintenance of other items.

Maintenance Under Severe Usage and Low Mileage Conditions

The following items must be serviced more frequently on cars mainly used under severe driving conditions.

Refer to the chart below for the appropriate maintenance intervals.

R : Replace I : Inspect and if necessary, adjust, correct, clean or replace

Maintenance item	Maintenance operation	Maintenance intervals	Driving condition
Reduction gear fluid	R	Every 80,000 miles (120,000 km)	A, B, E, F, H, J
Steering gear rack, linkage and boots	I	Inspect more frequently depending on the condition	B, C, D, E, F
Front suspension ball joints	I	Inspect more frequently depending on the condition	B, C, D, E, F
Disc brakes and pads, calipers and rotors	I	Inspect more frequently depending on the condition	B, C, D, E, F, G, H, I, J
Driveshaft and boots	I	Inspect more frequently depending on the condition	B, C, D, E, F, G, H, I
Climate control air filter	R	Replace more frequently depending on the condition	B, D, F

Severe driving conditions

- A. Repeatedly driving short distance of less than 5 miles (8 km) in normal temperature or less than 10 miles (16 km) in freezing temperature
- B. Driving on rough, dusty, muddy, unpaved, graveled or salt spread roads
- C. Driving in areas using salt or other corrosive materials or in very cold weather
- D. Driving in heavy dust condition
- E. Driving in heavy traffic area with the ambient temperature higher than 90 °F (32 °C) while consuming more than 50% of electric energy.
- F. Driving on uphill, downhill, or mountain roads repeatedly
- G. Towing a trailer, or using a camper or roof rack
- H. Driving as a patrol car, taxi, other commercial use or vehicle towing
- I. Frequently driving under high speed or rapid acceleration/deceleration
- J. Frequently driving in stop-and-go conditions

EXPLANATION OF SCHEDULED MAINTENANCE ITEMS

Cooling System

Check cooling system components, such as radiator, coolant reservoir, hoses and connections for leakage and damage. Replace any damaged parts.

Coolant

The coolant should be changed at the intervals specified in the maintenance schedule.

Reduction Gear Fluid

The reduction gear fluid should be inspected according to the intervals specified in the maintenance schedule.

Brake Hoses and Lines

Visually check for proper installation, chafing, cracks, deterioration and any leakage. Replace any deteriorated or damaged parts immediately.

Brake Fluid

Check the brake fluid level in the brake fluid reservoir. The level should be between the MIN and the MAX marks on the side of the reservoir. Use only hydraulic brake fluid conforming to DOT 4 specification.

Brake Discs, Pads, Calipers and Rotors

Check the pads, the discs, and the rotors for any excessive wear-out. Inspect calipers for any fluid leakage.

Suspension Mounting Bolts

Check the suspension connections for looseness or damage. Retighten to the specified torque.

Steering Gear Box, Linkage & Boots/Lower Arm Ball Joint

With the vehicle stopped and the vehicle off, check for excessive free-play in the steering wheel. Check the linkage for bends or damage. Check the dust boots and ball joints for deterioration, cracks, or damage.

Replace any damaged parts.

Drive Shafts and Boots

Check the drive shafts, boots and clamps for cracks, deterioration, or damage. Replace any damaged parts and, if necessary, repack the grease.

Air Conditioning Refrigerant

Check the air conditioning lines and connections for leakage and damage.

COOLANT

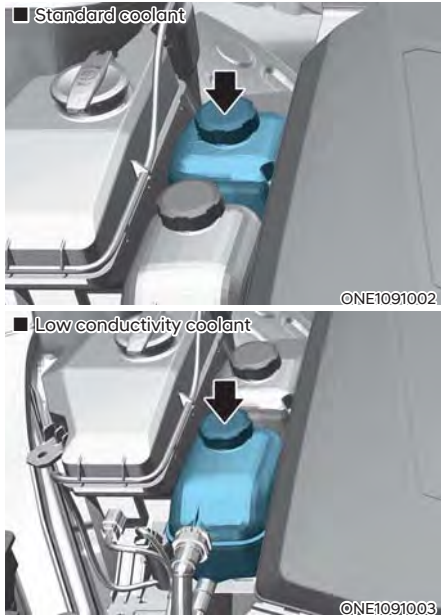

Check the condition and connections of all cooling system hoses and heater hoses. Replace any swollen or deteriorated hoses.

The coolant level should be filled between the MAX or F and the MIN or L marks on the side of the coolant reservoir when the parts in the motor compartment is cool.

If the coolant is low, have the vehicle inspected by an authorized HYUNDAI dealer.

Use only designated coolant water for electric vehicles, adding other types of water or antifreeze can damage the vehicle.

WARNING

Since specific coolant water (Blue color, Low conductivity) is applied for electric vehicles, replenishment of other antifreeze or water may cause problems to the vehicle.

WARNING



The electric motor for the cooling fan may continue to operate or start up when the vehicle is not running and can cause serious injury.



Keep hands, clothing and tools away from the rotating fan blades of the cooling fan.

The electric motor for the cooling fan is controlled by vehicle coolant temperature, refrigerant pressure and vehicle speed. As the vehicle coolant temperature decreases, the electric motor will automatically shut off. This is a normal condition.

BRAKE FLUID

Checking the Brake Fluid Level



Check the fluid level in the reservoir periodically. The fluid level should be between MAX and MIN marks on the side of the reservoir.

Before removing the reservoir cap and adding brake fluid, clean the area around the reservoir cap thoroughly to prevent brake fluid contamination.

If the level is low, add the specified brake fluid to the MAX level. The level will fall with accumulated kilometers. This is a normal condition associated with the wear of the brake linings. If the fluid level is excessively low, have the brake system checked by an authorized HYUNDAI dealer.



WARNING

If the brake system requires frequent additions of fluid this could indicate a leak in the brake system. Have the vehicle inspected by an authorized HYUNDAI dealer.



WARNING

Do not let brake fluid enter into your eyes. If brake fluid gets in your eyes, flush your eyes with clean water for at least 15 minutes and get immediate medical attention.

NOTICE

- Do not allow brake fluid to contact the vehicle's body paint, as it will result in paint damage.
- NEVER use brake fluid which has been exposed to open air for an extended time, as its quality cannot be guaranteed. It should be disposed of properly.
- Do not use the wrong type of brake fluid. A few drops of mineral based oil in your brake system can damage brake system parts.



Information

Use only the specified brake fluid (refer to “Recommended Lubricants and Capacities” section in chapter 2).

REDUCTION GEAR FLUID

There is no reduction gear fluid level gauge in the vehicle. Check the reduction gear fluid every 56,000 km regularly. If the vehicle is driven under severe condition, check the maintenance under severe usage condition and consult an authorized HYUNDAI dealer.

WASHER FLUID

Checking the Washer Fluid Level

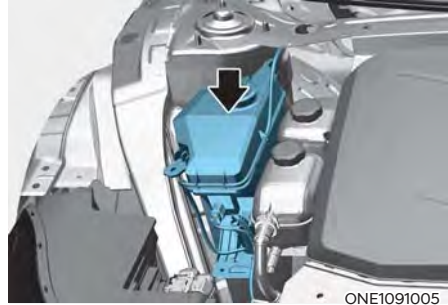

Check the fluid level in the washer fluid reservoir and add fluid if necessary. Plain water may be used if washer fluid is not available. However, use washer solvent with antifreeze characteristics in cold climates to prevent freezing.



WARNING

To prevent serious injury or death, take the following safety precautions when using washer fluid:

- Do not use coolant or antifreeze in the washer fluid reservoir. Coolant can severely obscure visibility when sprayed on the windshield and may cause loss of vehicle control resulting in an accident or damage to paint and body trim.
- Do not allow sparks or flame to contact the washer fluid or the washer fluid reservoir. Washer fluid may contain alcohol and can be flammable.
- Do not drink washer fluid and avoid contact with skin. Washer fluid is harmful to humans and animals.
- Keep washer fluid away from children and animals.

CABIN AIR FILTER

Filter Inspection

The cabin air filter should be replaced according to the Maintenance Schedule. If the vehicle is operated in severely air-polluted cities or on dusty rough roads for a long period, it should be inspected more frequently and replaced sooner. Replace the cabin air filter by following the procedure below and be careful to avoid damaging other components.

Filter Replacement

1. Open the hood.



2. Lift up the front trunk cover while depressing the front trunk lever (1).

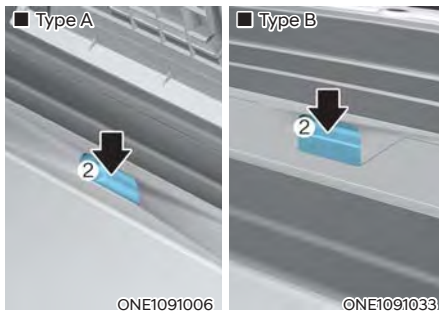

3. Remove the cover by pulling the front trunk handle (2).

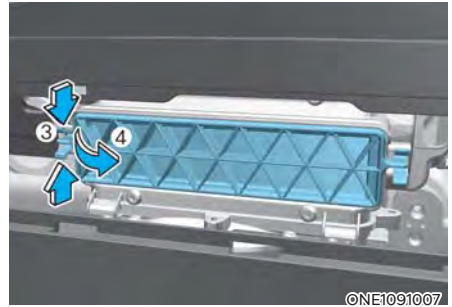

4. Press and hold the lock (3) on the left side of the cover (4).
5. Replace the cabin air filter.
6. Reassemble in the reverse order of disassembly.

NOTICE

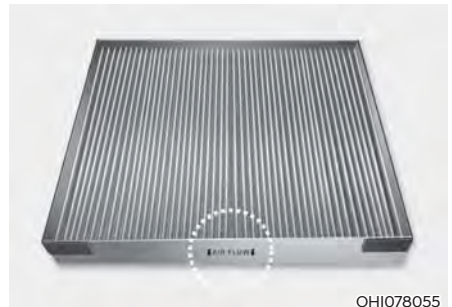

- Install a new cabin air filter in the correct direction with the arrow symbol (↘) facing downwards, to prevent noise and reduce effectiveness.
- Always be sure that the front trunk cover is firmly closed after replacing the cabin air filter. Otherwise it may cause interior damage in the motor compartment, noise trouble, or entrance of foreign substances.

WIPER BLADES

Blade Inspection

Contamination of either the windshield or the wiper blades with foreign matter can reduce the effectiveness of the windshield wipers.

Common sources of contamination are insects, tree sap, and hot wax treatments used by some commercial car washes. If the blades are not wiping properly, clean both the window and the blades with a good cleaner or mild detergent, and rinse thoroughly with clean water.

NOTICE

To prevent damage to the wiper blades, arms or other components, do not:

- Use gasoline, kerosene, paint thinner, or other solvents on or near them.
- Attempt to move the wipers manually.
- Use non-specified wiper blades.

i Information

Commercial hot waxes applied by automatic car washes have been known to make the windshield difficult to clean.

i Information

Wiper blades are consumable items. Normal wear of the wipers may not be covered by your vehicle warranty.

Blade Replacement

When the wipers no longer clean adequately, the blades may be worn or cracked, and require replacement.

NOTICE

- In order to prevent damage to the hood and the wiper arms, the wiper arms should only be lifted when in the top wiping position.
- Always return the wiper arms to the windshield before driving.

Front windshield wiper blade replacement

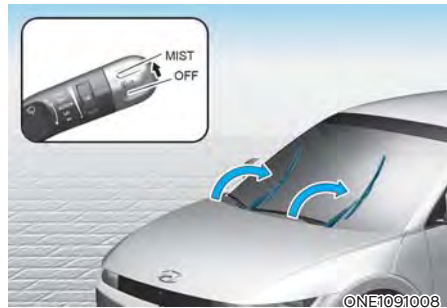

Within 20 seconds of turning off the vehicle, lift up and hold the wiper lever to the MIST position for about 2 seconds until the wipers move to the top wipe position.

At this time you can lift the wipers off the windshield.

Type A

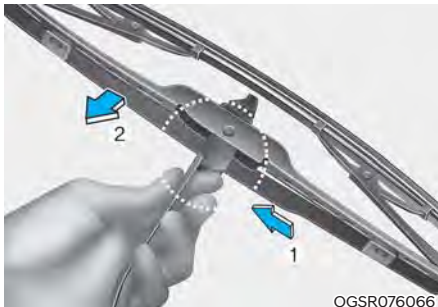

1. Lift up the wiper blade clip. Then lift up the wiper blade.
2. While pushing the lock (1), pull down the wiper blade (2).

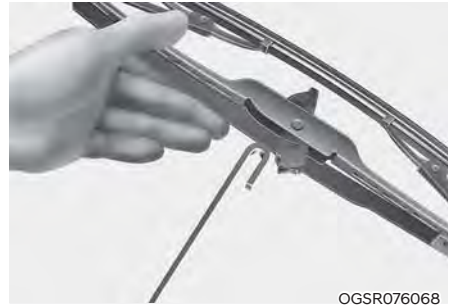

3. Remove the wiper blade from the wiper arm.
4. Install a new wiper blade assembly in the reverse order of removal.
5. Return the wiper arm on the windshield.

Type B

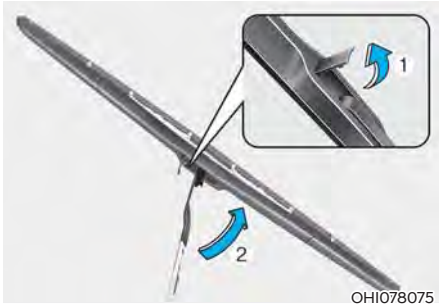

OHI078075

1. Lift up the wiper blade clip (1). Then lift up the wiper blade.



OHI078076

2. Press the clip (3). Then push the blade forward through the wiper arm to disassemble it (4).



OHI078077

3. Remove the wiper blade from the wiper arm (5).
4. Install the new blade assembly in the reverse order of removal.
5. Return the wiper arm on the windshield.

BATTERY (12 VOLT)



WARNING

To prevent **SERIOUS INJURY** or **DEATH** to you or bystanders, always follow these precautions when working near or handling the battery:



Always read and follow instructions carefully when handling a battery.



Wear eye protection designed to protect the eyes from acid splashes.



Keep all flames, sparks, or smoking materials away from the battery.



Hydrogen is always present in battery cells, is highly combustible, and may explode if ignited.



Keep batteries out of reach of children.



Batteries contain sulfuric acid which is highly corrosive. Do not allow acid to contact your eyes, skin or clothing. If acid gets into your eyes, flush your eyes with clean water for at least 15 minutes and get immediate medical attention. If acid gets on your skin, thoroughly wash the area. If you feel pain or a burning sensation, get medical attention immediately.

- When lifting a plastic-cased battery, excessive pressure on the case may cause battery acid to leak. Lift with a battery carrier or with your hands on opposite corners.
- Do not attempt to jump start your vehicle if your battery is frozen.

- **NEVER** attempt to recharge the battery when the vehicle's battery cables are connected to the battery.
- The electrical ignition switch works with high voltage. **NEVER** touch these components with the "READY" indicator ON or when the START/STOP button is in the ON position.



WARNING

CALIFORNIA PROPOSITION 65 WARNING

Battery posts, terminals, and related accessories contain lead and lead compounds, chemicals known to the State of California to cause cancer, birth defects and reproductive harm. Batteries also contain other chemicals known to the State of California to cause cancer. Wash hands after handling.

NOTICE

Always follow these instructions when handling your vehicle's battery to prevent damage to your battery:

- When you do not use the vehicle for a long time in a low temperature area, disconnect the battery and keep it indoors.
- Always charge the battery fully to prevent battery case damage in low temperature areas.
- Prevent liquid from wetting the battery terminals. The performance of the battery may be degraded, and may cause injury. Be cautious when loading liquid in the trunk.
- Do not tilt the battery.
- If you connect unauthorized electronic devices to the battery, the battery may be discharged. Never use unauthorized devices.

For Best Battery Service

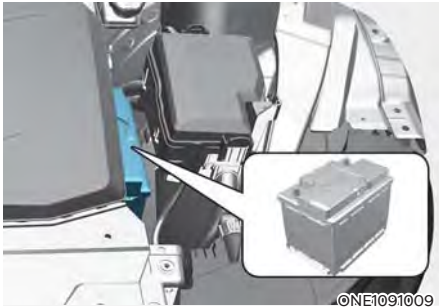

- Keep the battery securely mounted.
- Keep the battery top clean and dry.
- Keep the terminals and connections clean, tight, and coated with petroleum jelly or terminal grease.
- Rinse any spilled electrolyte from the battery immediately with a solution of water and baking soda.
- If the vehicle is not going to be used for an extended time, disconnect the battery cables.

Battery Capacity Label



* The actual battery label in the vehicle may differ from the illustration.

1. CMF60L-BCI : The HYUNDAI model name of battery
2. 12V : The nominal voltage
3. 60Ah(20HR) : The nominal capacity (in Ampere hours)
4. 92RC : The nominal reserve capacity (in min.)
5. 550CCA : The cold-test current in amperes by SAE
6. 440A : The cold-test current in amperes by EN

Battery Recharging

By battery charger

Your vehicle has a maintenance-free, calcium-based battery.

- If the battery becomes discharged over a short time (because, for example, the headlights or interior lights were left on while the vehicle was not in use), recharge it by slow charging (trickle) for 10 hours.
- If the battery gradually discharges because of high electrical load while the vehicle is being used, recharge it at 20-30A for two hours.



WARNING

Always follow these instructions when recharging your vehicle's battery to avoid the risk of **SERIOUS INJURY** or **DEATH** from explosions or acid burns:

- Before performing maintenance or recharging the battery, turn off all accessories and stop the vehicle.
- Keep all flames, sparks, or smoking materials away from the battery.
- Always work outdoors or in an area with plenty of ventilation.
- Wear eye protection when checking the battery during charging.
- The battery must be removed from the vehicle and placed in a well ventilated area.
- Watch the battery during charging, and stop or reduce the charging rate if the battery cells begin boiling violently.
- The negative battery cable must be removed first and installed last when the battery is disconnected. Disconnect the battery charger in the following order:
 1. Turn off the battery charger main switch.
 2. Unhook the negative clamp from the negative battery terminal.
 3. Unhook the positive clamp from the positive battery terminal.
- Use batteries for replacement from an authorized HYUNDAI dealer.

By jump starting

After a jump start from a good battery, drive the vehicle for 20-30 minutes before it is shutoff. The vehicle may not restart if you shut it off before the battery had a chance to adequately recharge. See "Jump Starting" in chapter 8 for more information on jump starting procedures.



Information



An inappropriately disposed battery can be harmful to the environment and human health. Dispose of the battery according to your local law(s) or regulation.

Reset Items

The following items may need to be reset after the battery has been discharged or the battery has been disconnected.

- Driving info/After recharging/Accumulated info (items in Utility view) (see chapter 4)
- Integrated memory system (see chapter 5)
- Power window (see chapter 5)
- Vision roof (see chapter 5)
- Power liftgate (see chapter 5)
- Climate control system (see chapter 5)
- Clock (see Infotainment system manual)
- Infotainment system (see Infotainment system manual)

TIRES AND WHEELS



WARNING

Tire failure may cause loss of vehicle control resulting in an accident. To reduce risk of **SERIOUS INJURY** or **DEATH**, take the following precautions:

- Inspect your tires monthly for proper inflation as well as wear and damage.
- The recommended cold tire pressure for your vehicle can be found in this manual and on the tire label located on the driver's side center pillar. Always use a tire pressure gauge to measure tire pressure. Tires with too much or too little pressure wear unevenly causing poor handling.
- Check the pressure of the spare every time you check the pressure of the other tires on your vehicle.
- Replace tires that are worn, show uneven wear, or are damaged. Worn tires can cause loss of braking effectiveness, steering control, or traction.
- **ALWAYS** replace tires with the same size, type, construction and tread pattern as each tire that was originally supplied with this vehicle. Using tires and wheels other than the recommended sizes could cause unusual handling characteristics, poor vehicle control, or negatively affect your vehicle's Anti-Lock Brake System (ABS) resulting in a serious accident.

Tire Care

For proper maintenance, safety, and maximum electric energy economy, you must always maintain recommended tire inflation pressures and stay within the load limits and weight distribution recommended for your vehicle.



All specifications (sizes and pressures) can be found on a label attached to the driver's side center pillar.

Recommended Cold Tire Inflation Pressures

All tire pressures (including the spare) should be checked when the tires are cold. "Cold tires" means the vehicle has not been driven for at least three hours or driven less than one mile (1.6 km).

Warm tires normally exceed recommended cold tire pressures by 4 to 6 psi (28 to 41 kPa). Do not release air from warm tires to adjust the pressure or the tires will be under-inflated. For recommended inflation pressure, refer to "Tire and Wheels" section in chapter 2.



WARNING

Recommended pressures must be maintained for the best ride, vehicle handling, and minimum tire wear.

Over-inflation or under-inflation can reduce tire life, adversely affect vehicle handling, and lead to sudden tire failure that could result in loss of vehicle control resulting in an accident.

Severe under-inflation can lead to severe heat build-up, causing blowouts, tread separation and other tire failures that can result in the loss of vehicle control resulting in an accident. This risk is much higher on hot days and when driving for long periods at high speeds.



CAUTION

- **Under-inflation results in excessive wear, poor handling and reduced electric energy economy. Wheel deformation is also possible. Keep your tire pressures at the proper levels. If a tire frequently needs refilling, have it checked by an authorized HYUNDAI dealer.**
- **Over-inflation produces a harsh ride, excessive wear at the center of the tire tread, and a greater possibility of damage from road hazards.**

Check Tire Inflation Pressure

Check your tires, including the spare tire, once a month or more.

How to check

Use a good quality tire pressure gauge to check tire pressure. You can not tell if your tires are properly inflated simply by looking at them. Radial tires may look properly inflated when they are under-inflated.

Remove the valve cap from the tire valve stem. Press the tire gauge firmly onto the valve to get a pressure measurement. If the cold tire inflation pressure matches the recommended pressure on the tire and loading information label, no further adjustment is necessary. If the pressure is low, add air until you reach the recommended pressure. Make sure to put the valve caps back on the valve stems. Without the valve cap, dirt or moisture could get into the valve core and cause air leakage. If a valve cap is missing, install a new one as soon as possible. If you overfill the tire, release air by pushing on the metal stem in the center of the tire valve. Recheck the tire pressure with the tire gauge. Be sure to put the valve caps back on the valve stems. Without the valve cap, dirt or moisture could get into the valve core and cause air leakage. If a valve cap is missing, install a new one as soon as possible.

Tire Rotation

To equalize tread wear, HYUNDAI recommends that the tires be rotated every 5,000 miles (8,000 km) or sooner if irregular wear develops.

During rotation, check the tires for correct balance.

When rotating tires, check for uneven wear and damage. Abnormal wear is usually caused by incorrect tire pressure, improper wheel alignment, out-of-balance wheels, severe braking or severe cornering. Look for bumps or bulges in the tread or side of the tire. Replace the tire if you find any of these conditions. Replace the tire if fabric or cord is visible. After rotation, be sure to bring the front and rear tire pressures to specification and check wheel lug nut tightness (proper torque is 11~13kgf·m (79~94 lbf·ft)).

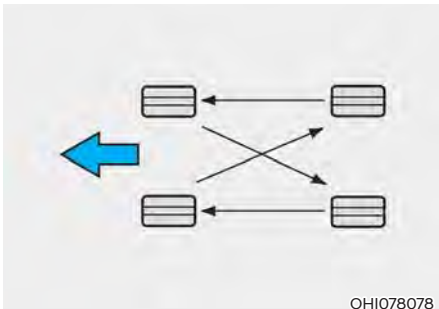

Disc brake pads should be inspected for wear whenever tires are rotated.

Information

The outside and inside of the unsymmetrical tire is distinguishable. When installing an unsymmetrical tire, be sure to install the side marked “outside” face the outside. If the side marked “inside” is installed on the outside, it will have a negative effect on vehicle performance.

WARNING

- Do not use the compact spare tire for tire rotation.
- Do not mix bias ply and radial ply tires under any circumstances. This may cause unusual handling characteristics that may cause loss of vehicle control resulting in an accident.

Wheel Alignment and Tire Balance

The wheels on your vehicle were aligned and balanced carefully at the factory to give you the longest tire life and best overall performance.

In most cases, you will not need to have your wheels aligned again. However, if you notice unusual tire wear or your vehicle pulling one way or the other, the alignment may need to be reset.

If you notice your vehicle vibrating when driving on a smooth road, your wheels may need to be rebalanced.

NOTICE

Incorrect wheel weights can damage your vehicle's aluminum wheels. Use only approved wheel weights.

Tire Replacement



[A] : Tread wear indicator

If the tire is worn evenly, a tread wear indicator will appear as a solid band across the tread. This shows there is less than 1/16 in. (1.6 mm) of tread left on the tire. Replace the tire when this happens.

Do not wait for the band to appear across the entire tread before replacing the tire.

WARNING

To reduce the risk of DEATH or SERIOUS INJURY:

- Replace tires that are worn, show uneven wear, or are damaged. Worn tires can cause loss of braking effectiveness, steering control, and traction.
- Always replace tires with the same size as each tire that was originally supplied with this vehicle. Using tires and wheels other than the recommended sizes could cause unusual handling characteristics, poor vehicle control, or negatively affect your vehicle's Anti-Lock Brake System (ABS) resulting in a serious accident.
- When replacing tires (or wheels), it is recommended to replace the two front or two rear tires (or wheels) as a pair. Replacing just one tire can seriously affect your vehicle's handling.
- Tires degrade over time, even when they are not being used. Regardless of the remaining tread, HYUNDAI recommends that tires be replaced after six (6) years of normal service.
- Heat caused by hot climates or frequent high loading conditions can accelerate the aging process. Failure to follow this warning may cause sudden tire failure, which could lead to a loss of vehicle control resulting in an accident.

Wheel Replacement

When replacing the metal wheels for any reason, make sure the new wheels are equivalent to the original factory units in diameter, rim width and offset.

Tire Traction

Tire traction can be reduced if you drive on worn tires, tires that are improperly inflated or on slippery road surfaces. Tires should be replaced when tread wear indicators appear. To reduce the possibility of losing control, slow down whenever there is rain, snow or ice on the road.

Tire Maintenance

In addition to proper inflation, correct wheel alignment helps to decrease tire wear. If you find a tire is worn unevenly, have your dealer check the wheel alignment.

When you have new tires installed, make sure they are balanced. This will increase vehicle ride comfort and tire life. Additionally, a tire should always be rebalanced if it is removed from the wheel.

Tire Sidewall Labeling

This information identifies and describes the fundamental characteristics of the tire and also provides the Tire Identification Number (TIN) for safety standard certification. The TIN can be used to identify the tire in case of a recall.

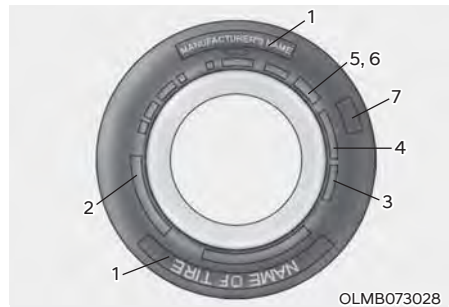

1. **Manufacturer or brand name**

Manufacturer or brand name is shown.

2. **Tire size designation**

A tire's sidewall is marked with a tire size designation. You will need this information when selecting replacement tires for your car. The following explains what the letters and numbers in the tire size designation mean.

Example tire size designation:

(These numbers are provided as an example only; your tire size designator could vary depending on your vehicle.)

235/55R19 105W

235 - Tire width in millimeters.

55 - Aspect ratio. The tire's section height as a percentage of its width.

R - Tire construction code (Radial).

19 - Rim diameter in inches.

105 - Load Index, a numerical code associated with the maximum load the tire can carry.

W - Speed Rating Symbol. See the speed rating chart in this section for additional information.

Wheel size designation

Wheels are also marked with important information that you need if you ever have to replace one. The following explains what the letters and numbers in the wheel size designation mean.

Example wheel size designation:

7.5J X 19

7.5 - Rim width in inches.

J - Rim contour designation.

19 - Rim diameter in inches.

Tire speed ratings

The chart below lists many of the different speed ratings currently being used for passenger vehicle tires. The speed rating is part of the tire size designation on the sidewall of the tire. This symbol corresponds to that tire's designed maximum safe operating speed.

Speed Rating Symbol	Maximum Speed
S	112 mph (180 km/h)
T	118 mph (190 km/h)
H	130 mph (210 km/h)
V	149 mph (240 km/h)
W	168 mph (270 km/h)
Y	186 mph (300 km/h)

3. Checking tire life (TIN : Tire Identification Number)

Any tires that are over six years old, based on the manufacturing date, (including the spare tire) should be replaced by new ones. You can find the manufacturing date on the tire sidewall (possibly on the inside of the wheel), displaying the DOT Code. The DOT Code is a series of numbers on a tire consisting of numbers and English letters. The manufacturing date is designated by the last four digits (characters) of the DOT code.

DOT : XXXX XXXX OOOO

The front part of the DOT shows a plant code number, tire size and tread pattern and the last four numbers indicate week and year manufactured.

For example:

DOT XXXX XXXX 1522 represents that the tire was produced in the 15th week of 2022.

4. Tire ply composition and material

The number of layers or plies of rubber-coated fabric in the tire. Tire manufacturers also must indicate the materials in the tire, which include steel, nylon, polyester, and others. The letter “R” means radial ply construction; the letter “D” means diagonal or bias ply construction; and the letter “B” means belted-bias ply construction.

5. Maximum permissible inflation pressure

This number is the greatest amount of air pressure that should be put in the tire. Do not exceed the maximum permissible inflation pressure. Refer to the Tire and Loading Information label for recommended inflation pressure.

6. Maximum load rating

This number indicates the maximum load in kilograms and pounds that can be carried by the tire. When replacing the tires on the vehicle, always use a tire that has the same load rating as the factory installed tire.

7. Uniform tire quality grading

Quality grades can be found where applicable on the tire sidewall between tread shoulder and maximum section width.

For example:
TREADWEAR 200
TRACTION AA
TEMPERATURE A

Tread wear

The tread wear grade is a comparative rating based on the wear rate of the tire when tested under controlled conditions on a specified government test course. For example, a tire graded 150 would wear one-and-a-half times (1½) as well on the government course as a tire graded 100.

The relative performance of tires depends upon the actual conditions of their use, however, and may depart significantly from the norm due to variations in driving habits, service practices and differences in road characteristics and climate.

These grades are molded on the sidewalls of passenger vehicle tires. The tires available as standard or optional equipment on your vehicle may vary with respect to grade.

Traction - AA, A, B & C

The traction grades, from highest to lowest, are AA, A, B and C. Those grades represent the tire's ability to stop on wet pavement as measured under controlled conditions on specified government test surfaces of asphalt and concrete. A tire marked C may have poor traction performance.



WARNING

The traction grade assigned to this tire is based on straight ahead braking traction tests, and does not include acceleration, cornering, hydroplaning, or peak traction characteristics.

Temperature - A, B & C

The temperature grades are A (the highest), B and C representing the tire's resistance to the generation of heat and its ability to dissipate heat when tested under controlled conditions on a specified indoor laboratory test wheel.

Sustained high temperature can cause the material of the tire to degenerate and reduce tire life, and excessive temperature can lead to sudden tire failure. Grades B and A represent higher levels of performance on the laboratory test wheel than the minimum required by law.



WARNING

The temperature grade for this tire is established for a tire that is properly inflated and not overloaded. Excessive speed, under-inflation, over-inflation, or excessive loading, either separately or in combination, can cause heat build-up and possible sudden tire failure. This may cause loss of vehicle control resulting in an accident.

Tire Terminology and Definitions

Air pressure

The amount of air inside the tire pressing outward on the tire. Air pressure is expressed in pounds per square inch (psi) or kilopascal (kPa).

Accessory weight

This means the combined weight of optional accessories. Some examples of optional accessories are automatic transmission, power seats, and air conditioning.

Aspect ratio

The relationship of a tire's height to its width.

Belt

A rubber coated layer of cords that is located between the plies and the tread. Cords may be made from steel or other reinforcing materials.

Bead

The tire bead contains steel wires wrapped by steel cords that hold the tire onto the rim.

Bias ply tire

A pneumatic tire in which the plies are laid at alternate angles less than 90 degrees to the centerline of the tread.

Cold tire pressure

The amount of air pressure in a tire, measured in pounds per square inch (psi) or kilopascals (kPa) before a tire has built up heat from driving.

Curb weight

This means the weight of a motor vehicle with standard and optional equipment including the maximum capacity of fuel, oil and coolant, but without passengers and cargo.

DOT markings

A code molded into the sidewall of a tire signifying that the tire is in compliance with the U.S. Department of Transportation motor vehicle safety standards. The DOT code includes the Tire Identification Number (TIN), an alphanumeric designator which can also identify the tire manufacturer, production plant, brand and date of production.

GVWR

Gross Vehicle Weight Rating

GAWR FRT

Gross Axle Weight Rating for the Front Axle.

GAWR RR

Gross Axle Weight Rating for the Rear axle.

Intended outboard sidewall

The side of an asymmetrical tire, that must always face outward when mounted on a vehicle.

Kilopascal (kPa)

The metric unit for air pressure.

Light Truck (LT) tire

A tire designated by its manufacturer as primarily intended for use on lightweight trucks or multipurpose passenger vehicles.

Load ratings

The maximum load that a tire is rated to carry for a given inflation pressure.

Load index

An assigned number ranging from 1 to 279 that corresponds to the load carrying capacity of a tire.

Maximum inflation pressure

The maximum air pressure to which a cold tire may be inflated. The maximum air pressure is molded onto the sidewall.

Maximum load rating

The load rating for a tire at the maximum permissible inflation pressure for that tire.

Maximum loaded vehicle weight

The sum of curb weight; accessory weight; vehicle capacity weight; and production options weight.

Normal occupant weight

The number of occupants a vehicle is designed to seat multiplied by 150 pounds (68 kg).

Occupant distribution

Designated seating positions.

Outward facing sidewall

An asymmetrical tire has a particular side that faces outward when mounted on a vehicle. The outward facing sidewall bears white lettering or bears manufacturer, brand, and/or model name molding that is higher or deeper than the same moldings on the inner facing sidewall.

Passenger (P-Metric) tire

A tire used on passenger cars and some light duty trucks and multipurpose vehicles.

Ply

A layer of rubber-coated parallel cords.

Pneumatic tire

A mechanical device made of rubber, chemicals, fabric and steel or other materials, that, when mounted on an automotive wheel provides the traction and contains the gas or fluid that sustains the load.

Pneumatic options weight

The combined weight of installed regular production options weighing over 5 lb. (2.3 kg) in excess of the standard items which they replace, not previously considered in curb weight or accessory weight, including heavy duty breaks, ride levelers, roof rack, heavy duty battery, and special trim.

Recommended inflation pressure

Vehicle manufacturer's recommended tire inflation pressure as shown on the tire placard.

Radial ply tire

A pneumatic tire in which the ply cords that extend to the beads are laid at 90 degrees to the centerline of the tread.

Rim

A metal support for a tire and upon which the tire beads are seated.

Sidewall

The portion of a tire between the tread and the bead.

Speed rating

An alphanumeric code assigned to a tire indicating the maximum speed at which a tire can operate.

Traction

The friction between the tire and the road surface. The amount of grip provided.

Tread

The portion of a tire that comes into contact with the road.

Treadwear indicators

Narrow bands, sometimes called “wear bars”, that show across the tread of a tire when only 1/16 inch of tread remains.

UTQGS

Uniform Tire Quality Grading Standards is a tire information system that provides consumers with ratings for a tire’s traction, temperature and treadwear. Ratings are determined by tire manufacturers using government testing procedures. The ratings are molded into the sidewall of the tire.

Vehicle capacity weight

The number of designated seating positions multiplied by 150 lbs. (68 kg) plus the rated cargo and luggage load.

Vehicle maximum load on the tire

Load on an individual tire due to curb and accessory weight plus maximum occupant and cargo weight.

Vehicle normal load on the tire

Load on an individual tire that is determined by distributing to each axle its share of the curb weight, accessory weight, and normal occupant weight and dividing by 2.

Vehicle placard

A label permanently attached to a vehicle showing the original equipment tire size and recommended inflation pressure.

All Season Tires

HYUNDAI specifies all season tires on some models to provide good performance for use all year round, including snowy and icy road conditions. All season tires are identified by ALL SEASON and/or M+S (Mud and Snow) on the tire sidewall. Snow tires have better snow traction than all season tires and may be more appropriate in some areas.

Summer Tires

HYUNDAI specifies summer tires on some models to provide superior performance on dry roads. Summer tire performance is substantially reduced in snow and ice. Summer tires do not have the tire traction rating M+S (Mud and Snow) on the tire side wall. If you plan to operate your vehicle in snowy or icy conditions, Genesis Branded Vehicle recommends the use of snow tires or all season tires on all four wheels.

Snow Tires

If you equip your car with snow tires, they should be the same size and have the same load capacity as the original tires. Snow tires should be installed on all four wheels; otherwise, poor handling may result. Snow tires should carry 4 psi (28 kPa) more air pressure than the pressure recommended for the standard tires on the tire label on the driver's side of the center pillar, or up to the maximum pressure shown on the tire sidewall, whichever is less. Do not drive faster than 75 mph (120 km/h) when your vehicle is equipped with snow tires.

Radial-Ply Tires

Radial-ply tires provide improved tread life, road hazard resistance and smoother high speed ride. The radial-ply tires used on this vehicle are of belted construction, and are selected to complement the ride and handling characteristics of your vehicle. Radial-ply tires have the same load carrying capacity, as bias-ply or bias belted tires of the same size, and use the same recommended inflation pressure. Mixing of radial-ply tires with bias-ply or bias belted tires is not recommended. Any combinations of radial-ply and bias-ply or bias belted tires when used on the same vehicle will seriously deteriorate vehicle handling. The best rule to follow is: Identical pairs of radial-ply tires should always be used as a set for the front tires and a set for the rear tires.

Longer wearing tires can be more susceptible to irregular tread wear. It is very important to follow the tire rotation interval in this chapter to achieve the tread life potential of these tires. Cuts and punctures in radial-ply tires are repairable only in the tread area, because of sidewall flexing. Consult your tire dealer for radial-ply tire repairs.



WARNING

Do not mix bias ply and radial ply tires under any circumstances. This may cause unusual handling characteristics that may cause loss of vehicle control resulting in an accident.

Low Aspect Ratio Tires

The aspect ratio is lower than 50 on low aspect ratio tires.

Because low aspect ratio tires are optimized for handling and braking, their sidewall is a little stiffer than a standard tire. Also, low aspect ratio tires tend to be wider so that they consequently have a greater contact patch with the road surface. In some instances, they may generate more road noise compared with standard tires.



CAUTION

The side wall of a low aspect ratio tire is shorter than the normal one. Thus, the low-aspect wheel and tire are easily damaged. Follow the below instructions.

- **When driving on a rough road or driving off a road, be careful not to damage the tires and wheels. After driving, inspect the tires and wheels.**
- **When passing over a pothole, speed bump, manhole, or curb stone, drive the vehicle slowly so as not to damage the tires and wheels.**
- **When there is an impact on a tire, inspect the tire condition. Or, contact an authorized retailer of Genesis Branded products.**
- **Inspect the tire condition and pressure every 1,800 miles (3,000 km) to prevent tire damage.**
- **It is difficult to recognize a tire damage only with your eyes. When there is a slight hint of a tire damage, check and replace the tire to prevent the damage caused by air leakage.**
- **When a tire is damaged while driving on a rough road, off a road, or over obstacles, such as a pothole, manhole, or curb stone, your warranty does not cover the damage.**
- **The tire information is specified on the tire side wall.**

FUSES

■ Blade type



Normal



Blown

■ Cartridge type



Normal



Blown

■ Multi type

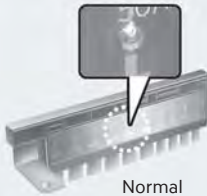

Normal

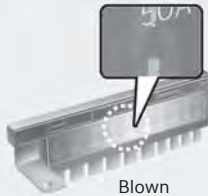

Blown

OTM078035

A vehicle's electrical system is protected from electrical overload damage by fuses.

This vehicle has 2 (or 3) fuse panels, one located in the driver's side panel bolster, the other in the vehicle compartment.

If any of your vehicle's lights, accessories, or controls do not work, check the appropriate circuit fuse. If a fuse has blown, the element inside the fuse will be melted or broken.

If the electrical system does not work, first check the driver's side fuse panel. Before replacing a blown fuse, turn the vehicle and all switches off, and then disconnect the negative battery cable. Always replace a blown fuse with one of the same rating.

If the replacement fuse blows, this indicates an electrical problem. Avoid using the system involved. Consult an authorized HYUNDAI dealer.



WARNING

NEVER replace a fuse with anything but another fuse of the same rating.

- A higher capacity fuse could cause damage and possibly cause a fire.
- Do not install a wire or aluminum foil instead of the proper fuse - even as a temporary repair. It may cause extensive wiring damage and possibly a fire.

NOTICE

Do not use a screwdriver or any other metal object to remove fuses because it may cause a short circuit and damage the system.

Instrument Panel Fuse Replacement

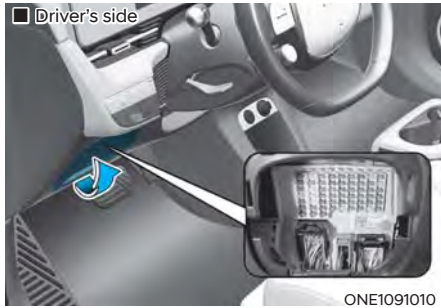

1. Turn the vehicle off.
2. Turn all other switches off.
3. Open the fuse panel cover.
4. Refer to the label on the inside of the fuse panel cover to locate the suspected fuse location.

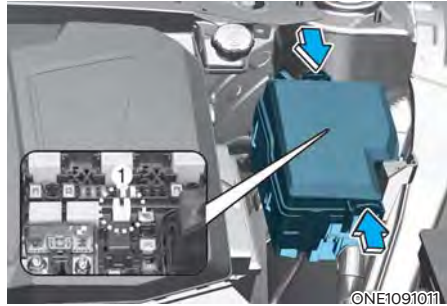

5. Pull the suspected fuse straight out. Use the removal tool (1) provided in the motor compartment fuses panel cover.
6. Check the removed fuse; replace it if it is blown. Spare fuses are provided in the instrument panel fuse panels (or in the motor compartment fuse panel).
7. Push in a new fuse of the same rating, and make sure it fits tightly in the clips. If it fits loosely, consult an authorized HYUNDAI dealer.

In an emergency, if you do not have a spare fuse, use a fuse of the same rating from a circuit you may not need for operating the vehicle, such as the cigarette lighter fuse.

If the headlights or other electrical components do not work and the fuses are undamaged, check the fuse panel in the motor compartment. If a fuse is blown, it must be replaced with the same rating.

Motor Compartment Panel Fuse Replacement

Blade fuse / Cartridge fuse

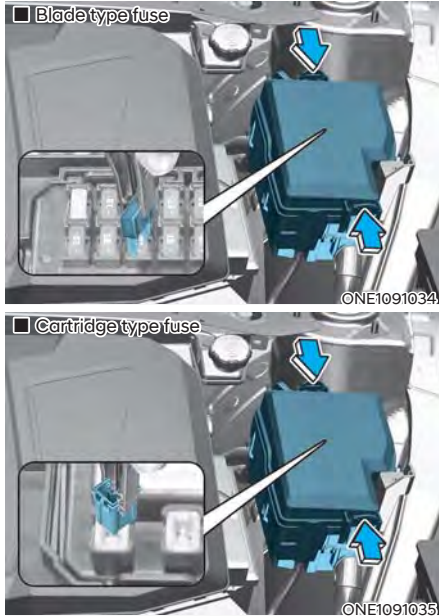

1. Turn the vehicle off.
2. Turn all other switches off.
3. Remove the fuse panel cover by pressing the tap and pulling up.
4. Check the removed fuse; replace it if it is blown. To remove or insert the fuse, use the fuse puller in the motor compartment fuse panel.
5. Push in a new fuse of the same rating, and make sure it fits tightly in the clips. If it fits loosely, consult an authorized HYUNDAI dealer.

NOTICE

After checking the fuse panel in the motor compartment, securely install the fuse panel cover. You may hear a clicking sound if the cover is securely latched. If it is not securely latched, electrical failure may occur from water contact.

Multi fuse

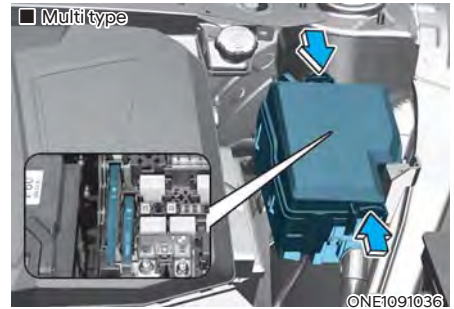

If the multi fuse is blown, consult an authorized HYUNDAI dealer.

Fuse/Relay Panel Description

Instrument panel fuse panel



ONE1091012

Inside the fuse/relay box cover, you can find the fuse/relay label describing fuse/relay names and ratings.

i Information

Not all fuse panel descriptions in this manual may be applicable to your vehicle; the information is accurate at the time of printing. When you inspect the fuse box on your vehicle, refer to the fuse box label.

CHILD LOCK	15A	B/HEATER REAR	20A		A/BAG IND	7.5A		² MEMORY	START	7.5A	² SOLAR CHARGER	HEATED MIRROR	10A
TAILGATE OPEN	² 15A	EPCU	10A		³ MODULE	CLUSTER	7.5A	⁸ IG3	⁷ IG3	10A	IAU	¹ SOLAR CHARGER / VISOR / ROOF	20A
AFCU	10A	B/HEATER DRV/PASS	20A	WASHER		² IBU	7.5A	⁹ IG3		10A	BATTERY MANAGEMENT	² AIR BAG	10A
		P/WINDOW LH	25A	¹ SPARE	³ E-SHIFTER	⁴ MODULE	10A	USB CHARGER	¹ MEMORY	15A	² SPARE	OMU	15A
AMP	25A	P/WINDOW RH	25A	⁵ MODULE	⁵ MODULE				E-CALL	10A	¹ IBU	BRAKE SWITCH	10A
P/SEAT DRV	30A	P/SEAT REAR RH	30A	¹ A/C	¹ AIR BAG	15A		² MODULE	MULTI MEDIA	15A	¹ DOOR LOCK	¹ MODULE	10A
P/SEAT PASS	30A	P/SEAT REAR LH	30A	⁷ MODULE	7.5A								

USE THE DESIGNATED FUSE ONLY
UTILISEZ SEULEMENT LE FUSIBLE DÉSIGNÉS

 P/NO: 91990-G1620

ONE1091046N

Instrument panel fuse panel

Fuse Name	Fuse Rating	Circuit Protected
Child Lock	15A	Child Lock Relay, Child Unlock Relay
A/BAG IND	7.5A	Overhead Console
MEMORY2	10A	Head-Up Display
START	7.5A	VCU, IBU
S/CHARGE2	20A	SDC
MIRR HTR	10A	Driver Outside Mirror Unit, Passenger Outside Mirror Unit
T/GATE	15A	Liftgate Release Relay
EPCU2	10A	Rear Inverter
MODULE3	7.5A	Multifunction Switch, IBU, Stop Lamp Switch, Driver Door Module
CLUSTER	7.5A	Head-Up Display, Instrument Cluster
IG3 8	10A	V2L Unit, ICCU, VCMS, Rear Electronic Oil Pump, CDM
IG3 7	10A	Incar Temperature Sensor, A/V & Navigation Head Unit, A/C PTC Heater, A/C Control Module, Instrument Cluster, High-Voltage Charging Lamp
IAU	10A	IAU, BLE UNIT
S/CHARGER/VISION ROOF	20A	SDC, Vision Roof
AFCU	10A	AFCU, Driver/Passenger Door Outside Handle

Instrument panel fuse panel

Fuse Name	Fuse Rating	Circuit Protected
FRT SEAT HEATER	20A	Front Air Ventilation Seat Control Module, Front Seat Warmer Control Module
WASHER	15A	Multifunction Switch
IBU2	7.5A	IBU
IG3 9	10A	SCU, Rear Inverter, BMU
BMS	10A	BMU
A/BAG2	10A	SRS Control Module
WIN LH	25A	Driver Safety Power Window Module, Passenger Safety Power, Rear Power Window Switch LH
SPARE1	15A	Not Used
E-SHIFTER3	10A	Electronic ATM Shift Lever
MODULE4	10A	Front/Rear Corner Radar LH/RH, Front/Rear Inverter, Crash Pad Switch, ADAS Driving ECU, VESS Unit, Front Radar, Front View Camera, ADAS Parking ECU
USB CHARGER	15A	Front USB Charger #1, Front USB Charger #2

Instrument panel fuse panel

Fuse Name	Fuse Rating	Circuit Protected
MEMORY1	15A	ICU Junction Block (Fuse F6), Instrument Cluster, A/C Control Module, Mood Lamp Unit
SPARE2	10A	Not Used
OMU	15A	Driver/Passenger Outside Mirror Unit, Driver Door Module
AMP	25A	AMP
WIN RH	25A	Passenger Safety Power Window Module, Driver Safety Power, Rear Power Window Switch RH
MODULE6	7.5A	IBU, IAU
MODULE5	10A	Data Link Connector, Electro Chromic Mirror, E-CALL Unit, A/V & Navigation Head Unit, Crash Pad Switch, Head Lamp LH/RH, SDC, AMP, Smart Phone Wireless Charger, Driver/Passenger Power Seat Module, Front Air Ventilation Seat Control Module, Front Seat Warmer Control, Module, Rear Power Seat LH/RH Module
E-CALL	10A	Not Used
IBU1	15A	IBU
BRAKE SWITCH	10A	Stop Lamp Switch, IBU
P/SEAT DRV	30A	Driver Power Seat Switch, Driver Power Seat Module (With IMS)

Instrument panel fuse panel

Fuse Name	Fuse Rating	Circuit Protected
P/SEAT RR RH	30A	Rear Power Seat RH Module
A/C1	7.5A	A/C Control Module
A/BAG1	15A	SRS Control Module
MODULE2	10A	AMP, P/E Junction Block (Power Outlet Relay (RLY.11)), IBU, ADAS Unit (Parking), A/V & Navigation Keyboard, A/V & Navigation Head Unit
MULTIMEDIA	15A	A/V & Navigation Head Unit
DR LOCK	20A	Door Lock Relay, Door Unlock Relay
MODULE1	10A	Hazard Lamp Switch, Multifunction Switch, Data Link Connector, Rain Sensor, P/R Junction Block (Blower Relay (RLY.9)), Driver/Passenger Door Speaker Mood Lamp, Driver/Passenger Door Arm Rest Mood Lamp, Rear Door Mood Lamp LH/RH, PTG Unit, Rear Power Seat LH/RH Module, Driver/Passenger Power Seat Module
P/SEAT PASS	30A	Passenger Power Seat Switch, Passenger Power Seat Module
P/SEAT RR LH	30A	Rear Power Seat LH Module

Motor compartment fuse panel

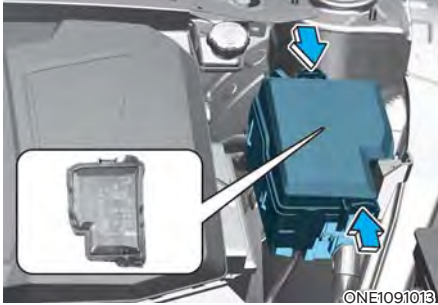

ONE1091013

Inside the fuse/relay box cover, you can find the fuse/relay label describing fuse/relay names and ratings.

i Information

Not all fuse panel descriptions in this manual may be applicable to your vehicle; the information is accurate at the time of printing. When you inspect the fuse panel in your vehicle, refer to the fuse panel label.

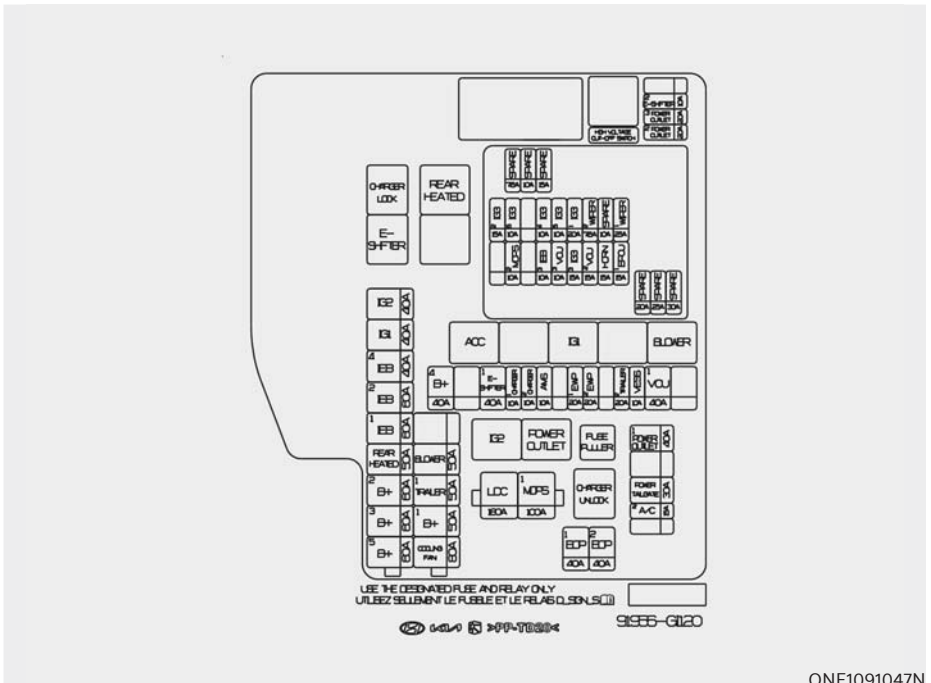

ONE1091047N

Motor compartment fuse panel

Type	Fuse Name	Fuse Rating	Circuit Protected
MULTI FUSE-1	LDC	180A	P/R Junction Block (Fuse : F15, F17, F20, F21)
	MDPS1	100A	MDPS Unit
MULTI FUSE-2	B+5	60A	PCB Block (IG3 Main Relay, Fuse : F1, F2, F3, F4, F6)
	B+3	60A	ICU Junction Block (Fuse : F1, F2, F10, F11, F19, F20,F29, F37, F38, F46, F47, F55, F56)
	B+2	60A	ICU Junction Block (IPS1, IPS4, IPS6, IPS8, IPS9, IPS10)
	RR HTD	50A	P/R Junction Block (RLY.3)
	IEB1	60A	IEB Unit
	IEB2	60A	IEB Unit
	IEB4	40A	Multipurpose Check Connector
	IG1	40A	P/R Junction Block (RLY.5, RLY.7)
MULTI FUSE-3	IG2	40A	P/R Junction Block (RLY.10)
	C/FAN	80A	Cooling Fan Motor
	B+1	50A	ICU Junction Block (IPS2, IPS3, IPS4, IPS5)
	TRAILER1	50A	Trailer Connector Unit
	BLOWER	50A	P/R Junction Block (RLY.9)

Type	Fuse Name	Fuse Rating	Circuit Protected
FUSE	B+4	40A	ICU Junction Block (Long Term Load Latch Relay, Fuse : F8, F17, F18, F26, F27, F35, F36, F45, F44, F53, F54)
	E-SHIFTER1	40A	P/R Junction Block (RLY.2, Fuse : F22)
	CHARGER1	10A	P/R Junction Block (RLY.1, RLY.12), ICCU, VCMS
	CHARGER2	10A	CDM
	AMS	10A	12V Battery Sensor
	EWP1	20A	Electronic Water Pump #1
	EWP2	20A	Electronic Water Pump #2
	TRAILER2	20A	Trailer Connector Unit
	VESS	10A	VESS Unit
	VCU1	40A	VCU

Type	Fuse Name	Fuse Rating	Circuit Protected
FUSE	P/OUTLET1	40A	P/R Junction Block (RLY.11)
	T/GATE	30A	PTG Unit
	A/C2	15A	A/C Control Module
	EOP1	40A	Rear Electronic Oil Pump
	EOP2	40A	Front Electronic Oil Pump (AWD)
	E-SHIFTER2	10A	P/R Junction Block (RLY.2), SCU, Electronic ATM Shift Lever
	P/OUTLET3	20A	Rear Power Outlet
	P/OUTLET2	20A	Front Power Outlet

Fuse Name	Fuse Rating	Circuit Protected
WIPER1	25A	PCB Block (Wiper Main Relay)
EPCU1	15A	Front Inverter (AWD)
HORN	15A	PCB Block (Horn Relay), PCB Block (Burglar Alarm Horn Relay)
WIPER2	7.5A	IBU
VCU2	15A	VCU
IG3 1	20A	ICU Junction Block (Fuse : F14, F16, F24)
IG3 3	15A	Electronic Water Pump
IG3 5	10A	BMS Coolant 3Way Valve
VCU3	10A	VCU
IG3 4	10A	A/C Coolant Valve, Electronic Water Pump #1, #2, Electronic A/C Compressor
IEB3	10A	Multipurpose Check Connector, IEB Unit
IG3 6	10A	Cooling Fan Motor, Front Electronic Oil Pump (AWD)
MDPS2	10A	MDPS Unit
IG3 2	15A	Front Inverter (AWD), VCU

LIGHT BULBS

Consult an authorized HYUNDAI dealer to replace most vehicle light bulbs. It is difficult to replace vehicle light bulbs because other parts of the vehicle must be removed before you can get to the bulb. This is especially true for removing the headlight assembly to get to the bulb(s).

Removing/installing the headlight assembly can result in damage to the vehicle.



WARNING

- Prior to working on a light, depress the foot brake, shift to P (Park), apply the parking brake, press the Start/ Stop button to the OFF position and take the key with you when leaving the vehicle to avoid sudden movement of the vehicle and to prevent possible electric shock.
- Be aware the bulbs may be hot and may burn your fingers.

NOTICE

Be sure to replace the burned-out bulb with one of the same wattage rating. Otherwise, it may cause damage to the fuse or electrical wiring system.

NOTICE

To prevent damage, do not clean the headlight lens with chemical solvents or strong detergents.



Information - Headlight desiccant (if equipped)

This vehicle is equipped with desiccant to reduce fogging inside the headlight due to moisture. The desiccant is consumable and its performance may change based on the used period or environment. If fogging inside the headlight due to moisture continues for a long time, consult an authorized HYUNDAI dealer.



Information

The headlight and tail lamp lenses could appear frosty if the vehicle is washed after driving or the vehicle is driven at night in wet weather. This condition is caused by temperature difference between the lamp inside and outside and, it does not indicate a problem with your vehicle. When moisture condenses in the lamp, it will be removed after driving with the headlight on. The removable level may differ depending on lamp size, lamp position and environmental condition. However, if moisture is not removed, have your vehicle inspected by an authorized HYUNDAI dealer.

i Information

- A normally functioning lamp may flicker momentarily to stabilize the vehicle's electrical control system. However, if the lamp goes out after flickering momentarily, or continues to flicker momentarily, or continues to flicker, have the system checked by an authorized HYUNDAI dealer.
- The Parking lamp may not turn on when the Parking lamp switch is turned on, but the Parking lamp and headlight switch may turn on when the headlight switch is turned on. This may be caused by network failure or vehicle electrical control system malfunction. If this occurs, have the system checked by an authorized HYUNDAI dealer.

i Information

The headlight aiming should be adjusted after an accident or after the headlight assembly is reinstalled.

Headlight, Parking Lamp, Turn Signal Lamp, Daytime Running Light (DRL) Replacement

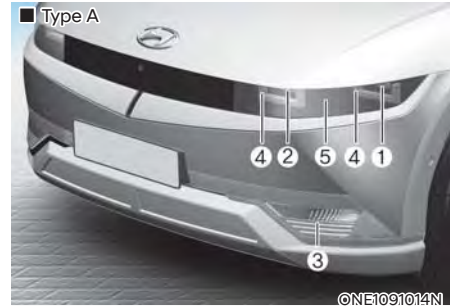

■ Type A

- (1) Headlight (High/Low)
- (2) Headlight (Low)
- (3) Turn signal lamp (Bulb type)
- (4) Parking lamp/Daytime running light (DRL)
- (5) Front side marker (LED)

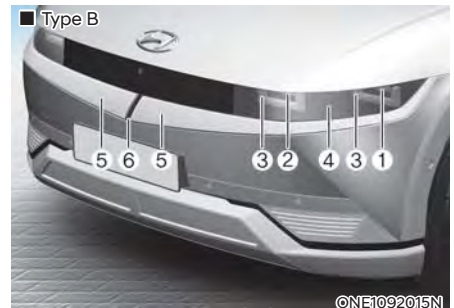

■ Type B

- (1) Headlight (Low)
- (2) Headlight (High)
- (3) Parking lamp/Daytime running light/ Turn signal lamp (LED) (if equipped)
- (4) Front side marker (LED) (if equipped)
- (5) Garnish hidden lighting (if equipped)
- (6) Charging display lamp (If equipped)

If the LED lamp does not operate, have the system inspected by an authorized HYUNDAI dealer.

The LED lamps cannot be replaced as a single unit because it is an integrated unit. The LED lamps has to be replaced with the unit.

A skilled technician should check or repair the LED lamp, for it may damage related parts of the vehicle.

Turn signal lamp (bulb type)

1. Engage the parking brake and disconnect the negative battery cable.
2. Remove wheel guard clips (under the front bumper).
3. Push the wheel guard aside and remove the bulb socket by turning it counterclockwise.
4. Remove the bulb from the socket by pressing it in and rotating it counterclockwise until the tabs on the bulb align with the slots in the socket. Pull the bulb out of the socket.
5. Install a new bulb by inserting it into the socket and rotating it until it locks into place.
6. Push the socket into the assembly and turn the socket clockwise.
7. Install the wheel guard in the reverse order.



WARNING

- **Wear eye protection when changing a bulb. Allow the bulb to cool down before handling it.**
- **Always handle them carefully, and avoid scratches and abrasions. If the bulbs are lit, avoid contact with liquids.**
- **Never touch the glass with bare hands. Residual oil may cause the bulb to overheat and burst when lit.**
- **A bulb should be operated only when installed in a turn signal lamp.**
- **If a bulb becomes damaged or cracked, replace it immediately and carefully dispose of it.**
- **Replacing the bulb may cause damage to the bulb relevant parts of the vehicle, and also may cause injuries. To replace the turn signal lamp, visit an authorized HYUNDAI dealer.**

Side Repeater Lamp Replacement



If the LED lamp (1) does not operate, have the system inspected by an authorized HYUNDAI dealer.

The LED lamps cannot be replaced as a single unit because it is an integrated unit. The LED lamps has to be replaced with the unit.

A skilled technician should check or repair the LED lamp, for it may damage related parts of the vehicle.

Rear Combination Lamp Replacement

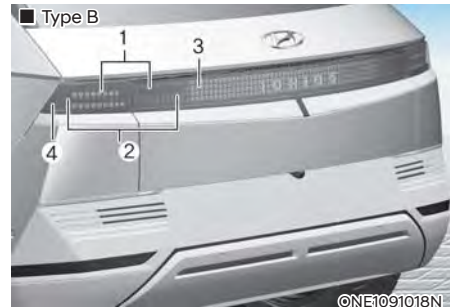
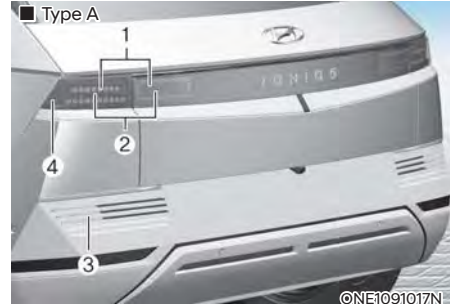

- (1) Rear lamp/Stop lamp
- (2) Stop lamp/Turn signal lamp
- (3) Reverse lamp
 - Type A : Bulb
 - Type B : LED (if equipped)
- (4) Rear side marker (LED)

If the LED lamp does not operate, have the system inspected by an authorized HYUNDAI dealer.

The LED lamps cannot be replaced as a single unit because it is an integrated unit. The LED lamps has to be replaced with the unit.

A skilled technician should check or repair the LED lamp, for it may damage related parts of the vehicle.

Reverse lamp (bulb type)

1. Disconnect the negative battery cable.
2. Loosen the retaining clips under the bumper and screws on the wheel house trim.
3. Prey trim under the bumper toward the vehicle.
4. Remove the socket from the assembly by turning the socket counterclockwise until the tabs on the socket align with the slots on the assembly.
5. Remove the bulb by pulling it straight out.
6. Insert a new bulb in the socket.
7. Reinstall the light assembly to the body of the vehicle.



WARNING

- **Wear eye protection when changing a bulb. Allow the bulb to cool down before handling it.**
- **Always handle them carefully, and avoid scratches and abrasions. If the bulbs are lit, avoid contact with liquids.**
- **Never touch the glass with bare hands. Residual oil may cause the bulb to overheat and burst when lit.**
- **A bulb should be operated only when installed in a turn signal lamp.**
- **If a bulb becomes damaged or cracked, replace it immediately and carefully dispose of it.**
- **Replacing the bulb may cause damage to the bulb relevant parts of the vehicle, and also may cause injuries. To replace the turn signal lamp, visit an authorized HYUNDAI dealer.**

High Mounted Stop Lamp Replacement

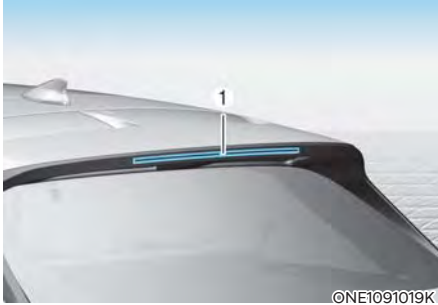

If the LED lamp (1) does not operate, have the system inspected by an authorized HYUNDAI dealer.

The LED lamps cannot be replaced as a single unit because it is an integrated unit. The LED lamps has to be replaced with the unit.

A skilled technician should check or repair the LED lamp, for it may damage related parts of the vehicle

License Plate Lamp Replacement



If the LED lamp (1) does not operate, have the system inspected by an authorized HYUNDAI dealer.

The LED lamps cannot be replaced as a single unit because it is an integrated unit. The LED lamps has to be replaced with the unit.

A skilled technician should check or repair the LED lamp, for it may damage related parts of the vehicle.

Front Trunk Lamp Replacement

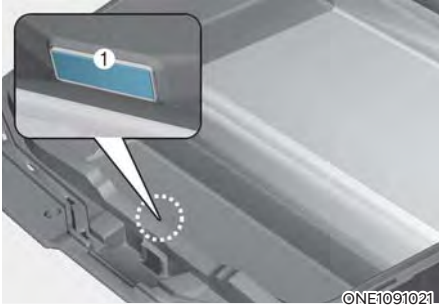

If the LED lamp (1) does not operate, have the system inspected by an authorized HYUNDAI dealer.

The LED lamps cannot be replaced as a single unit because it is an integrated unit. The LED lamps has to be replaced with the unit.

A skilled technician should check or repair the LED lamp, for it may damage related parts of the vehicle.

Interior Light Replacement



■ First row lamp (if equipped)



■ Rear seat room lamp (without vision roof/solar roof)



■ Rear seat personal lamp (with vision roof/solar roof)



If the LED lamp (1) does not operate, have the system inspected by an authorized HYUNDAI dealer.

The LED lamps cannot be replaced as a single unit because it is an integrated unit. The LED lamps has to be replaced with the unit.

A skilled technician should check or repair the LED lamp, for it may damage related parts of the vehicle.

Vanity mirror lamp and luggage compartment lamp (Bulb type)



1. Apply the parking brake and place the Start/Stop button in the OFF position.
2. Turn off the lights.
3. Using a flat-head screwdriver, gently pry the lens from the interior light housing.
4. Remove the bulb by pulling it straight out.
5. Insert a new bulb into the socket.
6. Align the lens tabs with the interior light housing notches and snap the lens into place.

NOTICE

Use care not to dirty or damaged lenses, lens tabs, and plastic housings.

APPEARANCE CARE

Exterior Care

NOTICE

If you park your vehicle near a stainless steel sign or glass facade building, the vehicle's exterior plastic parts such as a bumper, spoiler, garnish, lamp or side view mirror might be damaged due to sunlight reflected from the sign or building. To prevent damage of the exterior plastic parts, you should avoid parking in areas where light may be reflected or use a car cover. (The exterior plastic parts applied to your vehicle may vary.)

Exterior general caution

It is very important to follow the label directions when using any chemical cleaner or polish. Read all warning and caution statements that appear on the label.

Finish maintenance

Washing

To help protect your vehicle's finish from rust and deterioration, wash it thoroughly and frequently at least once a month with lukewarm or cold water.

If you use your vehicle for off-road driving, you should wash it after each off-road trip. Pay special attention to the removal of any accumulation of salt, dirt, mud, and other foreign materials. Make sure the drain holes in the lower edges of the doors and rocker panels are kept clear and clean.

Insects, tar, tree sap, bird droppings, industrial pollution and similar deposits can damage your vehicle's finish if not removed immediately.

Even prompt washing with plain water may not completely remove all these deposits. A mild soap, safe for use on painted surfaces, should be used.

After washing, rinse the vehicle thoroughly with lukewarm or cold water. Do not allow soap to dry on the finish.

High-pressure washing

- When using high-pressure washers, make sure to maintain sufficient distance from the vehicle.
Insufficient clearance or excessive pressure can lead to component damage or water penetration.
- Do not spray the camera, sensors or its surrounding area directly with a high pressure washer. Shock applied from high pressure water may cause the device to not operate normally.
- Do not bring the nozzle tip close to boots (rubber or plastic covers) or connectors as they may be damaged if they come into contact with high pressure water.



WARNING

After washing the vehicle, test the brakes while driving slowly to see if they have been affected by water before getting on the road. If braking performance is impaired, dry the brakes by applying them lightly while maintaining a slow forward speed.

NOTICE

- Do not use strong soap, chemical detergents or hot water, and do not wash the vehicle in direct sunlight or when the body of the vehicle is warm.
- Be careful when washing the side windows of your vehicle.
- Especially, with high-pressure water, water may leak through the windows and wet the interior.
- To prevent damage to the plastic parts, do not clean with chemical solvents or strong detergents.

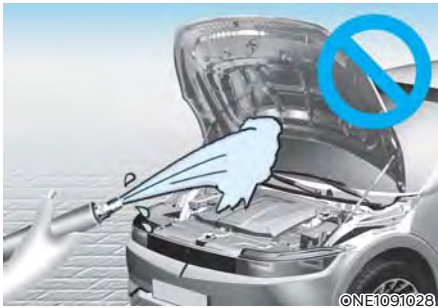
NOTICE

- Water washing in the motor compartment including high pressure water washing may cause the failure of electrical circuits located in the vehicle compartment.
- Never allow water or other liquids to come in contact with electrical/ electronic components inside the vehicle as water or other liquids may flow in to the motor compartment through the front trunk and damage electrical/electronic components.

NOTICE

Matte paint finish vehicle (if equipped)
Automatic car wash which uses rotating brushes should not be used as this can damage the surface of your vehicle. A steam cleaner which washes the vehicle surface at high temperature may result the oil to adhere and leave stains that is difficult to remove.

Use a soft cloth (for example, microfiber towel or sponge) when washing your vehicle and dry with a microfiber towel. When you hand wash your vehicle, you should not use a cleaner that finishes with wax. If the vehicle surface is too dirty (sand, dirt, dust, contaminant, etc.), clean the surface with water before washing the car.

Waxing

A good coat of wax is a barrier between your paint and contaminate. Keeping a good coat of wax on your vehicle will help protect it.

Wax the vehicle when water will no longer bead on the paint.

Always wash and dry the vehicle before waxing. Use a good quality liquid or paste wax, and follow the manufacturer's instructions. Wax all metal trim to protect it and to maintain its luster.

Removing oil, tar, and similar materials with a spot remover will usually strip the wax from the finish. Be sure to re-wax these areas even if the rest of the vehicle does not yet need waxing.

NOTICE

- Wiping dust or dirt off the body with a dry cloth will scratch the finish.
- Do not use steel wool, abrasive cleaners, or strong detergents containing highly alkaline or caustic agents on chrome-plated or anodized aluminum parts. This may result in damage to the protective coating and cause discoloration or paint deterioration.

NOTICE

Matte paint finish vehicle (if equipped)
Do not use any polish protector such as a detergent, an abrasive and a polish. In case wax is applied, remove the wax immediately using a silicon remover and if any tar or tar contaminant is on the surface use a tar remover to clean. However, be careful not to apply too much pressure on the painted area.

Finish damage repair

Deep scratches or stone chips in the painted surface must be repaired promptly. Exposed metal will quickly rust and may develop into a major repair expense.

NOTICE

If your vehicle is damaged and requires any metal repair or replacement, be sure the body shop applies anti-corrosion materials to the parts repaired or replaced.

NOTICE

Matte paint finish vehicle (if equipped)
In case of matte paint finish vehicles, it is impossible to modify only the damaged area and repair of the whole part is necessary. If the vehicle is damaged and painting is required, have your vehicle maintained and repaired by an authorized HYUNDAI dealer. Take extreme care, as it is difficult to restore the quality after the repair.

Bright-metal maintenance

- To remove road tar and insects, use a tar remover, not a scraper or other sharp object.
- To protect the surfaces of brightmetal parts from corrosion, apply a coating of wax or chrome preservative and rub to a high luster.
- During winter weather or in coastal areas, cover the bright metal parts with a heavier coating of wax or preservative. If necessary, coat the parts with non-corrosive petroleum jelly or other protective compound.

Underbody maintenance

Corrosive materials used for ice and snow removal and dust control may collect on the underbody. If these materials are not removed, accelerated rusting can occur on underbody parts such as the frame and floor pan, even though they have been treated with rust protection.

Thoroughly flush the vehicle underbody and wheel openings with lukewarm or cold water once a month, after off-road driving and at the end of each winter. Pay special attention to these areas because it is difficult to see all the mud and dirt. It will do more harm than good to wet down the road grime without removing it. The lower edges of doors, rocker panels, and frame members have drain holes that should not be allowed to clog with dirt; trapped water in these areas can cause rusting.



WARNING

After washing the vehicle, test the brakes while driving slowly to see if they have been affected by water. If braking performance is impaired, dry the brakes by applying them lightly while maintaining a slow forward speed.

Aluminum wheel maintenance

The aluminum wheels are coated with a clear protective finish.

- Do not use abrasive cleaner, polishing compound, solvent, or wire brushes on aluminum wheels.
- Clean the wheel when it has cooled.
- Use only a mild soap or neutral detergent, and rinse thoroughly with water. Also, clean the wheels after driving on salted roads.
- Do not wash the wheels with high-speed car wash brushes.
- Do not use any cleaners containing acid or alkaline detergents.

Corrosion protection

Protecting your vehicle from corrosion

By using the most advanced design and construction practices to combat corrosion, HYUNDAI produces vehicles of the highest quality. However, this is only part of the job. To achieve the long-term corrosion resistance your vehicle can deliver, the owner's cooperation and assistance is also required.

Common causes of corrosion

The most common causes of corrosion on your vehicle are:

- Road salt, dirt and moisture that is allowed to accumulate underneath the vehicle.
- Removal of paint or protective coatings by stones, gravel, abrasion or minor scrapes and dents which leave unprotected metal exposed to corrosion.

High-corrosion areas

If you live in an area where your vehicle is regularly exposed to corrosive materials, corrosion protection is particularly important. Some of the common causes of accelerated corrosion are road salts, dust control chemicals, ocean air and industrial pollution.

Moisture breeds corrosion

Moisture creates the conditions in which corrosion is most likely to occur. For example, corrosion is accelerated by high humidity, particularly when temperatures are just above freezing. In such conditions, the corrosive material is kept in contact with the vehicle surfaces by moisture that is slow to evaporate.

Mud is particularly corrosive because it is slow to dry and holds moisture in contact with the vehicle. Although the mud appears to be dry, it can still retain moisture and promote corrosion.

High temperatures can also accelerate corrosion of parts that are not properly ventilated so the moisture can be dispersed. For all these reasons, it is particularly important to keep your vehicle clean and free of mud or accumulations of other materials. This applies not only to the visible surfaces but particularly to the underside of the vehicle.

To help prevent corrosion

Keep your vehicle clean

The best way to prevent corrosion is to keep your vehicle clean and free of corrosive materials. Attention to the underside of the vehicle is particularly important.

- If you live in a high-corrosion area — where road salts are used, near the ocean, areas with industrial pollution, acid rain, etc.—, you should take extra care to prevent corrosion. In winter, hose off the underside of your vehicle at least once a month and be sure to clean the underside thoroughly when winter is over.
- When cleaning underneath the vehicle, pay particular attention to the components under the fenders and other areas that are hidden from view. Do a thorough job; just dampening the accumulated mud rather than washing it away will accelerate corrosion rather than prevent it. Water under high pressure and steam are particularly effective in removing accumulated mud and corrosive materials.
- When cleaning lower door panels, rocker panels and frame members, be sure that drain holes are kept open so that moisture can escape and not be trapped inside to accelerate corrosion.

Keep your garage dry

Don't park your vehicle in a damp, poorly ventilated garage. This creates a favorable environment for corrosion. This is particularly true if you wash your vehicle in the garage or drive it into the garage when it is still wet or covered with snow, ice or mud. Even a heated garage can contribute to corrosion unless it is well ventilated so moisture is dispersed.

Keep paint and trim in good condition

Scratches or chips in the finish should be covered with "touch-up" paint as soon as possible to reduce the possibility of corrosion. If bare metal is showing through, the attention of a qualified body and paint shop is recommended.

Bird droppings are highly corrosive and may damage painted surfaces in just a few hours. Always remove bird droppings as soon as possible.

Interior Care

Interior general precautions

Prevent caustic solutions such as perfume and cosmetic oil, from contacting the interior parts because they may cause damage or discoloration. If they do contact the interior parts, wipe them off immediately. See the instructions for the proper way to clean vehicle interior surfaces.

NOTICE

- **Never allow water or other liquids to come in contact with electrical/ electronic components inside the vehicle as this may damage them.**
- **When cleaning leather products (steering wheel, seats etc.), use neutral detergents or low alcohol content solutions. If you use high alcohol content solutions or acid/ alkaline detergents, the color of the leather may fade or the surface may get stripped off.**

Cleaning the upholstery and interior trim

Vehicle interior surfaces (if equipped)

Remove dust and loose dirt from interior surfaces with a whisk broom or a vacuum cleaner. If necessary, clean interior surfaces with a mixture of warm water and mild non-detergent cleaner (test all cleaners on a concealed area before use).

Fabric (if equipped)

Remove dust and loose dirt from fabric with a whisk broom or vacuum cleaner. Clean with a mild soap solution recommended for upholstery or carpets. Remove fresh spots immediately with a fabric spot cleaner. If fresh spots do not receive immediate attention, the fabric can be stained and its color can be affected. Also, its fire-resistant properties can be reduced if the material is not properly maintained.

NOTICE

Using anything but recommended cleaners and procedures may affect the fabric's appearance and fire-resistant properties.

Leather (if equipped)

- Features of seat leather
 - Leather is made from the outer skin of an animal, which goes through a special process to be available for use. Since it is a natural product, each part differs in thickness or density.
Wrinkles may appear as a natural result of stretching and shrinking depending on the temperature and humidity.
 - The seat is made of stretchable fabric to improve comfort.
 - The parts contacting the body are curved and the side supporting area is high which provides driving comfort and stability.
 - Wrinkles may appear naturally from usage. It is not a fault of the products.

NOTICE

- **Wrinkles or abrasions which appear naturally from usage are not covered by warranty.**
- **Belts with metallic accessories, zippers or keys inside the back pocket may damage the seat fabric.**
- **Make sure not to wet the seat. It may change the nature of natural leather.**
- **Jeans or clothes which could bleach may contaminate the surface of the seat covering fabric.**

- Caring for the leather seats
 - Vacuum the seat periodically to remove dust and sand on the seat. It will prevent abrasion or damage of the leather and maintain its quality.
 - Wipe the natural leather seat cover often with dry or soft cloth.
 - Use of proper leather protector may prevent abrasion of the cover and helps maintain the color. Be sure to read the instructions and consult a specialist when using leather coating or protective agent.
 - Light colored (beige, cream beige) leather is easily contaminated and the stain is noticeable. Clean the seats frequently.
 - Avoid wiping with wet cloth. It may cause the surface to crack.
- Cleaning the leather seats
 - Remove all contaminations instantly. Refer to instructions below for removal of each contaminant.
 - Cosmetic products (sunscreen, foundation, etc.)
Apply cleansing cream on a cloth and wipe the contaminated spot. Wipe off the cream with a wet cloth and remove water with a dry cloth.
 - Beverages (coffee, soft drink, etc.)
Apply a small amount of neutral detergent and wipe until contaminations do not smear.
 - Oil
Remove oil instantly with absorbable cloth and wipe with stain remover used only for natural leather.
 - Chewing gum
Harden the gum with ice and remove gradually.

Cleaning the seat belt webbing

Clean the belt webbing with any mild soap solution recommended for cleaning upholstery or carpet. Follow the instructions provided with the soap. Do not bleach or re-dye the webbing because this may weaken the seat belt.

Cleaning the interior window glass

If the interior glass surfaces of the vehicle become fogged (that is, covered with an oily, greasy or waxy film), they should be cleaned with glass cleaner. Follow the directions on the glass cleaner container.

NOTICE

Do not scrape or scratch the inside of the rear window. This may result in damage to the rear window defroster grid.

CALIFORNIA PERCHLORATE NOTICE

Perchlorate Material-special handling may apply, See: www.dtsc.ca.gov/perchlorate.

Notice to California Vehicle Dismantlers: Perchlorate containing materials, such as air bag inflators, seatbelt pretensioners and keyless remote entry batteries, must be disposed of according to Title 22 California Code of Regulations Section 67384.10 (a).